

ರೈಲು ಮೂಲಸೌಲಭ್ಯ ಅಭಿವೃದ್ಧಿ ಕಂಪನಿ (ಕರ್ನಾಟಕ) ನಿಯಮಿತ

रेल इन्फ्रास्ट्रक्चर डेवलपमेंट कंपनी (कर्नाटक) लिमिटेड

**Rail Infrastructure Development Company (Karnataka) Limited
(K-RIDE)**

(A Joint Venture of Govt. of Karnataka and Ministry of Railways)

TENDER DOCUMENT FOR THE WORK OF

“SHIFTING OF ELECTRICAL UTILITIES INFRINGING PROPOSED CORRIDOR-2 OF BENGALURU SUBURBAN RAIL PROJECT BETWEEN LOTTEGOLLAHALLI TO YESWANTPUR OF CHIKKBANAVARA TO BAIYYAPPANAHALLI SECTION”.

TENDER NO. K-RIDE/BSRP/17/2023, DATED: 10.02.2023

RAIL INFRASTRUCTURE DEVELOPMENT COMPANY (KARNATAKA) LIMITED

Samparka Soudha, 1st Floor,

Dr. Rajkumar Road,

Opposite Orion Mall,

Rajajinagar 1st Block, Bengaluru-560010

Tel +91-6366430945

Email: electrical.kride@gmail.com



TENDER DOCUMENT

(Through e-Tendering Mode)

Tender for the work of:

“SHIFTING OF ELECTRICAL UTILITIES INFRINGING PROPOSED CORRIDOR-2 OF BENGALURU SUBURBAN RAIL PROJECT BETWEEN LOTTEGOLAHALLI TO YESWANTPUR OF CHIKKBANAVARA TO BAIYYAPPANA HALLI SECTION”.

TENDER NO:	K-RIDE/BSRP/16/2022, Date: 12.01.2023
TENDER DOCUMENT CAN BE DOWNLOADED FROM	Date: 10/02/2023
PERIOD OF SALE OF TENDER DOCUMENT	NA
LAST DATE FOR SALE OF TENDER DOCUMENT	NA
LAST DATE AND TIME FOR RECEIPT OF BIDS	Date: 13/03/2023, IST 15:00 Hrs (Only electronic tender permitted.)
DATE AND TIME OF OPENING OF COVER ONE OF TENDER (TECHNICAL BID)	Date: 14/03/2023, IST 15:30 Hrs
PLACE OF OPENING OF COVER ONE OF TENDER (TECHNICAL BID)	The opening of the Technical Bid shall take place at e- procurement portal of K-RIDE i.e., https://eproc.karnataka.gov.in
PLACE OF OPENING OF COVER TWO OF TENDERS (FINANCIAL BID)	The opening of the Financial Bid shall take place at e- procurement portal of K-RIDE i.e., https://eproc.karnataka.gov.in
DATE AND TIME OF OPENING OF COVER TWO OF TENDERS	Will be intimated to the Qualified Tenderers through e-procurement portal.
ADDRESS FOR COMMUNICATION	JGM/ Electrical K-RIDE (Rail Infrastructure Development Company (Karnataka) Limited) #8, 1 st Floor, Samparka Soudha, Dr. Rajkumar Road, Opposite Orion Mall Rajajinagar 1 st Block, BENGALURU Tel – 91-6366430945 E Mail – electrical.kride@gmail.com

CONTENTS

SECTION NO.	DESCRIPTION	PAGE NO.
1	INVITATION FOR TENDERS (IFT)	01-06
2	INSTRUCTIONS TO TENDERERS (ITT)	07-45
3	QUALIFICATION INFORMATION/ BIDDING FORMS	46-91
4	FORM OF TENDER, LETTER OF ACCEPTANCE, NOTICE TO PROCEED WITH THE WORK AND AGREEMENT FORM ETC.,	92-97
5	CONDITIONS OF CONTRACT (CC)	98-121
6	CONTRACT DATA	122-127
7	PARTICULAR CONDITIONS OF CONTRACT	128-224
8A	EMPLOYER'S REQUIREMENT – GENERAL INFORMATION AND SCOPE OF WORK	225-257
8A-1	GENERAL REQUIREMENTS	258-263
8B	TECHNICAL SPECIFICATIONS	264-481
8C	EXPLANATORY NOTES	482-492
9	BILL OF QUANTITIES AND PAYMENT TERMS	493-495
10	FORMAT OF BANK GUARANTEE FOR SECURITY DEPOSIT ETC.,	496-512

SECTION: 1

NOTICE FOR INVITATION FOR TENDERS (IFT)

Rail Infrastructure Development Company (Karnataka) Limited

INVITATION FOR BIDS

(Through e-tendering mode)

Tender Notice No. **K RIDE/BSRP/17/2023**

Date: 10.02.2023

THE RAIL INFRASTRUCTURE DEVELOPMENT COMPANY (KARNATAKA) LIMITED (K-RIDE), having its corporate office, at #8, 1st Floor, Samparka Soudha, Dr. Rajkumar Road, Opposite Orion Mall, Rajajinagar 1st Block, Bengaluru-560010, India, which is a Joint Venture of Government of Karnataka and Ministry of Railways invites Bids from eligible Bids, for the construction of works detailed in the table below under **Single stage: Two tender document system (Technical Bid and Financial Bid)**.

SL. NO.	NAME OF WORK	APPROX. VALUE OF WORK (IN ₹ CRS)	TENDER SECURITY/EMD	PERIOD OF COMPLETION
1	2	3	4	5
1	“SHIFTING OF ELECTRICAL UTILITIES INFRINGING PROPOSED CORRIDOR-2 OF BENGALURU SUBURBAN RAIL PROJECT BETWEEN LOTTEGOLLAHALLI TO YESWANTPUR OF CHIKKBANAVARA TO BAIYYAPPANAHALLI SECTION”.	Rs.11.66Cr	Rs. 15,00,000/-	12 months

NOTE:

1. The Tenderers shall submit the tender through e - procurement portal. Tenderers should scan the registration copy; work done certificate and any other document and submit through online. More information can be had from website www.eproc.karnataka.gov.in
2. On the stipulated date of opening of Tenders, initially, only the Technical Bids are opened through Karnataka Public Procurement Portal. The Technical Bids shall be evaluated by the Employer in accordance with the stipulated Qualification and Evaluation criteria. No amendments or changes to the Technical Bids would be permitted after the opening of Technical Bids.
3. Tenderers who are qualified in the technical evaluation, their Price Bid shall be opened at a date and time advised by the Employer (K-RIDE) through e-tendering portal. The Price Bids are evaluated and the Contract is awarded to the Tenderer whose Tender has been determined to be the lowest evaluated substantially responsive tender.
4. Tenderers are advised to note the eligibility and minimum qualifying criteria specified in the Section 2: Instruction to Tenderers of the tender document.

5. Tenders must be accompanied by a Bid Security as per ITT 13.7 and Section 3: Qualification Information/Bidding Forms in any one of the forms as specified in the tender documents and shall have to be valid for 45 days beyond the validity of the tender. Any Tenders received without Bid security, shall be summarily rejected.
6. Incomplete Tender submission will be considered non-responsive and such Tenders shall not be considered for further evaluation.
7. Tender Documents can be downloaded free of cost from e-procurement portal i.e., <https://eproc.karnataka.gov.in> from 10/02/2023 and the Tenders must be submitted online via Karnataka Public Procurement Portal only.

Please note that drawings, if any, referred in the tender document, but not uploaded with the tender document, can be viewed in this office on any working day. The Tenderer can also have a copy of the same on payment of non-refundable cost of Rs. 5,000/- (Rupees Five Thousand only) by a e-Payment mode (credit card/debit card/net banking/UPI) in favour of **Rail Infrastructure Development Company (Karnataka) Limited**, Bangalore.

It will be the responsibility of the Tenderer who is submitting the Tender on downloaded Tender documents to check and see any Addendum/Corrigendum issued in this regard from the website from time to time and ensure submission of bid along with all Addendum/Corrigendum.

In case of any clarifications the Tenderer can visit the Rail Infrastructure Development Company (Karnataka) Limited Corporate Office Bengaluru at #8, 1st Floor, Samparka Soudha, Dr. Rajkumar Road, Opposite Orion Mall, Rajajinagar 1st Block, Bengaluru-560010. Tel. No.+91-6366430945.

8. Validity of Tender: Tenders shall remain valid for a period of **180 days** after the Tender submission deadline date prescribed by the employer. A Tender valid for a shorter period shall be rejected by the employer as non-responsive.
9. In exceptional circumstances, the Employer may request Tenderers to extend the period of validity of their Tenders. The request and the responses shall be made in writing. If a Tender security is requested in accordance with ITT 13, it shall also be extended up to the date mentioned in the letter of request for extension. A Tenderer may refuse the request without forfeiting its Tender security. A Tenderer granting the request shall not be required or permitted to modify its Tender.
10. If, the office happens to be closed on the date of opening of Tender, the Tenders will be opened on next working day at the same time and venue.
11. A Pre- Bid meeting will be held on 23/02/2023 at 11:30 Hrs. IST at the office of K-RIDE, Bangalore to clarify the issues if any and to answer questions on any matter that may be raised at that stage as stated in Clause - 8 of ITT of the Tender document.
12. Other details can be seen in Tender documents.

13. **REGISTRATION:**

- a. Tenderers are required to enroll on the e-tendering Portal (<https://eproc.karnataka.gov.in>) with clicking on the link "Tenderers Registration" on the e-tender Portal by paying requisite registration fee as applicable.
- b. As part of the enrolment process, the Tenderers will be required to choose a unique user name and assign a password for their accounts.
- c. Tenderers are advised to register their valid email address and mobile numbers as part of the registration process. These would be used for any communication with the Tenderer.
- d. Upon enrolment, the Tenderers will be required to register their valid Digital Signature Certificate (Only Class III Certificates with signing + encryption key usage) issued by any Certifying Authority recognized by CCA India with their profile.
- e. Only one valid DSC should be registered by a Tenderer. Please note that the Tenderers are responsible to ensure that they do not lend their DSC"s to others which may lead to misuse.
- f. Tenderers then logs in to the site through the secured log-in by entering their user ID/password and the password of the DSC / e-Token.
- g. The scanned copies of all original documents should be uploaded on portal.
- h. For any query regarding e-procurement on the Karnataka Public Procurement Portal, contact helpdesk number **+91-8046010000, +91-8068948777, support@eprochelpdesk.com**

14. SEARCHING FOR PROPOSAL DOCUMENTS

Once the Tenderers have selected the proposals they are interested in, the Tenderers can pay nonrefundable processing fee as per the Karnataka Public Procurement Portal.

15. PRECAUTIONS FOR SUBMITTING / PREPARATION OF PROPOSALS THROUGH E TENDERING PORTAL

- a. Tenderer, in advance, should get ready the proposal documents to be submitted as indicated in the proposal document / schedule and generally, they can be in PDF /JPEG formats.
- b. Tenderer should log into the website well in advance for the submission of the proposal so that it gets uploaded well in time i.e., on or before the proposal submission time. Bidder will be responsible for any delay due to other issues.
- c. The Tenderer has to digitally sign and upload the required proposal documents one by one as indicated in the tendering document.
- d. The server time (which is displayed on the consultant's dashboard) will be considered as the standard time for referencing the deadlines for submission of the proposals by the consultants, opening of proposals etc. The consultants should follow this time during proposal submission.

16. The Tenderer should furnish the Name of the individual / firm/ Company / Joint venture with address and telephone number with place of registration, year of incorporation etc.,
17. Tender by a joint venture of contractors is permitted subject to conditions indicated in tender document.
Note: Wherever the word JV/Consortium is mentioned there, it should be read as JV.
18. The application made by the firm / company / Joint Venture shall be signed by a person holding the power of attorney, in which case the Tenderer shall furnish a copy of power of attorney.
19. Bid through any other mode shall not be entertained. However, power of attorney and JV agreement etc., shall be submitted by the bidder on or before submission date and time.

20. **Employees Provident Fund Registration Certificate**

The Contractor shall furnish EPF Registration Certificate before entering into agreement in the event of award of work to them after tender, subject to compliance with the following conditions:

- a) If the contractor is registered already with the EPF authorities, they should produce a copy of the EPF Registration Certificate.
 - b) If not registered with the EPF authorities, the Tenderer should produce an undertaking at the time of participating in the tender that he shall within 7 days of the close of every month submit a Statement to Engineer showing the recoveries of contribution in respect of Employees by or through him and shall also furnish such information as the Engineer is required to furnish under the provisions of the Scheme to the Commissioner EPF.
 - c) However, having given an undertaking to this effect if the Contractor does not furnish the information, the Employer will deduct the necessary amount from the amount due to the Contractor. Notwithstanding the above, the Contractor will be liable for any consequential penalty /damages levied by the EPF authorities.
21. The necessary certificates / documents in support fulfilling qualifying criteria stipulated separately shall be scanned and attached to e-procurement document. The original documents if required by the Employer shall be produced whenever asked by Employer on Technical Bid/ Financial Bid.
 22. The intending Tenderers are advised to visit the site of work before attending the Pre- Bid meeting and also before submitting the Tenders.
 23. The qualification criteria as indicated in bid document should be met by the intending Tenderers.
 24. Tenderers shall not be under a declaration of ineligibility for corrupt and fraudulent practices issued by the Govt. of Karnataka, Govt of India and any PSUs thereof.
 25. **Pre-bid meeting will be held on 23/02/2023 at 11.30AM in the office of K-RIDE Bangalore.**
 26. The conditional Tenders will not be accepted.
 27. The Employer is not responsible for any delay in accessing Karnataka Public Procurement Portal.

28. Contract prices shall be inclusive of all Taxes, Duties etc., The rates quoted by the tenderer must be inclusive of all Taxes, Duties etc.,
29. The Employer reserves the right to either postpone or to cancel the entire process of tender.
30. If Employer wishes to engage third party consultants for quality control assessment, apart from the Employer quality control and field tests, the Tenderer should co-operate with both Quality control authorities and the third party.
31. Building and other construction workers welfare: The Tenderer shall subscribe 1% of gross amount of each bill payable to him in respect of contract to the building and other construction workers welfare cess as per GO No: LD 300 LET 2006, Bangalore, dated: 18-01-2007. The amount of subscription will be recovered out of payable amount to him in each bill. This component is deemed to have been included in the quoted rate.
32. **Last Date of Receipt and opening of Bids:** The completed Tenders must be submitted through Karnataka Public Procurement Portal <https://eproc.karnataka.gov.in> not later than **15.00 Hrs** on **13/03/2023** and shall be opened on **14/03/2023** at **15.30 Hrs**. K-RIDE will not be responsible for any delays in the receipt of Tender by K-RIDE. Late Tenders (received after stipulated date and time of submission of Tenders) shall not be accepted under any circumstances. K-RIDE reserves the right to accept/reject any or all proposals without assigning any reason thereof.
33. Any suit or application, arising out of any dispute or differences on account of this tender shall be filed in a competent court at Bengaluru, Karnataka only and no other court or any other district of the country shall have any jurisdiction in the matter.
34. **Address for Communication:** Interested eligible Tenderers may obtain further information from the following address:

JGM/Electrical,
Rail Infrastructure Development Company (Karnataka) Limited,
#8, 1st Floor, Samparka Soudha, Dr. Rajkumar Road, Opposite Orion Mall
Rajajinagar 1st Block, Bengaluru-560010
Tel +916366430945.
E-mail: electrical.kride@gmail.com

For any Query regarding e tendering portal/ Tender submission please contact
helpdesk Number [+91-8046010000](tel:+91-8046010000), [+91-8068948777](tel:+91-8068948777)
Email: support@eprochelpdesk.com

SECTION – 2

INSTRUCTIONS TO TENDERERS (ITT)

SL.NO	DESCRIPTION	PAGE NO
	A. GENERAL	
1	SCOPE OF TENDER	9
2	ELIGIBLE TENDERERS	9
3	QUALIFICATION OF THE TENDERER	12
4	ONE TENDER FOR TENDERER	18
5	COST OF TENDERING	18
6	SITE VISIT	18
	B. TENDER DOCUMENTS	
7	CONTENT OF TENDER DOCUMENTS	19
8	CLARIFICATION OF TENDER DOCUMENT	19
9	AMENDMENT OF TENDER DOCUMENTS	20
	C. PREPARATION OF TENDERS	
10	DOCUMENTS COMPRISING THE TENDER	21
11	TENDER PRICES	21
12	TENDER VALIDITY	22
13	EARNEST MONEY DEPOSIT	22
14	FORMAT AND SIGNING OF TENDER	23
	D. SUBMISSION OF TENDERS	
15	SEALING AND MARKING OF TENDERS	25
16	DEADLINE FOR SUBMISSION OF TENDERS	25
17	LATE TENDERS	25
18	MODIFICATION AND WITHDRAWAL OF TENDERS	25
	E. TENDER OPENING AND EVALUATION	
19	OPENING OF FIRST COVER (DOCUMENT) OF ALL TENDERS AND EVALUATION TO DETERMINE QUALIFIED TENDERERS	26
20	OPENING OF SECOND COVER (DOCUMENT) TENDERS OF QUALIFIED TENDERS AND EVALUATION	26
21	PROCESS TO BE CONFIDENTIAL	27
22	CLARIFICATION OF TENDERS	27
23	EXAMINATION OF TENDERS AND DETERMINATION OF RESPONSIVENESS	27
24	CORRECTION OF ERRORS	27
25	EVALUATION AND COMPARISON OF TENDERS	28
	F. AWARD OF CONTRACT	
26	AWARD CRITERIA	29
27	EMPLOYER'S RIGHT TO ACCEPT ANY TENDER AND TO REJECT ANY OR ALL TENDERS	29
28	NOTIFICATION OF AWARD AND SIGNING OF AGREEMENT	29
29	PERFORMANCE SECURITY	29
30	ADVANCE PAYMENT AND SECURITY	30
31	CORRUPT OR FRAUDULENT PRACTICES	30
32	PURCHASE PREFERENCE TO MAKE IN INDIA	31
33	APPEAL	31

SECTION 2: INSTRUCTIONS TO TENDERERS (ITT)
TABLE OF CLAUSES

A. GENERAL

1. SCOPE OF THE TENDER:

1.1 THE RAIL INFRASTRUCTURE DEVELOPMENT COMPANY (KARNATAKA) LIMITED (K-RIDE), Having its Corporate office, at #8, 1st Floor, Samparka Soudha, Dr. Rajkumar Road, Opposite Orion Mall, Rajajinagar 1st Block, Bengaluru-560010, India, which is a Joint Venture of Government of Karnataka and Ministry of Railways invites Tenders from Eligible Tenderers, for the construction of works details as given in the invitation for the Tenders (IFT). The tenderers may submit the tenders for the works detailed in the IFT.

2. ELIGIBLE TENDERERS:

2.1 The Tenderers shall not be under a declaration of ineligibility for corrupt and fraudulent practices issued by Govt. of Karnataka, Govt of India and PSUs.

2.2 JOINT VENTURES:

Tendering by a joint venture of Contractors is permissible, only for Tenders with Estimated value greater than 10 Cr, subject to following conditions:

- a. If the Applicant comprises a number of firms combining their resources in a joint venture, the legal entity constituting the joint venture and the individual partners in the joint venture shall be registered after award of work and shall not be under a declaration of ineligibility for corrupt and fraudulent practices issued by GOK.

Note: The Joint Venture agreement needs to be registered under “The Registration Act 1908” after the issue of LOA. Incorporation of the JV is not expected.

- b. The joint venture must satisfy collectively the Qualification criteria. For this purpose, the following data of each member of the joint venture may be added together to meet the collective qualifying criteria:
- i. Average annual turnover (sub clause 3.2a).
 - ii. Particular experience including key production rates. (Sub clause 3.2b & c).
 - iii. Financial means (sub clause 3.3b liquid assets, 3.6 assessed available Tender capacity & the audited balance sheets or other financial statements acceptable to the employer, for the last five years shall be submitted and must demonstrate current soundness of the applicant’s financial position and indicates its prospective long-term profitability).
 - iv. Personnel capabilities (sub clause 3.3c: List of minimum key staff/position required during the contract implementation).
 - v. Equipment capabilities (sub clause 3.3a: own/lease equipment’s).

- c. Each partner must satisfy the following criteria individually:
- i. General construction experience for the period of years stated in Tender document (Instructions to Tenderers: The intending Tenderer/firm/company/ joint venture shall provide evidence that it has been actively engaged in execution of **“Works of erection/laying and commissioning of overhead lines/underground cables for 11 kV or above with or without supply of overhead line/cables”** work for at least for a period of 5 years prior to the submission of application.) (From FY: 17-18 to FY: 21-22).
 - ii. Adequate sources to meet financial commitments on the other contracts (Sub clause 3.5: Accessed availed Tender capacity).
 - i. **Financial Soundness (Instructions to Tenderers:** The intending Tenderer/firm/company shall provide the audited balance sheets or other financial statements acceptable to the employer for the last five years and must demonstrate the current soundness of the applicant’s financial position and indicate its prospective long-term profitability. If deemed necessary, the employer shall have the authority to make enquiries with the applicants’ bankers).
 - ii. **Litigation History (Instructions to Tenderers:** The intending Tenderer/firm/company/ joint venture shall provide accurate information on the related application form about any litigation or Arbitration resulting from contracts completed or on going under its execution over the last five years. The consisting history of awards against the tenderer or any partner of a joint venture may result in failure of the application).
 - iii. In accordance with the above, the Application shall include all related information required for individual partners in the joint venture
- d. **Joint venture is restricted to 3 (Three) number of partners.** One of the partners, who is responsible for performing a key function in contract management or is executing a major component of the proposed contract, shall be nominated as being in charge during the tendering periods and, in the event of a successful tender, during contract execution. The partner in charge shall be authorized to incur liabilities and receive instructions for and on behalf of any and all partners of the joint venture; this authorization shall be evidenced by submitting a power of attorney signed by legally authorized signatories of all the partners.
- e. All partners of the joint venture shall be legally liable, jointly and severally, during the tendering process and for the execution of the contract in accordance with the contract terms, and a statement to this effect shall be included in the authorization mentioned under Sub-Clause 2.2(d) above. **To enable the above, each of the partners of the joint venture shall meet not less than 25% of the qualifying criteria specified for Average annual turnover and Line of credit / liquid assets. All members of the joint venture must have experience in execution of similar work.**
- f. A copy of the Joint Venture Agreement (JVA) entered into by the partners shall be submitted with the Application. Pursuant to Sub-Clauses 2.2(c) to 2.2(f) above, the JVA shall include among other things: the JV’s objectives; the proposed management structure; the contribution of each partner to the joint venture operations; the commitment of the partners to joint and several liability for due performance; recourse/sanctions within the JV in the event of default or withdrawal of any partner; and arrangements for providing the required indemnities.

The lead partner shall enter into a Joint Venture agreement of Rs. 200.00 stamp paper in the prescribed format which shall be concluded prior to Tender and enclosed to the Tender document J.V. Partner shall not enter in to multiple JV's with different Tenderers of the same work.

- g. The qualification of a joint venture does not necessarily qualify any of its partners to tender individually or as a partner in any other joint venture or association. In case of dissolution of a joint venture prior to the submission of tenders, any of the constituent firms may qualify if they meet all of the qualification requirements, subject to the return approval of the employer. Individual members of a dissolved joint venture may participate as sub-contractor to qualified applicants, subject to the provisions mentioned below:
- “No firm can be a sub-contractor while submitting a tender individually or as a partner of a joint venture in the same tendering process. A firm, if acting in the capacity of sub-contractor in any tender, may participate in more than one tender, but only in that capacity. A tenderer who submits, or participates in, more than one tender will cause all the proposals in which the tender has participated to be disqualified.”
 - A firm shall submit only one Tender in the same Tendering process, either individually as a Tenderer or as partner of Joint Venture.
 - The necessary certificates/documents in support of pre-qualification criteria fulfilled as stipulated shall be scanned and attached to e-tender document. Scanned signature of the Tenderer/authorized representatives of the Tenderer shall be attached while uploading the Tender document.

Any Tenderer who is otherwise technically qualified withdraws from the Tender process at any stage before a final decision is taken on the tender, the EMD of such Tenderer shall be forfeited, the name of such Tenderer shall be removed from the category list of contractors at least for a minimum period of one year in K-RIDE beside making such Tenderer liable for blacklisting.
 - Tenders submitted by all Tenderers in the process of Tender evaluation will be opened even if the Tenderer withdraws from the Tender process by not submitting the original documents for verification or for any other reasons and the prices quoted by them will be looked into, to ascertain if there is collision amongst the Tenderers to determine the competitiveness of the L1 price quoted by other Tenderers, as per the decision by the K-RIDE.
 - Prior to awarding of the work, the Lowest (L-1) Tenderer should produce the original documents in support of the uploaded documents to enter in to the agreement. If the lowest Tenderer (L-1) does not produce the original documents for entering into the agreement then his Tender can be treated as non-responsive Tender as per clause 26(4) of the KTPP Rules. The name of the Tenderers who do not produce the original documents shall be removed/debarred from the select list of K-RIDE enrollment and barred from participation in any of the tenders to be invited by K-RIDE a part from forfeiting the EMD paid through e-cash.
 - The bidder, JV Partner shall not be under Corporate Debt Restructuring (CDE)/ Strategic Debt Restructuring (SDR) or Bureau of Industrial & financial reconstruction (BIFR) in last

5 years to bid submission date. In this regard, the bidder shall submit along with bid, a certificate with a declaration that, the bidder is not under CFR/SDR or BIFR.

- Further information about e-tendering can be had from Karnataka Public Procurement Portal <http://eproc.karnataka.gov.in>

3. QUALIFICATION OF THE TENDERER.

3.1 All the tenderers shall provide the requested information accurately and sufficient details in section 3: Qualification information. The Joint Venture to be formed prior to the Bidding.

Pre-qualification will be based on Applicants meeting all the following minimum pass–fail criteria regarding their general and particular construction experience, financial position, personnel and equipment capabilities, and other relevant information as demonstrated by the Applicant's responses in the Information Forms attached to the Letter of Application. Additional requirements for joint ventures are given in para 2.2

3.2 The following qualification criteria should be met by the intending Tenderers.

a)

1. The intending Tenderer/firm/ company should possess valid class-1 Electrical Contractor License.
2. Required average annual turnover (in all contractual works): The intending Tenderer/firm/ Company/Joint Venture should have achieved a **MINIMUM AVERAGE ANNUAL CONSTRUCTION TURNOVER of Rs.23.32 Crores in last five financial years from 2017-18 to 2021-22.**

NOTE: The Tenderers shall submit certificates to this effect which may be **attested certificates** from the concern **departments/ Client or Audited balance sheet** duly certified by the statutory Auditor/ certificate from Chartered Accountant duly supported by audited balance sheet. The Turnover certificate duly certified by statutory Auditor should be uploaded. Financial turnover of previous years will be given a weightage of 10% per year or part thereof up to the month previous to the Bid submission month as indicated in qualification information (Tender Forms) Form FIN-2 based on the rupee value to bring them to current FY: 2022-23 price value.

- b) The Tenderer/Firm/company/JV should have satisfactorily completed at least one similar work such as “Works of erection/laying and commissioning of overhead lines/underground cables for 11 kV or above with or without supply of overhead line/cables” of value not less than Rs.5.83 Crores at current FY: 2022-23 price level in the last five financial years. (FY 2017-18 to FY 2021-22).

NOTE:

1. The criteria above applies to the Individual Tenderer/Firm/company/Joint venture also. Certificate regarding the same duly signed by an officer not below the rank of the Executive Engineer to be submitted along with the technical Tender.
2. Similar work is defined as below:
Work of execution of “Works of erection/laying and commissioning of overhead lines/underground cables for 11 kV or above with or without supply of overhead line/cables”.

3. The contract is considered as completed if 90% or more of the work is physically completed which is to be substantiated by a certificate from the Employer who has awarded the contract to the Bidder and the contract amount so received should be equal to or more than the minimum value as per eligibility criteria 3.2 (b).
 4. For completed works, the value of work done shall be updated to current FY 2022-23 price level assuming 10% inflation for Indian rupees every year or part thereof up to the month previous to the Bid submission month. Credentials if submitted in foreign currency shall be converted into Indian currency i.e., Indian Rupee as under: Bids will be compared in Indian Rupees only. The exchange rate of foreign currency shall be applicable 28 days before the tender submission date. For conversion of foreign currency to Indian Rupee exchange rates published by Financial Benchmarks Private limited (www.fbil.org.in) 28 days before the date of bid submittal will be considered. In case the particular day happens to be a holiday the exchange rate published on the next working day will be considered. In case of works in foreign currency the effect of inflation is considered as included, as the exchange rate prevailing 28 days before tender submission is being considered for conversion to Indian Rupees.
 5. In case of JV/Consortium, full value of the work, if done by the same JV shall be considered. However, if qualifying work (s) done by them in JV/Consortium having different constituents, then the value of work as per their percentage participation in such JV/Consortium shall be considered.
- c) **The intending Tenderer / firm/ company / Joint Venture should have executed all the components within last five financial years and Each component should have been executed in any one year (Any continuous 12 months).**

Component No.	Nature of Work	Minimum component of work
1	Construction / providing of HT / LT overhead / Underground power lines	1 km

NOTE: -

1. The criteria above applies to the Individual Tenderer/Firm/ company / Joint Venture also. Certificate regarding the same duly signed by an officer not below the rank of the Executive Engineer should be submitted along with the technical Tender.
2. The qualifications, capacity, and resources of proposed subcontractors will not be taken into account in assessing those of individual or joint venture Applicants, unless they are named specialist subcontractors.
 - Replace CA audit with Statutory Auditor wherever applicable, except in qualification of experts.

3.3 Each Tenderer should further demonstrate:

- 3.3 a) **KEY PLANT AND EQUIPMENT:** Availability by owning at least 50% of the required following key and critical equipment's for this work and the remaining 50 % can be deployed on lease/hire for all works provided, the relevant documents (Commitment agreements etc.) for availability for this work are to be furnished:

The intending Tenderer/firm/company/Joint venture should furnish details of ownership / lease certificates of the following minimum requirement of machineries:

PLANT AND EQUIPMENT

(I) **KEY AND CRITICAL EQUIPMENTS**

Sl.no	Item Description	Unit	Qty
1	Welding Machine	No's	1
2	Electric Hand Driller	No's	3
3	Digital Multi meter	No's	2
4	Insulation Megger	No's	2
5	Digital Earth Tester	No's	2
6	Ladder	No's	4
7	Hand Tool Kit	No	1
8	Crimping Tool	Each	1
9	Set of Tool Socket Spanner	No	1

(II) **Other Plant and equipment to be deployed (The Tenderer has to furnish the details of Own basis and Lease/Hire basis for the following equipment)**

Sl.no	Item Description	Unit	Qty
1	Tractor	No's	1
2	Crane	No's	1
3	Multi utility vehicle (Bolero)	No's	1

- 3.3 b) **LIQUID ASSETS:** The Tenderer / firm/company/Joint Venture should furnish details of liquid assets and or availability of credit facilities of Rs.3.88 Crores for the work mentioned above for meeting the required funds in the form of own funds /credit lines / certificate from scheduled Nationalized Bank.

The Bidder should have access to or has available liquid assets, lines of credit and other financial means to meet cash flow. The audited balance sheet and/or banking reference certified

by Chartered Accountant with their stamp, signature and membership number shall be submitted by the Tenderer along with the Tender.

Banking reference should contain in clear terms the amount that bank will be in position to lend for this work to the applicant/member of the joint venture/Consortium. In case the Net Current Assets (as seen from the balance sheet) are negative, only the banking references will be considered. Otherwise, the aggregate of Net Current Assets and submitted banking references will be considered for working out the Liquidity.

The banking reference should be, from a scheduled Bank in India it should not be more than three months old as on date of submission of Bids.

In case of JV firm's overall liquidity of JV firm shall be assessed by arithmetic sum of liquidity of all members of JV as specified in JV matrix.

- 3.3 c) LIST OF MINIMUM KEY TECHNICAL PERSONNEL:** List of Minimum Key Technical personnel required for the work are as under and should be enrolled in company/firm/Joint venture under Employment register and document should be uploaded. The Contractor shall have a competent team of Managers, Engineers, Technical staff etc. so as to complete the work satisfactorily as per various requirements of the contract. The Key Positions not limited to and corresponding qualification and experience are as under:

S. No	Position	Minimum No. of Personnel	Qualification	Minimum Experience in Similar Work [years]
1	Sr. Engineers	1	Graduate in Electrical Engg.	Min. 5 Years and above
2	Sr. Engineers	1	Diploma in Electrical Engg.	Min. 10 years for Diploma
3	Technicians/ Electricians	3	ITI in Electrician	Min. 5 years of experience

Note: The CV's to be given for Serial No. 1 as per Form-6 of section-3 and Serial No. 1 to 3 the details to be given as per Form-5 of section-3 (Qualification information /Bidding Forms).

- 3.4 To qualify for a package of contracts made up of this and other contracts for which tenders are invited in this IFT, the Tenderer must demonstrate having experience and resources to meet the aggregate of the qualifying criteria for the individual contracts.**

- 3.5 Sub-contractors' experience and resources shall not be taken into account in determining the Tenderer's compliance with the qualifying criteria**

3.6 BID CAPACITY: Tenderers who meet the above specified minimum qualifying criteria, will only be qualified, if their available tender capacity is more than the total tender value. The available tender capacity will be calculated as under:

Assessed available tender capacity = $(A*N*1.5 - B)$ Where

A = Maximum value of works executed in any one year during the last five financial years updated to the current price level @10% per year.

N = Number of years prescribed for completion of the works for which tenders are invited.

B = Value of existing commitments and on-going works to be completed during the period of completion of the work for which tenders are invited.

The statements showing the value of existing commitments and on-going works as well as the stipulated period of completion remaining for each of the works listed should be countersigned by the Employer in charge not below the rank of an Executive Engineer or equivalent.

Note: Enclose Certificate(s) from Engineer(s) In charge (not below the rank of Executive Engineer) for value of outstanding work. In case it is not feasible to furnish certificate from all the units the bidder should record the following certificate on Fin-3:

“Certified that current commitments on all the contracts have been awarded or for which a letter of intent or acceptance has been received or for the works in progress or the works approaching completion, value of outstanding work has been indicated in the above table correctly. It is further certified that if later on the employer discovers that information provided in the table is incorrect then the employer will treat our bid invalid and it will be liable for rejection”.

3.7 NETWORTH: The Bidder's net worth for the last financial year calculated as the difference between total assets and total liabilities **should be Positive.**

3.8 Even though the Tenderers meet the above criteria, they are subject to be disqualified if they have:

- made misleading or false representations in the forms, statements and attachments submitted in proof of the qualification requirements; and/or
- record of poor performance such as abandoning the works, not properly completing the contract, inordinate delays in completion, litigation history, or financial failures etc.; and/or
- participated in the previous Tender for the same work and had quoted unreasonably high tender prices and could not furnish rational justification.

3.9 ELIGIBILITY CRITERIA TABLE/MATRIX:

Requirement	Single Entity	Joint Venture			Submission Requirements
		Lead Partner	Other Partners	All partners combined	
Clause: 3.2.(a).2 MINIMUM AVERAGE ANNUAL CONSTRUCTION TURNOVER	Must meet the requirement	Must meet 50% of the requirement	Must meet 25% of the requirement	Must meet the requirement	Form FIN-2
Clause: 3.2 (b) One Similar work	Must meet the requirement	Must meet the requirement	Must have experience in similar work.	Must meet the requirement	Form at para 1.3/section:3
Clause: 3.2 (c) Construction/ providing of HT/ LT overhead/Underground power lines- 1km	Must meet the requirement	All Partners Combined Must Meet requirement			Form at para 1.4/section:3
Clause: 3.3.a (I) Key and Critical Equipment's	Must meet the requirement	All Partners Combined Must Meet requirement			Form at para 1.6/section:3
Clause: 3.3.a (II) Other plant and Equipment's	Must meet the requirement	All Partners Combined Must Meet requirement			Form at para 1.6/section:3
Clause: 3.3(b) Liquid Asset	Must meet the requirement	Must meet 50% of the requirement	Must meet 25% of the requirement	Must meet the requirement	Form at para 1.10/section:3
Clause: 3.3(c) Minimum Key Technical Staff	Must meet the requirement	All Partners Combined Must Meet requirement			Form No.5 & 6 of Section 3
Clause: 3.6 Bid capacity	Must meet the requirement	All Partners Combined Must Meet requirement			Form at para 1.5/section:3 and Form FIN-3/section:3
Clause: 3.7 Net worth	Must meet the requirement	Must meet the requirement	Must meet the requirement	Must meet the requirement	Form FIN-1/section:3

3.10 The applicant must attach with their application, a note giving a general description on the approach to the construction methods, technologies, quality assurance schemes proposed, deployment schedule of equipment proposed to be used, etc., for ensuring completion of the work as per specifications within the desired time-frame.

4. ONE TENDER PER TENDERER:

4.1 Each tenderer shall submit only one tender for one package. A tenderer who submits or participates in more than one Tender (other than as a sub-contractor or in cases of alternatives that have been permitted or requested) will cause all the proposals with the Tenderer's participation to be disqualified.

5. COST OF TENDERING:

5.1 The tenderer shall bear all costs associated with the preparation and submission of his tender, and the Employer will in no case be responsible and liable for those costs.

6. SITE VISIT:

6.1 The Tenderer at his own responsibility and risk is encouraged to visit and examine the Site of Works and its surroundings and obtain all information that may be necessary for preparing the Tender and entering into a contract for construction of the Works. The cost of visiting the Site shall be at the Tenderer's own expense.

K-RIDE

B -TENDER DOCUMENTS

7. CONTENT OF TENDER DOCUMENTS

7.1 The set of tender documents shall have all the Section given in content page.

8. CLARIFICATION OF TENDER DOCUMENTS

8.1 A prospective tenderer requiring any clarification of the tender documents may notify the Employer in writing or by cable (hereinafter "cable" includes telex, E-Mail and facsimile) at the Employer's address indicated in the invitation to tender. The Employer will respond to any request for clarification which he receives earlier than the date mentioned in the e-procurement portal of Karnataka for queries. Copies of the Employer's response will be forwarded to all purchasers of the tender documents, including a description of the enquiry but without identifying its source.

8.2 Pre-tender meeting:

8.2.1 The tenderer or his authorized representative is invited to attend a pre-tender meeting which will take place at office of **K-RIDE Bangalore**.

Venue: #8, 1st Floor, Samparka Soudha, Dr. Rajkumar Road,
Opposite Orion Mall, Rajajinagar 1st Block,
Bengaluru-560010
Tel +91-6366430945

Date: 23/02/2023, **Time:** IST 11.30 Hrs.

8.2.2 The purpose of the meeting will be to clarify issues and to answer questions on any matter that may be raised at that stage.

8.2.3 The tenderer is requested to submit any questions in writing or by cable to reach the Employer not later than one week before the meeting.

8.2.4 Minutes of the meeting, including the text of the questions raised (without identifying the source of enquiry) and the responses given will be published without delay to all purchasers of the tender documents. Any modification of the tender documents listed in Sub-Clause 7.1 which may become necessary as a result of the pre-tender meeting shall be made by the Employer exclusively through the issue of an Addendum pursuant to Clause 9 and not through the minutes of the pre-tender meeting.

8.2.5 Non-attendance at the Pre-Tender meeting will not be a cause for disqualification of a Tenderer.

9. AMENDMENT OF TENDER DOCUMENTS

- 9.1 Before the deadline for submission of Tenders, the Employer may modify the tender documents by issuing addendum
- 9.2 Any corrigendum / addendum issued shall be part of the tender documents and shall be made available on the website or e-portal. The Provisions in corrigendum /addenda shall take priority over the Tender Documents issued previously.
- 9.3 To give prospective Tenderers reasonable time in which to take an addendum into account in preparing their tenders, the Employer shall extend as necessary the deadline for submission of Tenders, in accordance with Sub-Clause 16.2 below.

K-RIDE

C. PREPARATION OF TENDERS

10. DOCUMENTS COMPRISING THE TENDER

10.1 The Tender submitted by the Tenderer shall be in two covers (documents) and shall contain the documents as follows:

10.1.1 First Cover (Document):

- Earnest Money Deposit/Scanned copy of Bank Guarantee (B.G) for balance Earnest Money Deposit;
- Qualification Information as per formats given in Section 3;

10.1.2 Second Cover (Document):

- The Tender (in the format indicated in Section 4) (as per Karnataka Public Procurement Portal)
- Priced Schedule (Section 9); online through Karnataka Public Procurement Portal, no hardcopy of commercials should be attached or disclosed. (as per Karnataka Public Procurement Portal)
- And any other materials required to be completing and submitting by Tenderers in accordance with these instructions. The documents listed under Sections 3, 4, 6 and 9 shall be filled in without exception.

10.2 DELETED

11. TENDER PRICES

11.1 The contract shall be for the whole works as described in Sub-Clause 1.1, based on the price Schedule submitted by the Tenderer.

11.2 The Tenderer shall fill the percentage and total amount (both in figures and words) for each schedule of the Works described in the Price Schedule. Corrections, if any, shall be made by crossing out, initialing, dating and rewriting. Schedule for which no amount or lumpsum price is entered by the tenderer will not be paid by the employer when executed and shall be deemed to be covered in the priced schedule.

11.3 Contract prices shall be inclusive of all Taxes, Duties etc., The rates quoted by the tenderer must be inclusive of all Taxes, Duties etc.,

11.4 The percentage quoted by the Tenderer shall be subject to adjustment during the performance of the Contract in accordance with the provisions of Clause of the Conditions of Contract.

12. TENDER VALIDITY

12.1 Tenders shall remain valid for a period not less than **one hundred and eighty days** after the deadline date for tender submission specified in Clause 16. A tender valid for a shorter period shall be rejected by the Employer as non-responsive.

- 12.2 In exceptional circumstances, prior to expiry of the original time limit, the Employer may request that the Tenderers may extend the period of validity for a specified additional period. The request and the Tenderers' responses shall be made in writing or by cable. A Tenderer may refuse the request without forfeiting his earnest money deposit. A Tenderer agreeing to the request will not be required or permitted to modify his tender, but will be required to extend the validity of his earnest money deposit for a period of the extension, and in compliance with Clause 13 in all respects.

13. EARNEST MONEY DEPOSIT (TENDER/BID SECURITY)

- 13.1 Earnest Money Deposit/ Tender security (as per Karnataka Public Procurement Portal). The Tenderer shall furnish, as part of his tender, earnest money deposit in the amount as shown in column 4 of the Table of IFT for this particular work. This earnest money deposit shall be in favour of Rail Infrastructure Development Company (Karnataka) Limited Payable at Bangalore and may be in the form of as mentioned in Clause 13.7 of ITT (section-2).
- 13.2 Instruments having fixed validity issued as earnest money deposit for the tender shall be valid for 45 days beyond the validity of the tender.
- 13.3 Any tender not accompanied by an acceptable earnest money deposit and not secured as indicated in Sub-Clauses 13.1 and 13.2 above shall be rejected by the Employer as non-responsive.
- 13.4 The earnest money deposit of unsuccessful Tenderers will be returned within 30 days of the end of the tender validity period specified in Sub-Clause 12.1.
- 13.5 The earnest money deposit of the successful Tenderer will be discharged when the Tenderer has signed the Agreement and furnished the required Performance Security.
- 13.6 The earnest money deposit may be forfeited:
- (A) If the Tenderer withdraws the Tender after tender opening during the period of tender validity;
 - (B) If the Tenderer does not accept the correction of the Tender Price, pursuant to Clause 24; or
 - (C) In the case of a successful Tenderer, if the Tenderer fails within the specified time limit to
 - (i) sign the Agreement; or
 - (ii) furnish the required Performance Security

14. FORMAT AND SIGNING OF TENDER

Tenderer shall submit the Tender electronically before the submission date and time published in Karnataka Public Procurement Portal. The Tenderer must submit Technical and Financial Tender as described in ITT.

All pages of the tender where entries or amendments have been made shall be initialed by the person signing the tender. The Tender shall contain no alterations or additions, except those to comply with instructions issued by the Employer, or as necessary to correct errors made by the Tenderer, in

which case such corrections shall be initialed by the person signing the Tender.

Language of Tender	The language of the Tender: English
Technical Tender	Alternative technical solutions are not permitted.
Technical Tender Documents	All the Forms of Section 3: Qualification Information/Bidding Forms.
Alternative Bids/Tenders	Alternative Bids are not permitted.
Currencies of Tender and Payment	The amount shall be quoted by the Tenderer entirely in Indian Rupees (INR). For Evaluation and comparison purposes, the currencies of the Tender shall be converted in to Indian Rupees.
Any amendments such as interlineations, erasures, or overwriting shall be valid only if they are signed or initialed by the Person signing the Tender	<p>The written confirmation of authorization to sign on behalf of the Tenderer shall consist of:</p> <ol style="list-style-type: none"> In case of Private/Public Companies, a POA from the Director of the Company who has been authorized by the Board of Directors through resolution to sign on behalf of the Company. Copy of Board Resolution shall also be submitted. In case of proprietorship Tenderers, Power of Attorney by the Proprietors. In case of partnership Tenderers, Power of Attorney duly signed by all the partners. In case of Limited Liability Partnership (LLP), a POA from the Director of the Company who has been authorized by the Board of Directors through resolution to sign on behalf of the Company. Copy of Board Resolution shall also be submitted. In case of Joint Venture, Power of Attorney duly signed by individual partners to the Lead partner as per the form given in Section-4 with stipulated documents.

The Bid shall be digitally signed by using class-III digital signature of a person who is dully authorized to sign on behalf of the bidder. This authorization shall consist of a written confirmation as specified in the BDS and shall be attached to the bid. The name and position held by each person signing the authorization must be typed or printed below the signature. If either the Letter of Technical Bid or Letter of Price Bid or Bid-Security Declaration (if applicable) is not signed, the Bid shall be rejected. All pages of the bid, except for un-amended printed literature, shall be signed or initialed by the person signing the bid.

- If the Tender is submitted by proprietary firm, it shall be signed by the proprietor above his full name, full name of his firm with his current address.
- If the Tender is submitted by a firm in partnership, it shall be signed by a partner holding the power of Attorney for the firm. A certified copy of the Partnership deed and power of attorney shall accompany the Tender; Alternatively, it shall be signed by all the partners.

- III. If the Tender is submitted by a limited company or a limited corporation, it shall be signed by a duly authorized person holding the power of attorney for the firm. A certified copy of the power of attorney shall accompany the Tender.
- IV. If a Tender is submitted by a Joint venture/Consortium, each firm in the Joint venture/Consortium shall furnish the evidence admissible in law /Power of Attorney to sign the Form of Tender and Lead member as stated in JV Agreement shall sign the Tender documents for submission of Tender.

Any amendments such as interlineations, erasures, or overwriting shall be valid only if they are signed or initialed by the person signing the Tender

K-RIDE

D. SUBMISSION OF TENDERS

15. SEALING AND MARKING OF TENDERS

Tenderer shall submit the Tender electronically before the submission date and time published.

16. DEADLINE FOR SUBMISSION OF THE TENDERS

16.1 Tenders must be submitted online through Karnataka Public Procurement Portal to the Employer on or before the date as specified in the Karnataka Public Procurement Portal and the submission of tender is the responsibility of the Tenderer.

16.2 The Employer may extend the deadline for submission of tenders by issuing an amendment in accordance with Clause 9, in which case all rights and obligations of the Employer and the Tenderers previously subject to the original deadline will then be subject to the new deadline.

17. LATE TENDERS

17.1 In online e-procurement system, the Tenderer shall not be able to submit the Tender after the Tender submission time and date as the icon for the task in the Karnataka Public Procurement Portal will not be available. Any Tender received by the Employer after the deadline prescribed in Clause 16 will be rejected.

17.2 "It shall be the responsibility of the tenderers to ensure that their tender is submitted in the Karnataka public procurement portal within the last date and time specified for the receipt of the tenders

18. MODIFICATION AND WITHDRAWAL OF TENDERS

18.1 Tenderer may modify and correct or upload any relevant document in the portal till Tender submission date and time, as published in the Karnataka Public Procurement Portal.

18.2 No Tender may be modified after the deadline for submission of Tenders.

18.3 Withdrawal or modification of a Tender between the deadline for submission of Tenders and the expiration of the original period of Tender validity specified in Clause 12.1 above or as extended pursuant to Clause 12.2 may result in the forfeiture of the earnest money deposit pursuant to Clause 13.

18.4 DELETED

E. TENDER OPENING AND EVALUATION

19. OPENING OF FIRST COVER (Document): Opening of First Cover (Document) of all Tenders and evaluation to determine qualified Tenderers:

- 19.1 The Employer will open the First Covers (Document) of all the Tenders received (except those received late or withdrawn), including modifications for First Cover (Document) made pursuant to Clause 18, in the presence of the Tenderers or their representatives who choose to attend as per Karnataka Public Procurement Portal on the date and the place specified in Clause 16. In the event of the specified date of Tender opening being declared a holiday for the Employer, the Tenders will be opened at the appointed time and location on the next working day.
- 19.2 DELETED
- 19.3 The Tenderer name, the presence or absence of earnest money deposit (amount, format and validity), the submission of qualification information and such other information as the Employer may consider appropriate will be announced by the Employer at the opening.
- 19.4 The Employer shall prepare minutes of the Tender opening, including the information disclosed to those present in accordance with Sub-Clause 19.3.
- 19.5 DELETED
- 19.6 The Employer will evaluate and determine whether each tender (a) meets the eligibility criteria defined in ITT Clause 2 is accompanied by the required earnest money deposit as per stipulations in ITT Clause 13 and meets the minimum qualification criteria stipulated in ITT Clause 3. The Employer will draw out a list of qualified Tenderers.

20. OPENING OF SECOND COVER (DOCUMENT) OF QUALIFIED TENDERERS AND EVALUATION:

- 20.1 The Employer will inform all the Qualified Tenderers the time, date and venue fixed for the opening of the Second Cover (Document) containing the priced Tenders published Karnataka Public Procurement Portal. The Employer will open the Second Covers (Document) of Qualified Tenderers at the appointed time and date in the presence of the Tenderers or their representatives who choose to attend. In the event of the specified date of financial Tender opening being declared a holiday for the Employer, the Second Covers (Document) will be opened at the appointed time and location on the next working day.
- 20.2 DELETED
- 20.3 The Tenderers' names, the Tender prices, the total amount of each Tender, Tender modifications and withdrawals, and such other details as the Employer may consider appropriate, will be announced by the Employer at the opening. No Tender shall be rejected at Tender opening.
- 20.4 The Employer shall prepare minutes of the Second Cover (Document) Tender opening, including the information disclosed to those present in accordance with Sub-Clause 20.3.

21. PROCESS TO BE CONFIDENTIAL

- 21.1 Information relating to the examination, clarification, evaluation, and comparison of Tenders and recommendations for the award of a contract shall not be disclosed to Tenderers or any other persons not officially concerned with such process until the award to the successful Tenderer has been announced. Any effort by a Tenderer to influence the Employer's processing of Tenders or award decisions may result in the rejection of his Tender.

22. CLARIFICATION OF TENDERS

- 22.1 To assist in the examination, evaluation, and comparison of Tenders, the Employer may, at his discretion, ask any Tenderer for clarification of his Tender, including breakdowns of unit rates. The request for clarification and the response shall be in writing or by cable, but no change in the price or substance of the Tender shall be sought, offered, or permitted except as required to confirm the correction of arithmetic errors discovered by the Employer in the evaluation of the Tenders in accordance with Clause 24.
- 22.2 No Tenderer shall contact the Employer on any matter relating to its Tender from the time of the Tender opening to the time the contract is awarded.

If they have any query/clarification related to e-Procurement on the Karnataka Public Procurement Portal, contact e-Procurement Help desk from 10:00 AM to 5:00 PM. Ph. No.: +91-8046010000/ 8068948777 or support@eprochelpdesk.com Karnataka Public Procurement Portal through query option on or before specified time.

- 22.3 Any effort by the Tenderer to influence the Employer in the Employer's Tender evaluation, Tender comparison or contract award decisions may result in the rejection of the Tenderers' Tender.

23. EXAMINATION OF TENDERS AND DETERMINATION OF RESPONSIVENESS

- 23.1 Prior to the detailed evaluation of Tenders, the Employer will determine whether each Tender; (a) has been properly signed; and; (b) is substantially responsive to the requirements of the Tender documents.
- 23.2 A Substantially responsive Tender is one which conforms to all the terms, conditions, and specifications of the Tender documents, without material deviation or reservation. A material deviation or reservation is one (a) which affects in any substantial way the scope, quality, or performance of the Works; (b) which limits in any substantial way, inconsistent with the Tender documents, the Employer's rights or the Tenderer's obligations under the Contract; or (c) whose rectification would affect unfairly the competitive position of other Tenderers presenting substantially responsive Tenders.
- 23.3 If a Tender is not substantially responsive, it will be rejected by the Employer, and may not subsequently be made responsive by correction or withdrawal of the nonconforming deviation or reservation.

24. CORRECTION OF ERRORS

- 24.1 Tenders determined to be substantially responsive will be checked by the Employer for any arithmetic errors. Errors will be corrected by the Employer as follows:

- where there is a discrepancy between the amount in figures and in words, the lower of the two will govern and
- Deleted.

24.2 The amount stated in the Tender will be adjusted by the Employer in accordance with the above procedure for the correction of errors and, with the concurrence of the Tenderer, shall be considered as binding upon the Tenderer. If the Tenderer does not accept the corrected amount the Tender will be rejected, and the earnest money deposit may be forfeited in accordance with Sub-Clause 13.6 (b).

25. EVALUATION AND COMPARISON OF TENDERS

25.1 The Employer will evaluate and compare only the Tenders determined to be substantially responsive in accordance with Clause 23.

25.2 In evaluating the Tenders, the Employer will determine for each Tender the evaluated Tender Price by adjusting the Tender Price as follows:

(a) Making any correction for errors pursuant to Clause 24; and

(b) DELETED

25.3 The Employer reserves the right to accept or reject any variation, deviation, or alternative offer. Variations, deviations, and alternative offers and other factors which are in excess of the requirements of the Tender documents or otherwise result in unsolicited benefits for the Employer shall not be taken into account in Tender evaluation.

25.4 The estimated effect of the price adjustment conditions under Clause 40 of the Conditions of Contract, during the implementation of the Contract, will not be taken into account in tender Evaluation

25.5 If the tender of the successful tenderer is seriously unbalanced in relation to the Employer's estimate of the cost of the work to be performed under the contract, the Employer may require the Tenderer to produce detailed price analyses for any or all items of the Price Schedule, to demonstrate the internal consistency of those prices with the construction methods and schedule proposed. After evaluation of the price analyses, the Employer may require that the amount of the performance security set forth in Clause 29 be increased at the expense of the successful Tenderer to a level sufficient to protect the Employer against financial loss in the event of default of the successful Tenderer under the contract.

F. AWARD OF CONTRACT

26. AWARD CRITERIA

- 26.1 Subject to Clause 27, the Employer will award the Contract to the Tenderer whose Tender has been determined to be substantially responsive to the Tender documents and who has offered the lowest evaluated Tender Price, provided that such Tenderer has been determined to be (a) eligible in accordance with the provisions of Clause 2, and qualified in accordance with the provisions of Clause 3.

27. EMPLOYER'S RIGHT TO ACCEPT ANY TENDER AND TO REJECT ANY OR ALL TENDERS

- 27.1 Notwithstanding Clause 26, the Employer reserves the right to accept or reject any Tender, and to cancel the Tender process and reject all Tenders, at any time prior to the award of Contract, without thereby incurring any liability to the affected Tenderer or Tenderers or any obligation to inform the affected Tenderer or Tenderers of the grounds for the Employer's action.

28. NOTIFICATION OF AWARD AND SIGNING OF AGREEMENT

- 28.1 The Tenderer whose Tender has been accepted will be notified of the award by the Employer prior to expiration of the Tender validity period by cable, telex, e-mail or facsimile confirmed by registered letter. This letter (hereinafter and in the *Conditions of Contract* called the "Letter of Acceptance") will state the sum that the Employer will pay the Contractor in consideration of the execution, completion, and maintenance of the Works by the Contractor as prescribed by the Contract (hereinafter and in the Contract called the "Contract Price").
- 28.2 The notification of award will constitute the formation of the Contract, subject only to the furnishing of Performance Security in accordance with the provisions of Clause 29. Until a formal contract is prepared and executed, the notification of award shall constitute a binding Contract.
- 28.3 The Agreement will incorporate all agreements between the Employer and the successful Tenderer. It will be kept ready for signature of the successful Tenderer in the office of Employer within 30 days following the notification of award along with the Letter of Acceptance. Within 20 days of receipt, the successful Tenderer will sign the Agreement and deliver it to the Employer.
- 28.4 Upon the furnishing by the successful Tenderer of the Performance Security, the Employer will promptly notify the other Tenderers that their Tenders have been unsuccessful.
- 29.5 The Cost of stamp duty of the contract agreement shall be borne by the contractor as per the Karnataka Stamp Duty Act.

29. PERFORMANCE SECURITY

- 29.1 Within 20 days of receipt of the Letter of Acceptance, the successful Tenderer shall deliver to the Employer a Performance Security in any of the forms given below for an amount equivalent to **3% of the Contract price plus additional security for unbalanced tenders (additional security at 50% of the estimated cost of the unbalanced component)** in accordance with Clause 25.5 of ITT and Clause 43 of the Conditions of Contract.

- Banker's cheque/Demand draft, /Pay Order/ BG in favor of K-RIDE, Bangalore or
- A bank guarantee in the form given in Section 10; or
- Specified Small Savings Instruments pledged to K-RIDE, Bangalore.
- Specified small savings instruments in the form of "Fixed Deposits (without any encumbrances)" in the name of K-RIDE

29.2 If the Performance Security deposit is provided by the successful tenderer in the form of Bank Guarantee, it shall be issued either by a Nationalized / Scheduled bank.

29.3 The Performance Security deposit if furnished in cash or demand draft can, if requested, be converted to interest bearing securities at the cost of the contractor.

29.4 Failure of the successful tenderer to comply with the requirements of sub-clause 29.1 and clause 29 of additional ITT, shall constitute sufficient grounds for cancellation of the Tender award and forfeiture of the Earnest money deposit.

30. ADVANCE PAYMENT AND SECURITY:

30.1 The Employer will provide an advance payment on the contract price as stipulated In the condition of contract subject to the maximum as stated In the contract data.

31. CORRUPT OR FRAUDULENT PRACTICES

31.1 "corrupt practice" means the offering, giving, receiving or soliciting of anything of value to influence the action of the public official in the procurement process or in contract execution;

"Fraudulent practice" means a misrepresentation of facts in order to influence a procurement process or the execution of a contract to the detriment of the Procurement Entity, and includes collusive practice among the tenderers either prior to or after tender submission, designed to establish tender prices at artificial non-competitive levels and to deprive the Procurement Entity of the benefits of free and open competition;". The debarment action shall be taken as per KTPP Act.

31.2 The K-RIDE requires that the Tenderers/Suppliers/Contractors, observe the highest standard of ethics during the procurement and execution of such contracts. In pursuance of this policy, K-RIDE:

- a) will reject a proposal for award if it determines that the Tenderer recommended for award has engaged in corrupt or fraudulent practices in competing for the contract in question;
- b) will declare a firm ineligible, either indefinitely or for a stated period of time, to be awarded a K-RIDE contract if it at any time determines that the firm has engaged in corrupt or fraudulent practices in competing for, or in executing, a K-RIDE contract.

31.3 Furthermore, Tenderers shall be aware of the provision stated in sub-clause 50.2 of the Conditions of Contract.

32. PURCHASE PREFERENCE TO MAKE IN INDIA:

The provisions of revised 'Public Procurement (Preference to Make in India) Order 2017' issued by Department of Industrial Policy and Promotion under Ministry of Commerce and Industry vide letter no. P-45021/2/2017-PP (BE-II) dated 28.05.2018 shall be applicable to the tendering process and award of the contract shall be done accordingly. In this connection, the minimum local content shall be 50% and the margin of purchase preference shall be 20%. For award of contract, para 3.c. of the revised 'Public Procurement (Preference to Make in India) Order 2017' shall be applicable in addition to the other provisions in the tendering documents in this regard.

33. APPEAL:

The Tenderer shall submit online appeal within 30 days period from the date of receipt of order to the Employer through the Karnataka Public Procurement Portal. The Employer may after giving opportunity to the parties pass such order as it deems fit and such order shall be final.

K-RIDE

ADDITIONAL INSTRUCTIONS TO TENDERERS
(THIS SHOULD BE READ IN CONTINUATION OF ITT)

ITT Clause Ref.	Description
2.3	<p>The following paras are added:</p> <p>Wherever the word JV is mentioned, it should be read as JV/Consortium.</p> <p>For any purpose herein, 'Joint Venture' means an ad hoc association of firms that pool their resources and skills to undertake a large or complex contract in the role of "Contractor," with all firms (partners in the JV) being legally liable, jointly and severally, for the execution of the Contract in the event of a partner's withdrawal.</p> <p>A Tenderer may be a natural person, private entity, government-owned entity, or any combination of them with a format intent to enter into an agreement or under an existing agreement in the form of a Joint venture or consortium. The Tenderer must ensure the following</p> <p>(a) In case of Single Entity:</p> <p style="padding-left: 20px;">(i) Submit Power of Attorney authorizing the signatory of the Tender to commit the Tenderer.</p> <p>(b) In case of Joint Venture/ Consortium:</p> <p style="padding-left: 20px;">(i) The number of partners in the JV/ Consortium shall not be more than three.</p> <p style="padding-left: 20px;">(ii) At the time of bidding, the tenderer (JV) to submit the JV Agreement, as per the form given in Section 3: Qualification and Information/Bidding Forms. On issue of LOA, the JV/Consortium Agreement should be registered and shall be submitted along with the performance security.</p> <p style="padding-left: 20px;">(iii) The JV/ Consortium shall nominate a Representative through Power of Attorney (Form given in Section 3) who shall have the authority to conduct all business for and on behalf of any and all the parties of the JV/ Consortium during the Tendering process and, in the event the JV/ Consortium is awarded the Contract, during contract execution.</p> <p style="padding-left: 20px;">(iv) Submit Power of Attorney by individual partners to lead partners as per the form given in Section 3.</p> <p style="padding-left: 20px;">(v) In case a Joint Venture/ Consortium is the successful Tenderer, the appropriate Joint Venture/ Consortium Agreement for execution of work should be entered by the Joint Venture/ Consortium partners. The duly signed Joint Venture/ Consortium Agreement should be submitted along with the tender submission.</p> <p style="padding-left: 20px;">(vi) The lead member as aforesaid shall be authorized to incur liabilities and receive instructions for and on behalf of any and all the partners of the Joint venture/Consortium and the entire execution of the contract.</p> <p style="padding-left: 20px;">(vii) All members of the Joint venture/Consortium shall be Jointly and severally responsible for the execution of the Contract.</p> <p style="padding-left: 20px;">(viii) Change in constitution or percentage participation of JV/Consortium shall not be permitted at any stage after submission of Tenders</p> <p>(c) Only firms that are registered or incorporated in India are eligible to compete. Any Tenderer from a country which shares a land with India will be eligible to Tender in this tender only if the Tenderer is registered with the Competent Authority.</p>

(d) "Tenderer from a country which share a land border with India" for the purpose of this Order means: -

1. An entity incorporated, established or registered in such a country; or
2. A subsidiary of an entity incorporated, established or registered in such a country; or
3. An entity substantially controlled through entities incorporated, established or registered in such a country; or
4. An entity whose beneficial owner is situated in such a country; or
5. An Indian (or other) agent of such an entity; or
6. A natural person who is a citizen of such a country; or,
7. A consortium or joint venture where any member of the consortium or joint venture falls under any of the above

(e) The beneficial owner for the purpose of above clause will be as under:

- (i) In case of a company or Limited Liability Partnership, the beneficial owner is the natural person(s), who, whether acting alone or together, or through one or more juridical person(s), has a controlling ownership interest or who exercises control through other means.

Explanation-

- a. "Controlling ownership interest" means ownership of or entitlement to more than twenty-five percent of share or capital or profits of the company;
 - b. "Control" shall include the right to appoint majority of the directors or to control the management or policy decisions including by virtue their shareholding or management rights or shareholders agreements or voting agreements;
- (ii) In case of a partnership firm, the beneficial owner is the natural person(s) who, whether acting alone or together, or through one or more juridical person, has ownership of entitlement to more than fifteen percent of capital or profits of the partnership;
- (iii) In case of an unincorporated association or body of individuals, the beneficial owner is the natural person(s), who, whether acting alone or together, or through one or more juridical person, has ownership of or entitlement to more than fifteen percent of the property or capital or profit of such association or body of individuals;
- (iv) Where no natural person is identified under (i) or (ii) or (iii) above, the beneficial owner is the relevant natural person who holds the position of senior managing official;
- (v) In case of a trust, the identification of beneficial owner(s) shall include identification of the author of the trust, the trustee, the beneficiaries with fifteen percent or more interest in the trust and any other natural person exercising ultimate effective control over the trust through a chain of control or ownership.

2.4

The Tenderer shall submit a Certificate stating that they have read the above clause using the appropriate Performa given in Section 3 - Form 3C1 & 3C2.

Tenderer having a conflict of interest shall be disqualified. The conflict of interest is detailed below.

A Tenderer or any of its constituents shall not have conflict of interest. All Tenderers found to have a conflict of interest shall be disqualified. A Tenderer may be considered to be in a conflict of interest with one or more parties in this Tendering process, if, including but not limited to::

- (a) they have controlling shareholders in common; or
- (b) they receive or have received any direct or indirect subsidy from any of them; or
- (c) they have the same legal representative for purposes of this Tender; or
- (d) they have a relationship with each other, directly or through common third parties, that puts them in a position to have access to information about or influence on the Tender of another Tenderer, or
- (e) any firm, either individually or in Joint Venture (JV)/ Consortium, submits more than one offer irrespective of whether the firm is quoting against this Tender. The Tenders submitted by two different Tenderers, having any common participant in JV/ Consortium formation or any common partner in partnership firms, or an individual will be treated as having conflict of interest or
- (f) a Tenderer who is Sub-contractor to another Tenderer will be treated as having conflict of interest. However, this does not limit the inclusion of the same sub-contractor in more than one Tender.
- (g) a Tenderer participated as a consultant in the preparation of the design or specifications of the contract that is the subject of the Tender; or
- (h) A Tenderer was affiliated for any period(s) during last two years before the date of issue of Invitation for Tenders with a firm or entity that has been hired (or is proposed to be hired) by the Employer as Engineer for the contract.

2.5

The Tenderer shall be disqualified if:

- (a) The Tenderer or any of its constituents has been blacklisted/ banned from business dealings with all Government Departments by the Government of Karnataka or by Ministry of Railways or by K-RIDE at any time till finalization of Tenders, except in cases where such blacklisting/ banning has been withdrawn by Competent Authority or has ceased or expired on the deadline for submission of the Tenders, for which satisfactory evidence is to be produced.
- (b) Any previous contract of the Tenderer or any of its constituents had been fully terminated or part terminated for its failure as a JV/ Consortium partner with forfeiture of its full Performance Security, by Rail Infrastructure Development Company (Karnataka) Ltd.(K-RIDE) at any time starting from 3 years before the deadline for submission of Tenders and up to one day before the date of opening of price Tenders;

Provided, however, there is no stay order or declaration by any Court against such termination of the contract by Rail Infrastructure Development Company (Karnataka) Ltd. or such termination of the contract has not been revoked by Rail Infrastructure Development Company (Karnataka) Ltd or competent authority of K-RIDE has not passed an order of non-applicability of disqualification of the Tenderer or any of its constituents despite such termination.

- (c) The Tenderer or any of its constituents has been imposed delay damages of 5% or more of contract value by K-RIDE due to delay in the implementation of any previous contract within the period of last 2 years before the deadline for submission of Tenders (Period of 2 years shall be reckoned from the date on which the total accrued amount of Delay Damages has reached 5% or more of the contract price) or such accrued delay damages has not been fully recovered before the deadline for submission of Tenders on account of contractor's request for deferring recovery to maintain cash flow and K-RIDE has acceded to the same in the interest of the project or the work under the previous

	<p>contract in question has not been completed before the deadline for submission of Tenders, unless imposition of such delay damages has been set aside by the Competent Authority.</p> <p>(d) The Tenderer or any of its constituents:</p> <p>(i) has suffered bankruptcy/insolvency or</p> <p>(ii) has any ongoing case of insolvency before the NCLT/ any applicable Court where Interim Resolution Professional (IRP) has been appointed or is at any later stage of the insolvency process, as on the deadline of submission of Tenders or thereafter till finalization of Tenders.</p> <p>(e) The Tenderer is found ineligible by the Employer, in accordance with ITB-3.</p> <p>(f) The Tenderer or its constituent(s) has been declared by K-RIDE to be a poor performer and the period of poor performance is still in force on the deadline for submission of Tenders.</p> <p style="text-align: center;">OR</p> <p>The Tenderer or its constituent(s) has been declared by K-RIDE to be a poor performer at any time after the deadline for submission of Tenders and upto one day before the date of opening of price Tenders.</p> <p>(g) The Tenderer or any of its constituents has changed its name or created a new business entity as covered by the definition of "Allied Firm" under para 1102 (iii) of Chapter XI of Vigilance Manual of Indian Railways (available on website of Indian Railways), consequent to having been banned from business dealings or suspended from business dealings or having been declared poor performer.</p> <p>The Tenderer shall submit an affidavit stating that they are not liable to be disqualified as per this sub clause using the Form PS3 given in Section-3: Qualification and Information/Bidding Forms. Non-submission of an affidavit by the Tenderer shall result in summary rejection of his Tender.</p> <p>Tenderers shall immediately inform the Employer in case they cease to fulfil eligibility in terms of ITT clause 2 above. In case the Tenderer fails to inform the Employer or submits a false affidavit, his Tender shall be summarily rejected and Tender security shall be forfeited. The Tenderer shall also be liable for Banning of Business dealings for a period up to five years</p>
2.6	<p>PARTNERS IN CASE OF JV/CONSORTIUM</p> <p>(i) Lead partner must have a minimum of 50% participation in the JV/Consortium.</p> <p>(ii) Partners having 25% or more percentage participation shall be termed as substantial partner/other Partners.</p> <p>(iii) In case of JV/Consortium, change in constitution or percentage participation shall not be permitted at any stage after the bid submission.</p> <p>The bidder, in case of JV/Consortium, shall clearly and unambiguously define the role and responsibilities for each partner in the JV agreement submitted as per Form JV/4 of Section-3, providing clearly that any abrogation/subsequent re-assignment of any responsibility by any partner of JV/Consortium in favor of other JV/Consortium partner or any change in constitution of partners of JV/Consortium (without written approval of Client) from the one given in JV agreement at tender stage, will be treated, as 'breach of contract condition' and/or 'concealment of facts' as the case may be and acted accordingly. All Members of the JV/ Consortium must have experience in execution of similar work.</p>

2.7	<p>In addition to the documents asked Following needs to be submitted by the bidders;</p> <p>(a) Affidavit in case of Proprietary firm. (b) Partnership Deed in case of partnership firm. (c) Memorandum & Article of Association in case of Public/Private limited company. (d) Authorization/POA in favour of authorised signatory of bidder to sign the bid. (e) Board of Resolution nominating particular director to authorize a signatory to sign the bid. (f) In case of JV partners, the above relevant documents as applicable needs to be submitted.</p>
3.3(a)	<p>The following para is added:</p> <p>Materials, Equipment and Services</p> <p>The materials, equipment and services to be supplied under the Contract shall be from the approved sources as specified in Section 8A: Works Requirements and Price Schedule Section-9.</p>
7.3	<p>The following para is added:</p> <p>The Employer is not responsible for the completeness of the Bidding Document and their Addenda, if they were not obtained directly from the source stated by the Employer in the Invitation for Bids.</p> <p>The Bidder is expected to examine all instructions, forms, terms, and specifications in the Bidding Document. Failure to furnish all information or documentation required by the Bidding Document may result in the rejection of the bid.</p>
8.3	<p>The following para is added:</p> <p>The Pre-Tender meeting may also be attended through video conferencing (VC). Those Tenderers who wish to join the Video Conferencing shall send a request email on the email id (i.e. electrical.kride@gmail.com) by 17/02/2023 up to 11:30 hours IST, so that a link for Video Conferencing can be sent by K-RIDE.</p> <p>Please note that the request received from the Tenderers (With details of the Company, its address, and the name and designation of the person attending the VC) will only be entertained. They should also mention the email id through which VC is desired to be joined.</p> <p>K-RIDE may allow maximum of two email Ids for one company to participate in the VC. Any request for VC received after the given date and time for sending the link for VC will not be entertained.</p> <p>Prospective Tenderers will be able to join the VC through the link provided to them on Email ID. During this pre- Proposal meeting, prospective Tenderers may request for clarifications.</p>
10.3	<p>The following para is added:</p> <p>Documents Comprising the Tender</p> <ul style="list-style-type: none"> • The Tender shall comprise of Tender Security/Tender Security Declaration, Technical Tender and Price Tender. The Tenderer shall submit the Tender through Karnataka Public Procurement Portal. • On the stipulated date of opening of Tenders, initially, only the Technical Tenders are opened through Karnataka Public Procurement Portal. The Technical Tenders shall be evaluated by the Employer in accordance with the stipulated Qualification and Evaluation criteria. No amendments or changes to the Technical Tenders would be permitted after the opening of technical Tenders. • Tenderers who are qualified in the technical evaluation their price Tender shall be opened at a date and time advised by the Employer (K-RIDE) through e-tendering portal. The Price Tenders are

evaluated and the Contract is awarded to the Tenderer whose Tender has been determined to be the lowest evaluated substantially responsive Tender.

The Technical Tender shall contain the following:

- All the Forms of Section-3: Qualification Information/Bidding Forms including letter of technical Bid (LTB) shall be scanned and uploaded.
- The Tenderer shall furnish a commitment in Letter of Technical Bid (LTB) for deployment of equipment and personnel as stipulated in Section 8A: Employers Work's Requirement.
- The Tenderer shall furnish commitment in LTB for submitting construction method statement for all major activities of work and get this approved from the engineer prior to the commencement of work on that activity in case of award of contract.
- The Tenderer shall furnish a commitment in Letter of Technical Bid (LTB) for adhering to mobilisation and construction schedule as stipulated in Section 8A: Employers Work's Requirement.
- **Tenderer should note that non-submission of the Letter of Technical Bid (LTB) by the Tenderer shall result in summary rejection of his Tender.**
- Tenderer shall submit the Approach and Methodology for performing the assignment by using appropriate Performa given in Section 3: Qualification Information/Bidding Forms.
- Scanned copy of Tender Security/Tender Security Declaration form (Section 3), in accordance with ITT Clause 13;
- Scanned copy of written confirmation authorizing the signatory of the Tender to commit the Tenderer, any amendments such as interlineations, erasures, or overwriting shall be valid only if they are signed or initialed by the person signing the Tender.
- Scanned copy of documentary evidence with establishing the Tenderer's qualifications to perform the contract; To establish its qualifications to perform the Contract in accordance with Section 2: ITT the Tenderer shall submit as part of its technical Tender the information requested in the corresponding information sheets included in Section 3: Qualification Information/Bidding Forms.

Domestic Tenderers, individually or in joint ventures, applying for eligibility for domestic preference shall supply all information required to satisfy the criteria for eligibility

- Scanned copy of Approach and Methodology - Performa given in Section-3: Qualification Information/Bidding Forms
- Scanned copy of Joint Venture Agreement entered into by all partners

The Price Tender shall contain the following:

- Scanned copy of Letter of Price Tender.
- All Section-3 Documents shall be scanned and submitted.

	<ul style="list-style-type: none"> • Filled/completed schedules as required including Price Schedule in accordance with ITT Clauses should be submitted through Karnataka Public Procurement Portal only; • The Tenderer shall submit through Karnataka Public Procurement Portal, separate Technical Proposal and Price Proposal for each individual contract package, using the appropriate Submission Sheets furnished in Section-3: Qualification Information/Bidding Forms. These Forms must be completed without any alterations to their format, and no substitutes shall be accepted. All blank spaces shall be filled in with the information requested. • The Tenderer shall submit, as part of the Price Tender, the Schedules, including the Price Schedule through Karnataka Public Procurement Portal only.
11.5	<p>The following para is added:</p> <p>Tender Prices</p> <ul style="list-style-type: none"> • The prices quoted by the Tenderer in the Price Schedule shall conform to the requirements specified below. • In the price schedule, the tenderer shall quote rates as single percentage/Amount Above/Below/At par as per the format for each schedule. The price quoted by the bidder in schedule will only be considered for evaluation of bids. Rates offered through any other medium or at any other location will not be considered. If any Tenderer quotes more than one percentage/amount for such schedules, its Tender shall be summarily rejected. • The Tenderer shall fill in percentage for all items of the Works described in the Price schedule. Items against which no rate or price is entered by the Tenderer will not be paid for by the Employer when executed and shall be deemed covered by the rates for other items and prices in the price schedule • The price to be quoted in the Price Schedule, in accordance with ITT, shall be the total price of the Tender. • DELETED • DELETED • Unless otherwise provided in the ITT and the Contract, the Rates quoted by the Tenderer are subject to adjustment during the performance of the Contract in accordance with the provisions of the Conditions of Contract. In such a case, the indices and weightages for the price adjustment formulae shall be as specified in the Tables of Adjustment Data included in Contract Data. • DELETED • All duties, taxes including GST, royalties, cess and other levies payable by the Contractor under the Contract, or for any other cause (including standard specifications), as of the date 28 days prior to the deadline for submission of Tenders, shall be included in the percentage quoted in the Price Schedule and the total Tender Price submitted by the Tenderer. GST shall be paid by the Tenderer as applicable in accordance with the prevailing rules of Government of India • Tenderers should note that during the progress of the works, the foreign currency requirements of the outstanding balance of the Contract Price may be adjusted by agreement between the

	<p>Employer and the Contractor in order to reflect any changes in foreign currency requirements for the Contract, in accordance with Sub-Clause 14/ITT (Currencies of Bid and Payment) of the Conditions of Contract. Any such adjustment shall be affected by comparing the percentages quoted in the Tender with the amounts already used in the Works and the Contractor's future needs for imported items.</p> <ul style="list-style-type: none"> • Tenderer should note that non-submission of the Letter of Price Tender (LPB) by the Tenderer shall result in summary rejection of his Tender. • Online alternative Price Tender corresponding to the alternative Technical Tender, if permissible, in accordance with ITT Clause 14;
13.7	<p>The following para is added:</p> <p>In this tender, the tender security/ EMD has to be paid.</p> <p>The firm can choose either of the way for EMD payment. Full EMD as e-payment The Technical bids along with the Earnest Money Deposit (EMD) i.e.,15,00,000/- can be paid through e-payment as specified in sub clause 10.1.1 and 13.7 of Section. 2 of ITT in the e-procurement portal only using any of the following Five modes:</p> <p>Online Modes</p> <ul style="list-style-type: none"> • Credit Card. • Direct Debit. • Net Banking <p>Offline Modes</p> <ul style="list-style-type: none"> • National Electronic Fund Transfer (NEFT). • Over the Counter (OTC) <p>The EMD amount of Rs.15,00,000/- accepted in the form of online and offline modes as mentioned above. For online mode bidder has to pay the EMD through one of the three modes (credit card, debit card & Net banking) mentioned above.</p> <p>For offline payment modes bidder has to pay the EMD through National Electronic Fund Transfer (NEFT) or Over the Counter (OTC). For offline NEFT and OTC mode bidder has to complete the payment as per the user manual given in E-proc portal and enter the bank transaction reference number on the E-Proc portal to complete the procedure.</p> <p>For further details, kindly Click on the https://eproc.karnataka.gov.in/eprocportal/pages/contractors.jsp Then click on User Manuals & Refer e-payments.</p> <p style="text-align: center;"><u>OR</u></p> <p>In this tender, the tender security/ EMD has to be paid.</p> <p>The Technical bids along with the Earnest Money Deposit (EMD) i.e., Rs.15,00,000/- should be paid through e-payment as specified in sub clause 10.1.1 and 13.7 of Section. 2 of ITT in the e-procurement portal only using any of the following four modes:</p> <ul style="list-style-type: none"> • Credit Card. • Direct Debit. • National Electronic Fund Transfer (NEFT). • Over the Counter (OTC).

The part of the EMD amount of Rs.1.00 lakh accepted in the form of electronic cash (not through DD/BG) and will be maintained in the Government of Karnataka central pooling account held at ICICI Bank until the contract is closed.

The balance required EMD of Rs.14,00,000/- to be furnished in the form of Bank Guarantee (BG) of any Nationalized Bank/Scheduled Bank (as per RBI guidelines) payable to –Managing Director/K-RIDE, Bengaluru. The EMD shall have to be valid for 45 days beyond the validity of the tender. The scanned copy of the BG should be uploaded to the tender in the e-procurement platform. The Original Bank Guarantee shall compulsorily be produced & submitted for verification before opening of the Technical bid date and time as specified in e-portal to the JGM/Elec in K-RIDE office. The bidder shall note that the Original Bank Guarantee submitted through post/in person, if it does not reach on or before the date of opening of the tender as specified in e-portal to the JGM/Elec in K-RIDE office the bid will not be considered for technical evaluation. The bids of the contractors who have failed to produce and submit the original bank guarantee of earnest money deposit of tender on or before the date of opening of the tender as specified in e-portal to the JGM/Elec, the bids will not be opened. If it is opened by default/manual/electronic error the bid will not be considered for technical evaluation and bid shall be rejected. Non reconciliation of tender earnest money deposit receipt of payment in Government of Karnataka central pooling account held at the ICICI Bank, the tender gets rejected.

- Bank Guarantee Format

An unconditional bank guarantee using the Form given in Section 3: Qualification Information and Bidding Forms. The bank guarantee shall be from a bank having minimum net worth of over INR 500 million from the specified banks as under:

- (i) a Scheduled Bank in India, or
- (ii) a Foreign Bank having their operations in India, or
- (iii) a Foreign Bank which do not have operations in India is required to provide a counter-guarantee by State Bank of India,

The Scheduled Bank issuing the Bank Guarantee must be on “Structure Financial Messaging System (SFMS)” platform. A separate advice of the BG shall be invariably be sent by the issuing bank to the Employer’s Bank through SFMS and only after this the BG shall become operative and acceptable to the Employer.

Further, the Tender Security in Original form along with a copy of “MT760COV (in case of Bank Guarantee message) / MT767COV (in case of Bank Guarantee amendment message) Report” sent by the BG issuing Bank Sealed in an envelope shall be submitted, as stated in ITT 15.

The Issuing Bank shall send the SFMS to:

Beneficiary: Rail Infrastructure Development Company (Karnataka) Limited (K-RIDE)

Bank Name: Canara Bank

Branch: Prime Corporate Branch

Account No. 0430201012110

IFSC Code: CNRB0002636

The Tender security shall be valid up to 45 days beyond tender validity, or up to the date mentioned in the letter of request for extension, if any under ITT 12.

In case the Tenderer has opted for Tender security in the form of an unconditional Bank Guarantee, the Tenderer should upload the scanned copy of Bank Guarantee with the Tender. Non-submission of scanned copy of Bank Guarantee with the Tender on e-tendering portal and non-submission of original

	<p>Bank Guarantee within the specified period shall lead to summary rejection of Tender. The details of the BG, physically submitted should match with the details available in the uploaded scanned copy and the data entered during Tender submission time, failing which the Tender will be rejected.</p> <p>Unless otherwise specified in the BDS, any Tender not accompanied by an enforceable and compliant Tender security as required in accordance with ITT, shall be summarily rejected by the Employer as non-responsive.</p> <p>The Tender security of the Tenderer who have been determined to be unqualified for opening of their financial Tender shall be returned within 3 working days after the opening of financial Tender. The Tender security of unsuccessful Tenderers shall be returned within 7 working days after issue of LOA to the successful Tenderer.</p> <p>The Tender security of the unsuccessful Tenderer shall be returned as promptly as possible once the successful Tenderer has signed the Contract and furnished the required performance security.</p> <p>The Tender security may be forfeited:</p> <ol style="list-style-type: none"> a. if a Tenderer withdraws its Tender during the period of Tender validity specified by the Tenderer on the Letter of Tenders, except as provided in ITT Clause 12 or b. if a Tenderer misrepresents or omits the facts in order to influence the procurement process; c. if the successful Tenderer fails to: <ol style="list-style-type: none"> i. sign the Contract in accordance with ITT Clause 28; ii. furnish a performance security in accordance with ITT 29; iii. accept the correction of its Tender Price pursuant to ITT 24; or iv. furnish a domestic preference security if so required. d. if the undertaking of the affidavit submitted by the Tenderer or its constituents in pursuance to ITT clause 2 or any of the declarations of Letter of Technical Tender or Letter of Price Tender submitted by the Tenderer has been found to be false at any stage during the process of Tender evaluation. <p>The Tender Security of a JV shall be in the name of the JV that submits the Tender or the lead member of the JV. If the JV has not been legally constituted at the time of Tendering, the Tender Security shall be in the names of all future partners as named in the letter of intent/ of JV mentioned in ITT Clause 2)</p>
14	<p>The following para is added:</p> <p>The Tender, as well as all correspondence and documents relating to the Tender exchanged by the Tenderer and the Employer, shall be written in English. Supporting documents and printed literature that are part of the Tender may be in another language provided they are accompanied by an accurate translation of the relevant passages in English in which case, for purposes of interpretation of the Tender, such translation shall govern</p>
15	<p>The following para is added:</p> <p>Sealing and Marking of Tenders</p> <p>The Tenderer shall submit the technical Tender, Price Tender and the Tender Security/Tender Security Declaration through Karnataka Public Procurement Portal i.e., https://eproc.karnataka.gov.in. The original of the Technical Proposal, which will contain all Forms of Section 3 except Price Schedule Section 9 and all other relevant data specified in the Tender document.</p>

	<p>The Price Bid, shall be submitted through Karnataka Public Procurement Portal only. This "PRICE BID" will contain only Price Schedule and all other relevant data specified in this Tender document. All forms should be typed on the Tenderer's' letter head as per the exact format of the Forms.</p> <p>The above forms should be scanned and submitted through Karnataka Public Procurement Portal.</p> <p>No details about price proposal shall be disclosed directly or indirectly in the technical proposal failing which the Tender shall be rejected. Only Electronic Tender submission and opening procedure permitted.</p>
19.7	<p>The following para is added:</p> <p>Tender Opening</p> <ul style="list-style-type: none"> • The Employer shall conduct the opening of Technical Tenders through Karnataka Public Procurement Portal i.e., https://eproc.karnataka.gov.in on the date and at the time mentioned. • The date and time of the opening of Price Tenders will be announced through Karnataka Public Procurement Portal • At the end of the evaluation of the Technical Tenders, the Employer will intimate Tenderers who have submitted substantially responsive technical proposals and who have been determined as being qualified for award to attend the opening of the price Proposals. The date and time, of the opening of Price Tenders will be advised through email/e-procurement. Tenderers shall be given reasonable notice for the opening of Price Tenders. • The Employer will notify Tenderers in writing who have been rejected on the grounds of being substantially non-responsive to the requirements of the Tendering Document and who have been determined as being not qualified as a result of evaluation of technical proposal and their Price Tender shall not be opened. The Tender security of the Tenderers shall be returned as per due process. • The Employer shall conduct the opening of Price Tenders through Karnataka Public Procurement Portal i.e., https://eproc.karnataka.gov.in of all Tenderers who have submitted substantially responsive Technical Tenders and who have been determined qualified as a result of technical evaluation.
23.4	<p>The following para is added:</p> <p>Deviations, Reservations, and Omissions</p> <p>During the evaluation of Tenders, the following definitions apply:</p> <ol style="list-style-type: none"> (a) "Deviation" is a departure from the requirements specified in the Tendering Document; (b) "Reservation" is the setting of limiting conditions or withholding from complete acceptance of the requirements specified in the Tendering Document; and (c) "Omission" is the failure to submit part or all of the information or documentation required in the Tendering Document.
24.3	<p>The following para is added:</p> <p>Nonconformities, Errors, and Omissions</p> <ul style="list-style-type: none"> • Provided that a Tender is substantially responsive, the Employer may waive any nonconformities in the Tender that do not constitute a material deviation, reservation or omission.

	<ul style="list-style-type: none"> • Provided that a Tender is substantially responsive, the Employer may request the Tenderer to submit the necessary information or documentation, within a reasonable period of time, to rectify nonmaterial nonconformities in the Tender related to documentation requirements. Requesting information or documentation on such nonconformities shall not be related to any aspect of the price of the Tender. Failure of the Tenderer to comply with the request may result in the rejection of its Tender.
24.4	<p>The following para is added:</p> <p>Correction of Arithmetical Errors and Omissions in Tender and Evaluation of Tender Price</p> <ol style="list-style-type: none"> 1. Provided that the Tender is substantially responsive, the Employer shall correct arithmetical errors and omissions in the Tender and then arrive at the Evaluated Tender Price on the following basis: <ol style="list-style-type: none"> (a) DELETED (b) if the percentage rate has been quoted both in words and in figures and there is a discrepancy in such rates, then the lower of the two shall prevail and shall be considered for evaluation of the price of the schedule/bill; (c) If the percentage rate has been quoted either in words or in figures only, then the same shall be considered for evaluation of the price of the schedule/bill; (d) If no percentage rate has been indicated for any particular schedule/bill in words, as well as in figures, irrespective of the fact whether the Tenderer has written or not written above/below/at par, in such cases, the rate shall be considered as Zero and the price shall be calculated accordingly; (e) if there is an error in a total corresponding to the addition or subtraction of subtotals, the subtotals shall prevail and the total shall be corrected. (f) DELETED 2. If the Tenderer has submitted the lowest evaluated Tender does not accept the correction of errors and omissions as per above provisions, its Tender shall be disqualified and its Tender security shall be forfeited or its Tender-Securing Declaration executed.
25.6	<p>The following para is added:</p> <p>Conversion to Single Currency</p> <p>For evaluation and comparison purposes the currencies of the Tender shall be converted into Indian Rupees as stated in BDS.</p> <p>An Abnormally Low Tender is one in which the Tender price, in combination with other elements of the Tender, appears so low that it raises material concerns as to the capability of the Tenderer to perform the contract at the offered price. The Employer may in such cases seek written clarifications from the Tenderer, including detailed price analysis of its Tender price in relation to scope, schedule, allocation of risks and responsibilities, and any other requirements of the Tender document. If, after evaluating the price analyses, the Employer determines that the Tenderer has substantially failed to demonstrate its capability to deliver the contract at the offered price, the Employer may reject the Tender/ proposal.</p> <p>Additional Performance Security in case of abnormally low Tenders will have to be submitted.</p> <p>The calculation sheet is as below:</p> <p>If the bid, which results in the lowest Evaluated Bid Price is substantially on lower side and/or seriously unbalanced in the opinion of the Employer as per criteria defined below, the Employer may require the bidder to submit additional performance security as under:-</p>

	<p>a) If overall price quoted by the L1 bidder is below the engineer's estimated price by more than 10% and the difference between overall price quoted by the L1 and L2 is more than 5% of the estimated price, then the bid price of L1 bidder shall be treated as substantially on lower side and such bidder shall be bound to furnish additional performance security equal to the $(0.9 \times \text{engineer's estimated price} - \text{L1 price})$ or $(0.95 \times \text{L2 price} - \text{L1 price})$ whichever is lower, on this account. Example below demonstrates the method of calculation to arrive at additional performance security:</p> <p>Suppose overall price quoted by the L1 bidder is 17% below the estimated price and the overall price quoted by L2 bidder is 8% below the estimated price. In this case the overall price quoted by the L1 bidder is lower by more than 10% of the estimated price and also the difference between overall price quoted by the L2 and L1 bidder is more than 5% of the estimated price, hence the L1 bidder shall be required to furnish additional performance security for an amount equal to $\{0.9 \times \text{engineer's estimated price} - (1 - 17/100) \times \text{engineer's estimated price}\} = \{0.07 \times \text{engineer's estimated price}\} = 7\%$ of engineer's estimated price or $\{0.95 \times (1 - 8/100) \times \text{engineer's estimated price} - (1 - 17/100) \times \text{engineer's estimated price}\} = \{0.044 \times \text{engineer's estimated price}\} = 4.4\%$ of engineer's estimated price; whichever is lower.</p> <p>As per the above L1 bidder shall be required to submit additional performance security of 4.4% of engineer's estimated price.</p> <p>b) If for any bill/ schedule of quantities % age above or below quoted by the bidder on the estimated price is beyond 15% below the overall % age difference between the quoted contract price and the engineers estimated price, then the price for that particular schedule shall be treated as seriously unbalanced and bidder shall be bound to furnish additional performance security for such unbalanced price. Example below demonstrates the method of calculation to arrive at unbalanced price and additional performance security:</p> <p>Suppose for the L1 bidder overall % age difference between quoted contract price and the engineers estimated price;</p> $(\text{Overall contract price} - \text{Overall estimated price}) \times 100 \div \text{overall estimated price} = + 4 \%$ <p>Maximum % age below permitted over estimated price of any bill / schedule in this case = $+4 - 15 = -11\%$</p> <p>Suppose for the L1 bidder has quoted 20% below estimated price then the pricing shall be treated as unbalanced and the bidder shall be required to furnish additional performance security for an amount equal to $(20 - 11) \%$ of the estimated price.</p>
26.2	<p>The following para is added:</p> <p>Award Criteria</p> <ul style="list-style-type: none"> • The Employer shall award the Contract to the Tenderer whose Tender is substantially responsive to the Tendering Document, provided further that the Tenderer is determined to be qualified to perform the Contract satisfactorily and whose offer has been determined to be the lowest evaluated subject to ITT below. In case of more than one Tenders are evaluated to be lowest, Contract shall be awarded to the Tenderer having higher average annual construction turnover (calculated as total certified payments received for contracts in progress or completed) in equivalent INR within the last Two financial years. • The Employer has the right to review at any time prior to award of contract that the qualification criteria as specified in Section-3: Qualification Information and Bidding Forms are still being met by the Tenderer whose offer has been determined to be the lowest evaluated Tender. A Tender shall be rejected if the qualification criteria as specified in Section-3: Qualification Information and Bidding

	Forms are no longer met by the Tenderer whose offer has been determined to be the lowest evaluated Tender. In this event the Employer shall proceed to the next lowest evaluated Tender to make a similar reassessment of that Tenderer's capabilities to perform satisfactorily.
29.5	<p>The following para is added:</p> <p>Performance Security</p> <p>The successful Tenderers shall have to submit a Performance Guarantee (PG) Within twenty (20) days from the date of issue of Letter of Acceptance (LOA). Extension of time for submission of PG beyond 20 days up to 60 days from the date of issue of LOA may be given by the authority who is competent to sign the contract agreement. However, a penal interest of 12% of per annum shall be charged for the delay beyond 20 days, i.e. From 21st day after the date of issue of LOA. Further if the 60th day happens to be declared holiday in the office of K-RIDE, submission of PG can be accepted on the next working day.</p> <p>In all other cases if the contractor fails to submit the requisite PG even after 60 days from the date of issue of LOA, the contract is liable to be terminate. In case contract is terminated K-RIDE shall be entitled to forfeit the Tender security and other dues payable against to the contract. In case the tenderer has not submitted by security on the strength of their registration as a start-up recognized by the Department of Industrial Policy and Promotion (DIPP) under Ministry of Commerce and Industry, DIPP shall be informed to this effect. The failed contractor shall be debarred from participating in re-tender for that work.</p> <p>Failure of the successful Tenderer to submit the above-mentioned Performance Security or to sign the Contract Agreement shall constitute sufficient grounds for the annulment of the award and forfeiture of the Tender security or execution of the Tender-Securing Declaration.</p> <p>The above provision shall also not apply to the furnishing of a Domestic Preference Security, if so required.</p>
New Clause-1	<p>LITIGATION HISTORY: (Please see Annexure Tendering Forms).</p> <p>The Tenderer/Tenderers should provide accurate information on any litigation or arbitration resulting from contracts completed or under its execution over the last five years as on date of submission of this tender.</p> <p>If the litigation started by the Tenderer without recourse to measures of Dispute Resolution and Arbitration as provided in the Contract or the litigation in respect of challenge of award of Arbitration by the Tenderer, will be treated as Litigation case indulged by the Tenderer for this Para of Litigation History. A consistent history of awards against the Applicant or any partner of a joint venture may result in failure of the application.</p> <p>Note: Tenderers including each of the partners of a Joint Venture, should provide information on any history of litigation or Arbitration resulting from contracts executed in the last 5 years as on date of submission of this tender. A separate sheet should be used for each partner of a Joint Venture</p>
New Clause-2	<p>Jurisdiction of Courts</p> <p>The Tendering process shall be governed by and construed in accordance with the laws of India and the Courts as indicated in Tender Data Sheet shall have exclusive jurisdiction over all the disputes/issues arising under, pursuant to and/ or in connection with the Tendering process. The Jurisdiction of Courts is Bengaluru, Karnataka</p>

SECTION-3

QUALIFICATION INFORMATION/BIDDING FORMS

INDEX

SECTION-3: QUALIFICATION INFORMATION/BIDDING FORMS

This Section contains the forms which are to be completed by the Bidder and to be submitted as part of this Bid.

Sl. No.	Description	Form Number/ Para No.	Page No.
A) Qualification Information/Bidding Forms			
1.	Legal status of Tenderer	Para No. 1.1	48
2.	Executed and Payment Received statement for 5 Years	Para No. 1.2	48
3.	Similar Work Experience	Para No. 1.3	49
4.	Quantities of Work executed in Last 5 years	Para No. 1.4	50
5.	Information on Works (Existing, Ongoing and Works for which Tenders already submitted)	Para No. 1.5	51
6.	Availability of Plant and Equipment Details	Para No. 1.6	51
7.	Reports of Financial Standing (Profit and Loss Statements)	Para No. 1.7	51
8.	Qualification and Experience of Key Personnel	Para No. 1.8	51
9.	Tenderers bankers Details	Para No. 1.9	51
10.	Evidence of access to Financial Resources	Para No. 1.10	51
11.	Proposed Subcontracting components	Para No. 1.11	52
12.	Information on Litigation History	Para No. 1.12	53
13.	Proposed Methodology and Program of construction	Para No. 1.13	54
B) Additional Qualification Information/Bidding Forms			
14.	Letter of Technical Bid	Form PS 1	55-57
15.	Letter of Price Bid	Form PS 2	58-59
16.	Format for Affidavit (along with Bid)	Form PS 3	60-63
17.	Bid Security Declaration Form	Form BDF/1	64
18.	Letter of participation from Each partner of Joint Venture (JV)/ Consortium	Form JV/Consortium/1	64-65
19.	Power of attorney for authorized signatory of Joint Venture (JV)/ Consortium partners	Form JV/Consortium/2	66
20.	Power of attorney to Lead partner of joint venture (JV)/ Consortium	Form JV/Consortium/3	67-68
21.	Draft Joint Venture Agreement	Form JV/Consortium/4	69-72
Bidder Qualification			
22.	Bidder's Information Sheet	Form ELI - 1	73-74
23.	JV/Consortium Information Sheet	Form ELI - 2	75-76
24.	Financial Situation	Form FIN - 1	77-78
25.	Annual Construction Turnover	Form FIN - 2	79
26.	Current Contract Commitment	Form FIN - 3	80
27.	Deleted	Form No 1	81
28.	Checklist for clauses pertaining to Summary Rejection of bid	Form No 2	82
29.	Format for certificate to be submitted by bidder along with the bid	Form 3 C1	83
30.	Format for certificate to be submitted by Bidder along with the bid for subcontracting	Form 3 C2	84
31.	Deleted	Form 4	
32.	Key Personnel for the work	Form 5	85
33.	Format of Curriculum Vitae (cv) for proposed key professional staff	Form 6	86
34.	Undertaking from specialist sub-contractor	Form CL-2	87
35.	Availability of Financial Resources	Form CL-3	88
36.	Evidence of Availability of Credit Line Financial Resources	Form CL-4	89
37.	Work Experience Certificate	Form EXP-1	90-91

A) QUALIFICATION INFORMATION/BIDDING FORMS

1. QUALIFICATION INFORMATION

The information to be filled in by the Tenderer hereunder will be used for purposes of computing Tender capacity as provided for in Clause 2 of the Instructions to Tenderers. This information will not be incorporated in the Contract.

1.1. Constitution or legal status of Tenderer

Place of Registration: _____ [Attach copy]

Principal place of business: _____ [Attach Copy]

1.2. Total value of construction works executed and payments received in the preceding five Financial Years. (Rs. In Crores) (attach certificate from Statutory Auditors)

2017-2018: -----

2018-2019: -----

2019-2020: -----

2020-2021: -----

2021-2022: -----

K-RIDE

1.3. **Work performed as Contractor (in the same name) on works of similar nature over during the five financial years specified in 1.2 above.**

Project Name	Name of Employer	Description of Work	Contract Number	Value of contract Rs. Cr.	Date of Issue of work order	Specified period of completion	Actual date of completion	If partner in a JV/ Consortium, specify participation in total contract amount	Remarks explaining reasons for delay in completion of work
1	2	3	4	5	6	7	8	9	10

Note:

- (1) If the qualifying work of similar nature is done by a joint venture/consortium, then Value shall be considered as per percentage participation by the member(s) in that joint venture/consortium.
- (2) Value of *similar nature of work completed shall be updated up to date of submission as per table given below:

Financial year	2017-18	2018-19	2019-20	2020-21	2021-22
Indian Currency					
Foreign Currency					

- (3) Updated value of completed work in foreign currency shall be converted to Equivalent INR, calculated using the selling exchange rate of Reserve Bank of India as on 28th day prior to the last date of submission of bids. In case publication is not available on 28th day, previous working day published exchange rate shall be considered for evaluation.

The bidder shall attach a copy of the Certificate(s) issued by the employer in support of the information being furnished in the above form, failing which the claim of the bidder shall be liable to be rejected (in case of experience as a sub-contractor, the employer shall be the owner of the Project who has engaged the main Contractor).

SEAL AND SIGNATURE

1.4. Quantities of work executed as contractor (in the same name) during the last five years.

Year	Name of Work	Name of Employer	Quantity of work performed.	Remarks (Indicate contract reference Contract No., Award Date, Completion date, Role in contract, total contract amount, JV participation proportion)
2017-18				
2018-19				
2019-20				
2020-21				
2021-22				

Note:

- 1) Copy of Certificate(s) issued by the employer in support of the information being furnished above, shall be attached with each respective form, as per detailed requirements indicated in clause 3.2 (c) of Section 2 failing which the claim of the bidder shall be liable to be rejected (in case of experience as a sub-contractor, the employer shall be the owner of the Project who has engaged the main Contractor).

SEAL AND SIGNATURE

1.5. Information on works for which Tenders have been submitted and works which are yet to be completed as on the date of this Tender.

(A) Existing commitments and on-going works:

Description of Work	Place & State	Contract No. & Date	Name and Address of Employer	Value of Contract (Rs. In Crores)	Stipulated period of completion	Value of works remaining to be completed (Rs. In Crores) (Attach certificate from Engineer in charge)	Value of the works to be executed in the next "P+3" months	Anticipated date of completion
(1)	(2)	(3)	(4)	(5)	(6)	(7)	(8)	(9)

(Where P=The completion period (in months) specified for the works)

(B) Works for which Tenders already submitted:

Description of Work	Place & State	Name and Address of Employer	Estimated value of works (Rs. In Crores)	Stipulated period of completion	Date when decision is expected	Remarks if any
(1)	(2)	(3)	(4)	(5)	(6)	(7)

1.6. The following items of equipment are considered essential for successfully carrying out the works. The Tenderer should furnish all the information listed below. (The item of the equipment required nos. and capacity should match with those specified in ITT clause 3.3(a))

Item of Equipment	Requirement			Owned and available nos/Age/Capacity/ Condition	Remarks (The details of hired/leased equipment details to be indicated)
	Nos	Capacity	Owned		

1.7. Reports on the financial standing of the tenderer, such as profit and loss statements and auditor’s reports for the last five years;

1.8. Qualification and experience of the key technical and management personnel in permanent employment with the tenderer and those that are proposed to be deployed on this contract, if awarded.

1.9. Name, address, and telephone, telex, and fax numbers of the Tenderers' bankers who may provide references if contacted by the Employer.

1.10. Evidence of access to financial resources to meet the qualification requirement specified in ITT Clause 3.3 (b): Cash in hand, Letter of Credit etc. List them and attach certificate from the Banker in the suggested format given in Section 3, Form No.CL3 & CL4.

1.11. Proposals for subcontracting components of works amounting to more than 20% of the contract price.

Item of Work	Value of Sub-Contract	Identified Sub-Contractor (Name and Address)	Experience of similar works (Attach Certificates from the respective Employers)	Remarks (Undertaking from Specialist subcontractors to be provided as per Form CL-2)

K-RIDE

- 1.13. The proposed methodology and program of construction, backed with equipment planning and deployment, duly supported with broad calculations and quality control procedures proposed to be adopted, justifying their capability of execution and completion of the work as per technical specifications within the stipulated period of completion as per milestones.

APPROACH & METHODOLOGY PROPOSED FOR PERFORMING THE ASSIGNMENT

Name of Project: “

The approach and methodology will be detailed precisely under the following topics:

- (1) Understanding of the assignment
- (2) Work Breakdown structure/ Work plan.
- (3) Composition of the Team
- (4) Organizational set up/ Construction methodology for execution of the work as outline in Section 8A
- (5) Documentation and procedures to be prepared, adopted and furnished to K-RIDE (Rail Infrastructure Company (Karnataka) Limited).
- (6) Reporting Procedure
- (7) Sourcing of Material

Note:

- i. The approach and methodology should be precise and relevant to the assignment. Include Bar charts.

B) ADDITIONAL QUALIFICATION INFORMATION/BIDDING FORMS

Form: PS1

LETTER OF TECHNICAL BID

(Seperately for each Package)
Date.....

Invitation for Bid No.:.....

To,
.....

We, the undersigned, declare that:

- (a) We have examined and have no reservations to the Bidding Documents, including Addenda issued in accordance with Instructions to Tenderer (ITT);
- (b) We offer to execute the Works in conformity with the Bidding Documents;
- (c) Our bid shall be valid for a period of 180 days from the date fixed for the bid submission deadline in accordance with the Bidding Documents, and it shall remain binding upon us and may be accepted at any time before the expiration of that period;
- (d) If our bid is accepted, we commit to obtain a performance security in accordance with the Bidding Documents;
- (e) If our bid is accepted, we commit to deploy key equipment and key personnel consistent with the requirements stipulated in Section 8A: Works Requirements.
- (f) If our bid is accepted, we commit to submit work method statements for all major activities and get these approved from the engineer prior to commencing work on such activities. We also understand that the work shall be executed as per the approved method statements and KEY DATES without any deviations and delay in completion.
- (g) We, including any subcontractors or suppliers for any part of the contract, do not have any conflict of interest in accordance with ITT clause 2.4;
- (h) We declare that we are not participating, as a Bidder or as a subcontractor, in more than one bid in this bidding process in accordance with ITT clause 2.2, other than alternative offers submitted in accordance with ITT clause 14;
- (i) We declare that we are not liable to be disqualified in Accordance with ITT clause 2.5, and we are enclosing the affidavit for the same as per the Performa given in the bid document.

- (j) We understand that this bid, together with your written acceptance thereof included in your notification of award, shall constitute a binding contract between us, until a formal contract is prepared and executed; and
- (k) We have not made any deviations from the requirement of the bidding document and we have also not made any tampering or changes in the bidding documents on which the bid is being submitted and if any tampering or changes are detected at any stage, we understand the bid will invite summary rejection and invocation of bid security declaration, the contract will be liable to be terminated along with forfeiture of performance security, even if LOA has been issued.
- (l) We understand that we will be considered for participating for which we have submitted the bid security(ies) declaration form and we will be considered for award, subject to fulfilling the eligibility criteria as given in bidding document;
- (m) If our bid is accepted, we opt to take payment into the bank account, nominated by us.
- (n) We declare that the submission of this bid confirms that no agent, middleman or any intermediary has been, or will be engaged to provide any services or any other item of work related to the award and performance of this contract. We further confirm and declare that no agency commission or any payment which may be construed as an agency commission has been, or will be, paid and that the bid price does not include any such amount. We acknowledge the right of the Employer, if he finds to the contrary, to declare our bid to be noncompliant and if the contract has been awarded to declare the contract null and void
- (o) We understand that you are not bound to accept the lowest evaluated bid or any other bid that you may receive.
- (p) A Power of Attorney to sign and submit this letter is attached.
- (q) Having inspected the site, examined the complete bid document including Employer's requirements, Conditions of Contract, Special Conditions of Contract, particular conditions of Contract, Technical Specifications, Safety, Health & Environment (SHE) manual, Eligibility Cum Qualification Criteria, Instructions to Bidder and Addenda/Corrigendum etc., thereto (if any) for above mentioned work and prepared the bid entirely in accordance with all the requirements of the bid document and agree entirely with them.
- (r) We here by confirm that we have visited the sites of work and have become conversant with the local conditions of working.
- (s) For the purpose of your evaluation, study, review and decision-making we are ready to let you inspect our business premises / site, etc.
- (t) We authorize K-RIDE or any of their authorized representative to approach, enquire, verify and check the matter furnished in our submission with the concerned client / owner of the Project / Contract and the concerned Banker of reference provided by us.

- (u) We undertake to hold in confidence all documents and information whether Technical or Commercial supplied to us at any time by or on behalf of K-RIDE in connection with this bid and without your written authority or as otherwise required by law not to publish or otherwise disclose the same.
- (v) If our bid is accepted, we agree to establish our project office in Bangalore.
- (w) We have submitted the Statement of Integrity, Eligibility, Social, and Environmental Responsibility signed and abide by the same.
- (x) We understand that this Bid shall be governed by and construed in all respects according to the laws for the time being force in India. The courts at Bangalore will have exclusive jurisdiction in the matter.
- (y) We undertake that, in competing for (and, if the award is made to us, in executing) the above contract, we will strictly observe the laws against fraud and corruption in force in India namely "Prevention of Corruption Act 1988".

We hereby confirm that this Tender complies with the Tender validity and Earnest money deposit required by the Tender documents.

- (z) We confirm and declare that by virtue of our signature below, to the best of knowledge and belief that the information provided by us as required in this Bid Document, all supporting and explanatory information is truthful and exact.



Name.....
 In the capacity
 of.....

Signed

Duly authorized to sign the Bid for and on behalf of

Date

(SEAL AND SIGNATURE OF THE BIDDER)

LETTER OF PRICE BID

(To be separately given for each package on the Letter head of the Firm)

Date.....

Invitation for Bid No.....

To,
.....

We, the undersigned, declare that:

- (a) We have examined and have no reservations to the Bidding Documents, including Addenda issued in accordance with Instructions to Bidders (ITT) 9;
- (b) We offer to execute the Work in conformity with the Bidding Documents;
- (c) The total price of our Bid, indicated in the Price Bid on Karnataka e-procurement portal
- (d) We understand that this bid, together with your written acceptance thereof included in your notification of award, shall constitute a binding contract between us, until a formal contract is prepared and executed; and
- (e) We have not made any deviations from the requirement of the bidding document and we have also not made any tampering or changes in the bidding documents on which the bid is being submitted and if any tampering or changes are detected at any stage, we understand the bid will invite summary rejection and forfeiture of bid security/the contract will be liable to be terminated along with forfeiture of performance security, even if LOA has been issued.
- (f) We understand that you are not bound to accept the lowest evaluated bid or any other bid that you may receive.

Name.....
..... In the capacity of

Signed
.....

Duly authorized to sign the Bid for and on behalf of
.....

Date
.....

Seal
.....
.....

K-RIDE

FORMAT FOR AFFIDAVIT TO BE SUBMITTED BY BIDDER ALONGWITH THE BID

(To be separately given for each package)

*(To be executed in presence of Public Notary on non-judicial stamp paper of the appropriate value in accordance with relevant stamp Act. The stamp paper has to be in the name of the bidder) ***

I **(Name and designation)** **..... appointed as the attorney/authorized signatory of the bidder (including its constituents), M/s. _____ (hereinafter called the bidder) for the purpose of the Bid for the work of _____ as per the bid No. _____ of K-RIDE, do hereby solemnly affirm and state on behalf of the bidder including its constituents as under:

- *1. That the bidder or any of its constituents has not been Blacklisted/ banned for business dealings for all Government Departments or by Ministry of Railways or by K-RIDE at any time and/or no such blacklisting is in force as on the deadline for submission of bids.
- *2. That none of the previous contracts of the bidder or any of its constituents had been terminated/rescinded for Contractor's failure or part terminated for its failure as a JV/ Consortium partner with forfeiture of its full Performance Security, by Rail Infrastructure Development Company (Karnataka) Ltd. during the period of last 3 years before the deadline for submission of bids.

(Add Proviso of Clause 2, (ITT) suitably, if any Contract was so terminated).

- *3. The bidder or any of its constituents has not been imposed liquidated damages of 5% or more of contract value by any Government Department or by Ministry of Railways or by K-RIDE due to delay in the implementation of any previous contract (either in the capacity of a single entity or as constituent of any other JV/ Consortium) within the period of last 2 years before the deadline for submission of bid [2 years shall be reckoned from the date on which imposed L.D. has exceeded 5% of the contract price] and there are no such accrued delay damages which has not been fully recovered before the deadline for submission of bids on account of contractor's request for deferring recovery to maintain cash flow and K-RIDE has acceded to the same in the interest of the project and the work under the previous contract in question has been completed before the deadline for submission of bid, unless imposition of such delay damages has been set aside by the Competent Authority.
4. That the Bidder or any of its constituents is neither Bankrupt/Insolvent nor is in the process of winding-up nor is such a case pending before any Court on the deadline of submission of the bid.
- *5. That the name of the Bidder or any of its constituents is not on the list of "Poor Performer" of any Government Department or by Ministry of Railways or by K-RIDE as on the deadline for submission of bid.
6. We declare that the bidder or any of its constituents have not either changed their name or created a new business entity. Consequent to having been banned business dealings for specified period which is not over or suspended business dealings or having been declared as poor performer.

7. We declare and certify that balance sheets for last five financial years including that for the latest concluded financial year are being submitted.

OR

We declare and certify that balance sheet for the latest concluded financial year has not been finalized till date and that is why we are furnishing financial data for last five financial years ignoring the latest concluded financial year.

*(# - Delete whichever is not applicable) **.*

8. We declare and certify that we have not made any misleading or false representation in the forms, statements and attachments in proof of the qualification requirements.
9. We declare that the information and documents submitted along with the bid by us are correct and we are fully responsible for the correctness of the information and documents, submitted by us.
10. We understand that in case we cease to fulfil the requirements of qualifying and eligibility criteria at any time after opening of bids and till finalization of bids, it will be our bounden duty to inform the Employer of our changed status immediately and in case of our failure to do so, our bid shall be rejected and bid security shall be forfeited. In case such failure comes to the notice of Employer at any time after award of the contract, it will lead to termination of the contract and forfeiture of Bid or Performance Security. We shall also be liable for Banning of Business dealings up to a period of five years.
11. We understand that if the contents of the affidavit are found to be false at any stage during bid evaluation, it will lead to rejection of our bid and forfeiture of the bid security. Further, we ***[insert name of the bidder]*** ****** _____ and all our constituents understand that we shall be liable for banning of business dealings up to a period of five years.
12. We declare and certify that we have not made any misleading or false representation in the forms, statements and attachments in proof of the qualification requirements.
13. We also understand that our offer will be evaluated based on the documents/credentials submitted along with the offer and same shall be binding upon us.
14. We declare that the information and the document submitted along with the tender by us are correct and we are fully responsible for the correctness of the information and documents, submitted by us.
15. We undersigned that if the certificate regarding Eligibility Criteria submitted by us are found to be forged/false or incorrect at any time during process for evaluation of tenders, it shall lead to forfeiture of the tender EMD besides banning of business for five years in K-RIDE. Further, we (Insert name of the Tenderer)** and all our constituents understand that our offer shall be summarily rejected.
16. We also understand that if the certificate submitted by us are found to be false/forged or incorrect at any time after the award of contract, it will lead to termination of the contract, along with forfeiture of EMD/SD and performance guarantee besides any other action provided in the contract including banning of business for five year in K-RIDE.

(SEAL AND SIGNATURE OF THE BIDDER)

Verification:

We above named tenderer do hereby solemnly affirm and verify that the contents of our above affidavit are true and correct. Nothing has been concealed and no part of it is false.

(SEAL AND SIGNATURE OF THE BIDDER)

*Modify the contents wherever necessary, in terms of sub-clause 2 ITT.

** The contents in Italics are only for guidance purpose and details as appropriate, are to be filled in suitably by Bidder.

Attestation before Magistrate/Public Notary

K-RIDE

FORMAT OF BID SECURITY (BANK GUARANTEE)

WHEREAS _____ having its registered office at _____
_____ (hereinafter called the –Bidder) has submitted his bid dated _____ for the work
**“SHIFTING OF ELECTRICAL UTILITIES INFRINGING PROPOSED CORRIDOR-2 OF BENGALURU SUBURBAN
RAIL PROJECT BETWEEN LOTTEGOLLAHALLI TO YESWANTPUR OF CHIKKBANAVARA TO
BAIYYAPPANAHALLI SECTION”**. hereinafter called “the Works”) KNOW ALL PEOPLE by these presents that we,
_____ having its registered office at _____
(hereinafter called the Bank) are bound unto the Managing Director, Rail Infrastructure Development Company
Karnataka Ltd (K-RIDE), Bangalore. (hereinafter called “the Employer”) in the sum of Rs. _____
(Rupees _____) for which payment well and truly to be made to the said Employer the
Bank binds itself, his successors and assigns by these presents; SEALED with the Common Seal of the said Bank
this day _____.

THE CONDITIONS OF THIS OBLIGATION ARE:

(1) If after Bid opening the Bidder withdraws his Bid during the period of Bids validity specified in the Form of Bid.

OR

(2) If the Bidder having been notified of the acceptance of his Bid by the Employer during the period of Bid Validity.

a. Fails or confuses to execute the form of Agreement in accordance with the instructions to Bidders, if required; or

b. Fails or refuse to furnish the Performance Security, in accordance with the instruction to Bidders; or

c. Does not accept the correction of the Bid Price pursuant to clause 24

We undertake to pay to the Employer up to the above amount upon receipt of his first written demand, without the Employer having to substantiate his demand, provided that in his demand the Employer will note that the amount claimed by him is due to him owing to the conditions of one or both of the two conditions, specifying the occurred condition or conditions.

This Guarantee will remain in force up to and including the date 180 plus 45 days after the deadline for submission of bids as such deadline is stated in the instructions to Bidders of as it may be extended by the Employer, notice of which extension(s) to the Bank is hereby waived. Any demand in respect of this Guarantee should reach the Bank not later than the above date

DATE _____ SIGNATURE OF THE BANK _____

WITNESS _____

SEAL _____

**PRO-FORMA LETTER OF PARTICIPATION FROM EACH PARTNER OF JOINT VENTURE (JV)/
CONSORTIUM**

(On each Firm's Letter Head)

No.....

Dated:.....

From,

.....
.....

To,

The General Manager,
Rail Infrastructure Development Company (Karnataka) Limited,
"Samparka Soudha", 1st Floor,
B.E.P Premises (Opp. Orion Mall),
Rajajinagar 1st Block,
Bangalore – 560 010.

Gentlemen,

Re: ... "[Insert name of work]"

Ref: Your notice for Invitation for Bid (IFB)

1. We wish to confirm that our company/firm (delete as appropriate) has formed a Joint Venture/ Consortium by name of with for the purposes associated with IFB referred to above.
(Members who are not the lead partner of the JV/ Consortium should add the following paragraph) *
2. 'The JV/ Consortium is led by ... whom we hereby authorize to act on our behalf for the purposes of submission of Bid for And authorize to incur liabilities and receive instructions for and on behalf of any and all the partners or constituents of the Joint Venture/ Consortium.'

OR

(Member(s) being the lead member of the group should add the following paragraph) *

2. 'In this group we act as leader and, for the purposes of applying for qualification, represent the Joint Venture/ Consortium.'

3. In the event of our group being awarded the contract, we agree to be jointly with..... (names of other members of our JV/ Consortium) and severally liable to the (K-RIDE) Rail Infrastructure Development Company (Karnataka) Limited, Bangalore, its successors and assigns for all obligations, duties and responsibilities arising from or imposed by the contract subsequently entered into between Rail Infrastructure Development Company (Karnataka) Limited, Bangalore and our JV/ Consortium.
4. *I/We, further agree that entire execution of the contract shall be carried out exclusively through the lead partner.

Yours faithfully,

(Signature)

(Name of Signatory)

(Capacity of Signatory)

Seal

* Delete as applicable

K-RIDE

**FORMAT FOR POWER OF ATTORNEY FOR AUTHORISED
SIGNATORY OF JOINT VENTURE (JV)/ CONSORTIUM PARTNERS**

POWER OF ATTORNEY

*(To be executed on non-judicial stamp paper of the appropriate value in accordance with relevant stamp Act.
The stamp paper to be in the name of the company who is issuing the power of Attorney)*

Know all men by these presents, we ... do hereby constitute, appoint and authorize Mr/Ms. Who is presently employed with us and holding the position ofas our attorney, to do in our name and on our behalf, all such acts, deeds and things necessary in connection with or incidental to our bid for the work of ...Including signing and submission of all documents and providing information/responses to Rail Infrastructure Development Company (Karnataka) Limited, Bangalore, representing us in all matters, dealing with Rail Infrastructure Development Company (Karnataka) Limited, Bangalore, in all matters in connection with our bid for the said project and if successful, till the whole of the bid process.

We hereby agree to ratify all acts, deeds and things lawfully done by our said attorney pursuant to this Power of Attorney and that all acts, deeds and things done by our aforesaid attorney shall and shall always be deemed to have been done by us.

Dated this the day of 20..

(Signature of authorized Signatory)

.....

(Signature and Name in Block letters of Signatory)

Seal of Company

Witness

Witness 1:

Name:

Address:

Occupation:

Witness 2:

Name:

Address:

Occupation:

*Notes:

- i. To be executed by all the partners individually, in case of a Joint Venture/ Consortium.
- ii. The mode of execution of the Power of Attorney should be in accordance with the procedure, if any, laid down by the applicable law and the charter documents of the executant(s) and when it is so required the same should be under common seal affixed in accordance with the required procedure.
- iii. Also wherever required, the executants(s) should submit for verification the extract of the charter documents and documents such as resolution/ power of attorney in favour of the person executing this power of attorney for the designation of power hereunder on behalf of the bidder.

**FORMAT FOR POWER OF ATTORNEY TO
LEAD PARTNER OF JOINT VENTURE (JV)/ CONSORTIUM**

*(To be executed on non-judicial stamp paper of the appropriate value in accordance with relevant stamp Act.
The stamp paper to be in the name of the company who is issuing the power of Attorney)*

POWER OF ATTORNEY

Whereas Rail Infrastructure Development Company (Karnataka) Limited Bangalore, has invited Bids for the work of

Whereas, the members of the Joint Venture/ Consortium comprising of M/s., M/s., and M/s. Are interested in submission of bid for the work of ... *[Insert name of work]* ... in accordance with the terms and conditions contained in the bidding documents.

Whereas, it is necessary for the members of the Joint Venture/ Consortium to designate one of them as the Lead Partner, with all necessary power and authority to do, for and on behalf of the Joint Venture/ Consortium, all acts, deeds and things as may be necessary in connection with the Joint Venture's/ Consortium's bid for the project, as may be necessary in connection the Joint Venture's/ Consortium's bid for the project.

NOW THIS POWER OF ATTORNEY WITNESSETH THAT:

We, M/s., hereby designate M/s., being one of the partners of the Joint Venture/ Consortium, as the lead partner of the Joint Venture/ Consortium, to do on behalf of the Joint Venture/ Consortium, all or any of the acts, deeds or things necessary or incidental to the Joint Venture's/ Consortium's bid for the contract, including submission of bid, participating in conferences, responding to queries, submission of information/ documents and generally to represent the Joint Venture/ Consortium in all its dealings with K-RIDE/ Railway or any other Government Agency or any person, in connection with the contract for the said work until culmination of the process of bidding till the contract agreement is entered into with the Rail Infrastructure Development Company (Karnataka) Limited, Bangalore and thereafter till the expiry of the contract agreement.

We hereby agree to ratify all acts, deeds and things lawfully done by lead member, our said attorney, pursuant to this power of attorney and that all acts deeds and things done by our aforesaid attorney shall and shall always be deemed to have been done by us/ Joint Venture/ Consortium.

Dated this the Day of 20..

.....

(Signature)

.....

(Name in Block letters of Executant)

Seal of Company

Witness 1:

Name:

Address:

Occupation:

Witness 2:

Name:

Address:

Occupation:

Notes:

1. To be executed by all the Partners of the JV/Consortium except the lead Partner.
2. The mode of execution of the Power of Attorney should be in accordance with the procedure, if any, laid down by the applicable law and the charter documents of the executant(s) and when it is so required the same should be under common seal affixed in accordance with the required procedure.

K-RIDE

DRAFT FORMAT OF JOINT VENTURE/CONSORTIUM AGREEMENT

M/s Having its registered office at (hereinafter referred to as)
acting as the Lead Partner of the first part,

and

M/s Having its registered office at (here in after referred to as
.....) in the capacity of a Joint Partner of the other part.

The expressions of And Shall wherever the context admit, mean and include their
respective legal representatives, successors-in-interest and assigns and shall collectively be referred to as “the
Parties” and individually as “the Party”

WHEREAS:

Rail Infrastructure Development Company (Karnataka) Limited (K-RIDE) [hereinafter referred to as “Employer”]
has invited bids for ... “[Insert name of work]” Vide LOA No.....awarded contract.

NOW, THEREFORE, THE PARTIES AGREE AS FOLLOWS:

- (8) The following documents shall be deemed to form and be read and construed as an integral part of
this AGREEMENT.
- i. Notice for Bid, and
 - ii. Bidding document
 - iii. Any Addendum/Corrigendum issued by Rail Infrastructure Development Company (Karnataka)
Limited
 - iv. The bid submitted on our behalf jointly by the Lead Partner.
 - v. Letter of Acceptance issued by Rail Infrastructure Development Company (Karnataka) Ltd.
2. The ‘Parties’ have studied the documents and LOA issued to enter into Joint Venture/ Consortium as under
and have agreed to participate.
3. M/sshall be the lead member of the JV/ Consortium for all intents and purpose and shall represent
the Joint Venture/ Consortium in its dealing with the Employer. For the purpose of execution, the parties
agree to nominate As the leader duly authorized to sign and submit all documents and enter into
correspondence with the Employer.
4. The ‘Parties’ have resolved that the distribution of share and responsibilities between the JV/Consortium
partners is as under
- (a) Lead Partner Share %
- Responsibilities**
- (9) *Key Activities and %age execution assigned*
- i.

(II) BOQ Schedule/Bill No. and %age execution assigned

- i.
- ii.
- iii.

(b) Joint Venture/ Consortium Partner Share.....%

Responsibilities

(10) Key Activities and %age execution assigned

- i.

(II) BOQ Schedule/Bill No. and %age execution assigned

- i.
- ii.
- iii.

(c) Joint Venture/ Consortium Partner Share.....%

Responsibilities

(11) Key Activities and %age execution assigned

- i.

(II) BOQ Schedule/Bill No. and %age execution assigned

- i.
- ii.
- iii.

Note: In case any Bill or items of a Bill are proposed to be executed by more than one JV/ Consortium partner then indicate the breakup of that Item/Bill no. for each JV/ Consortium partner.

5. JOINT AND SEVERAL RESPONSIBILITIES

The Parties undertake that they shall be jointly and severally liable to the Employer in the discharge of all the obligations and liabilities as per the contract with the Employer and for the performance of contract awarded to their JV/Consortium.

6. ASSIGNMENT AND THIRD PARTIES

The parties shall co-operate throughout the entire period of this AGREEMENT on the basis of exclusivity and neither of the Parties shall make arrangement or enter into agreement either directly or indirectly with any other party or group of parties on matters relating to the Project except with prior written consent of the other party and the Employer.

7. EXECUTIVE AUTHORITY

The said Joint Venture/ Consortium through its authorized representative shall receive instructions, payments from the Employer. The management structure for the project shall be prepared by mutual consultations to enable completion of project to quality requirements within permitted cost and time.

8. GUARANTEES AND BONDS

Performance Security and other Securities of a JV/ Consortium shall be in the name of the JV/ Consortium that submits the bid.

9. BID SUBMISSION

Each Party shall bear its own cost and expenses for preparation and submission of the bid and all costs until conclusion of a contract with the Employer for the Project. Common expenses shall be shared by both the parties in the ratio of their actual participation.

10. INDEMNITY

Each party hereto agrees to indemnify the other party against its respective parts in case of breach/default of the respective party of the contract works of any liabilities sustained by the Joint Venture/ Consortium.

11. For the execution of the respective portions of works, the parties shall make their own arrangements to bring the required finance, plants and equipment, materials, manpower and other resources.

12. DOCUMENTS & CONFIDENTIALITY

Each Party shall maintain in confidence and not use for any purpose related to the Project all commercial and technical information received or generated in the course of preparation and submission of the bid.

13. ARBITRATION

Any dispute, controversy or claim arising out of or relating to this agreement shall be settled in the first instance amicably between the parties. If an amicable settlement cannot be reached as above, it will be settled by arbitration in accordance with the Indian Arbitration and Conciliation Act 1996 or any amendments thereof. The venue of the arbitration shall be Bangalore.

14. VALIDITY

This Agreement shall remain in force till the defect liability period is over and Securities are released.

15. This AGREEMENT is drawn in number of copies with equal legal strength and status. One copy is held by M/s and the other by M/s. &M/s And a copy submitted with the Bid.

16. This AGREEMENT shall be construed under the laws of India.

17. NOTICES BETWEEN JV/ CONSORTIUM PARTNERS

Notices shall be given in writing by fax confirmed by registered mail or commercial courier to the following fax numbers and addresses:

Lead Partner

Other Partner

.....

.....

.....

.....

(Name & Address)

(Name & Address)

IN WITNESS WHEREOF THE PARTIES, have executed this AGREEMENT the day, month and year first before written.

M/s.....

M/s.....

.....

.....

(Seal)

(Seal)

Witness

1.....(Name & Address)

2..... (Name & Address)

K-RIDE

Bidders Qualification

To establish its qualifications to perform the contract in accordance with Section 2 (Qualification Information) the Bidder shall provide the information requested in the corresponding Information Sheets included hereunder.

To establish its qualifications to perform the contract in accordance with Section 2 (Qualification Criteria) the Bidder shall provide the information requested in the corresponding Information Sheets included hereunder.

Form ELI – 1: Bidder’s Information Sheet

Bidder’s Information	
Bidder’s legal name	
Bidder’s country of constitution	
Bidder’s year of constitution	
Bidder’s legal address in country of constitution	
Bidder’s authorized representative (name, address, telephone numbers, fax numbers, e-mail address)	
Bidder’s Bank Details: (a) Name of the Bank and branch: (b) Account Number: (c) IFSC code: (d) Bank’s Contact Number and Fax Number: (e) PAN: (f) GST Registration No:	

The bidder shall attach copies of the following original documents with the form:

1. In case of single entity, articles of incorporation or constitution of the legal entity named above, in accordance with ITT clause 2.
2. Authorization to represent the firm or JV/ Consortium named in above, in accordance with ITT clause 14.
3. In case of JV/ Consortium, JV/ Consortium agreement, in accordance with ITT clause 2.

Note: Following needs to be submitted by the bidder;

- (a) Affidavit in case of Proprietary firm.
- (b) Partnership Deed in case of partnership firm.
- (c) Memorandum & Article of Association in case of Public/Private limited company.
- (d) Authorization/POA in favour of authorised signatory of bidder to sign the bid.
- (e) Board of resolution nominating particular director to authorize a signatory to sign the bid.
- (f) In case of JV partners the above relevant documents as applicable needs to be submitted.

SEAL AND SIGNATURE

K-RIDE

Form ELI – 2: JV/ Consortium Information Sheet

Each member of a JV/ Consortium must fill in this form separately

JV / Consortium Information	
Bidder's legal name	
JV/ Consortium Partner's legal name	
JV/ Consortium Partner's country of constitution	
JV/ Consortium Partner's year of constitution	
JV/ Consortium Partner's legal address in country of constitution	
JV/ Consortium Partner's authorized representative information (name, address, telephone numbers, fax numbers, e-mail address)	
Bidder's Bank Details: (a) Name of the Bank and branch: (b) Account Number: (c) IFSC code: (d) Bank's Contact Number and Fax Number: (e) PAN: (f) GST Registration No:	

The bidder shall attach copies of the following original documents with the form:

1. Articles of incorporation or constitution of the legal entity named above, in accordance with ITT clause 2.
2. Authorization to represent the firm named above, in accordance with ITT clause 14.

Note: Following needs to be submitted by the bidder;

- (g) Affidavit in case of Proprietary firm.
- (h) Partnership Deed in case of partnership firm.
- (i) Memorandum & Article of Association in case of Public/Private limited company.
- (j) Authorization/POA in favour of authorised signatory of bidder to sign the bid.
- (k) Board of resolution nominating particular director to authorize a signatory to sign the bid.
- (l) In case of JV partners the above relevant documents as applicable needs to be submitted.

SEAL AND SIGNATURE

K-RIDE

Form FIN-1: Financial Situation

(Each Bidder or each member of a JV/Consortium must fill in this form separately)

NAME OF BIDDER/JV/CONSORTIUM PARTNER

	Financial Data for Last 5 Years [Indian National Rupees]				
	Year 1:	Year 2:	Year 3:	Year 4:	Year 5:
1. Total Assets					
2. Current Assets					
3. Total Liabilities					
Current Liabilities					
(12) Net Worth [= 1 – 3]					
6. Working Capital [= 2 – 4]					
(13) Profit Before Tax (PBT)					

1. The bidder shall attach copies of the following original documents with the form

Copies of the audited balance sheets, including all related notes, and income statements for the last five years, as indicated above, complying with the following conditions.

- i. All such documents reflect the financial situation of the Bidder or partner to a JV/ Consortium, and not sister or parent companies.
- ii. Historic financial statements must be audited by a certified accountant.
- iii. Historic financial statements must be complete, including all notes to the financial statements.
- iv. Historic financial statements must correspond to accounting periods already completed and audited (no statements for partial periods shall be requested or accepted).

2. Contents of this form should be certified by a Statutory Auditor

- i. In the event that the audited accounts for the latest Financial Year are not available, the Bidder shall furnish information pertaining to the last five financial years after ignoring the latest financial year. In case, the bidder submits audited financial information for the last six or more years, only the figures for the latest five years shall be considered for evaluation.
- ii. Financial data for last five financial years has to be submitted by the bidder along with audited balance sheets. The financial information of the Bidder must be certified either by the Independent Financial Auditor (statutory Auditor) of the company appointed under the companies' Act.

- iii. In case any discrepancy in data is found between the balance sheet and the financial information submitted, the data as available in the balance sheet will be considered.
- iv. In case the audited balance sheet of the last financial year is not made available by the Bidder, he has to submit an affidavit certifying that 'The Balance Sheet has actually not been audited so far'. In such a case the financial data of previous '4' audited financial years will be taken into consideration for evaluation. If audited balance sheet of any year other than the last financial year is not submitted, then the bid will be considered as non-responsive
- v. In case the company's financial year is from Jan 19 to Dec 19, then it will be considered under financial year 2019 – 20 similar procedure will be applicable for other financial years also.

SEAL AND SIGNATURE OF THE BIDDER

Certified that all figures and facts submitted in this form have been furnished after full consideration of all observations/notes in Auditor's reports.

(Signature of Statutory Auditor)

Name of Statutory Auditor : _____

Registration No: _____

(Seal)

Form FIN-2: Annual Construction Turnover for the last 5 years

Each Bidder or each member of a JV/ Consortium must fill in this form separately

NAME OF BIDDER/JV/CONSORTIUM PARTNER:

Sl.No.	Year	Annual Turnover	Multiplying factor	Updated Annual turnover
		INR	INR	INR
1	2017-2018			
2	2018-2019			
3	2019-2020			
4	2020-2021			
5	2021-2022			

Annual Turnover Data for the Last 5 Years (Construction only)			
Year	Amount Currency	Exchange Rate	Indian National Rupees Equivalent
Average Annual Construction Turnover for last 5 Financial Years			
Minimum Financial Turnover for any last 2 Financial Years as per clause 3.2(a)			

1. The information supplied shall be substantiated by data in the audited balance sheets and profit and loss accounts for the relevant years and submitted as attachments to form Fin-1 in respect of the bidder or all partners constituting the bidder.
2. Contents of this form should be certified by a Statutory Auditor.
3. In case the audited balance sheet of the last financial year is not made available by the Bidder, he has to submit an affidavit certifying that 'The Balance Sheet has actually not been audited so far'. In such a case the financial data of previous '4' audited financial years will be taken into consideration for evaluation. If audited balance sheet of any year other than the last financial year is not submitted, then the bid will be considered as non-responsive.

SEAL AND SIGNATURE

Form FIN-3: Current Contract Commitments / Works in Progress

Bidders and each partner to a JV/Consortium should provide information on their current commitments on all contract that have been awarded, or which a letter of intent or acceptance has been received, or for contracts approaching completion, but for which an unqualified, full completion certificate has yet to be issued.

Contract Commitments

Sl. No.	Description of work	Contract No. & date	Name & address of Employer, Tel./Fax/ Email	Value of Contract in INR	Stipulated Period of completion	Value of Balance work	Anticipated date of Completion
1							
2							
3							
4							
5							
Total							

1. For calculation of 'Updated contract value' in column 5 above, assume inflation as per multiplying Factors given in FIN-2.
2. Bidder should provide information on their current commitments or all contracts that have been awarded or for which a letter of intent or acceptance has been received or for contracts approaching completion but for which a completion certificate is yet to be issued.
3. Total Equivalent INR should be calculated using the selling exchange rate of Reserve Bank of India as on 28th day prior to the last date of submission of bids. In case publication is not available on 28th day, previous working day published exchange rate shall be considered for evaluation.

Note: Enclose Certificate(s) from Engineer(s) In charge (not below the rank of Executive Engineer) for Value of outstanding work. In case it is not feasible to furnish certificate from all the units the bidder should record the following certificate on Fin 3:

"Certified that current commitments on all the contracts that have been awarded or for which a letter of intent or acceptance has been received or for the works in progress or the works approaching completion, value of outstanding work has been indicated in the above table correctly. It is further certified that if later on the employer discovers that information provided in the table is incorrect then the employer will treat our bid invalid and it will be liable for rejection"

SEAL AND SIGNATURE

FORM NO. 1

DELETED

K-RIDE

**CHECKLIST FOR CLAUSES PERTAINING TO SUMMARY
REJECTION OF BID**

We, the undersigned, declare that we have read and understood the content of ITT clauses section:2 mentioned below. We also understand that our bid shall be summarily rejected in case we fail to comply the requirements of undermentioned clauses:

ITT Clause No. Section 2	Reason for Summary Rejection
2.5	Non-submission of Affidavit- (Form PS-3)
2.5	Non-submission of immediate information to the Employer in case Bidder ceases to fulfill eligibility in terms of ITT clause 2
10.3	Non-submission of Letter of Technical Bid
11.5	Quoting more than one percentage for any schedule
11.5	Non-submission of the Letter of Price Bid (LB)
13	Bid not accompanied with EMD/Bid Security
14	Bid not accompanied with power of attorney/General power of Attorney to sign on behalf of the bidders

SEAL AND SIGNATURE OF THE BIDDER

FORMAT FOR CERTIFICATE TO BE SUBMITTED BY BIDDER ALONGWITH THE BID

(On the letter head of the Firm)

We/I, _____, having registered office at _____ do hereby certify that "I have read the clause regarding restrictions on procurement from a bidder of a country which shares a land border with India; I certify that this bidder is not from such country or, if from such a country, has been registered with the Competent Authority. I hereby certify that this bidder fulfils all requirements in this regard and is eligible to be considered. (Where applicable, evidence of valid registration by the competent Authority shall be attached.)"

Dated this _____ day of _____, 2023

For- _____

Authorized Signatory Signature _____

Full Name: _____

Place: _____

K-RIDE

(SEAL AND SIGNATURE OF THE BIDDER)

**FORMAT FOR CERTIFICATE TO BE SUBMITTED BY
BIDDER ALONGWITH THE BID FOR SUB CONTRACTING**

(On the letter head of the Firm)

We/I, _____, having registered office at _____ do hereby certify that "I have read the clause regarding restrictions on procurement from a bidder of a country which shares a land border with India and on sub-contracting to contractors from such countries; I certify that this bidder is not from such a country or, if from such a country, has been registered with the competent Authority and will not sub-contractor any work to a contractor from such countries unless such contractor is registered with the competent Authority. I hereby certify that his bidder fulfils all requirements in this regard and is eligible to be considered. (Where applicable, evidence of valid registration the Competent Authority shall be attached.)"

Dated this _____ day of _____, 2023

For- _____

Authorized Signatory Signature _____

Full Name: _____

Place: _____

K-RIDE

(SEAL AND SIGNATURE OF THE BIDDER)

Key Personnel for the work

MINIMUM QUALIFICATION AND EXPERIENCE REQUIRED FOR KEY PERSONNEL TO BE DEPLOYED FOR THE WORK

Sl. No.	Key Personnel	Qualifications & Total Experience	Particular Experience (Minimum requirement)	Minimum Number of Personnel Required	Name of the key personnel proposed	Qualification	Total number of years of experience	Number of Years in similar works experience
1	Sr. Engineers	BE Electrical Engg. with minimum 5 Years of experience	Experience in similar nature of work	1				
2	Sr. Engineers	Diploma in Electrical Engg. with minimum 10 Years of experience	Experience in similar nature of work	1				
3	Technicians/ Electricians	Minimum ITI in Electrician/wiremen with 5 years of experience	Experience in similar nature of work	3				

Note: Further details to be updated as per clause 3.3 (c) of section 2 ITT.

(Signature)

(Name of Signatory)

(Capacity of Signatory)

Seal.....

Format of Curriculum Vitae (cv) for proposed key professional staff

Proposed Position:

Name of Firm:

Name of Staff:

Profession:

Date of Birth:

Years with Firm/Entity: Nationality:

Membership in Professional Societies:

Detailed Tasks Assigned:

Key Qualifications:

[Give an outline of staff member's experience and training most pertinent to tasks on assignment. Describe degree of responsibility held by staff member on relevant previous assignments and give dates and locations.]

Education:

[Summarize college/university and other specialized education of staff member and degrees obtained.]

Employment Record:

[Starting with present position, list in reverse order every employment held. List all positions held by staff member since graduation, giving dates, names of employing organizations, titles of positions held, and locations of assignments. Also give types of activities performed and client references, where appropriate.]

Period	Name of Employing Organization	Name of the Project	Title / Position	Activity performed	Location of the Assignment

Languages:

[For each language, indicate proficiency: excellent, good, fair, or poor; in speaking, reading, and writing]

Certification:

I, the undersigned, certify that to the best of my knowledge and belief, these data correctly describe me, my qualifications, and my experience.

Date:

[Signature of staff member and authorized representative of the Firm] Day/Month/Year

Full name of staff member: _____

Full name of the authorized representative: _____

FORM CL-2

UNDERTAKING FROM SPECIALIST SUB-CONTRACTOR

(Refer Clause of EQC)

(On the Letterhead of specialist sub-contractor)

I/We,.....(Legal Name of Specialist Subcontractor) hereby confirm that we are associating with(Legal name of the bidder) for the work of(Name of work as stated in Invitation for Bids {IFB}), for the key activity stated in clause 3.2 (c) of ITT (if applicable).

I/We hereby undertake that in case M/s.....(Legal name of the bidder) are awarded the work of(Name of work as stated in Invitation for Bids {IFB}),the key activity stated in clause 3.2 (c) of ITT shall be undertaken by us as per bid conditions (if applicable).

**STAMP & SIGNATURE OF AUTHORISED
SIGNATORY OF SPECIALIST SUB CONTRACTOR**

**STAMP & SIGNATURE OF AUTHORISED
SIGNATORY OF BIDDER**

K-RIDE

Form CL-3

Availability of Financial Resources
(Section-2, ITT clause 3.3 (b))

Bidders must demonstrate sufficient financial resources, comprising of Working Capital supplemented by credit line statements or overdraft facilities to meet the Bidder's financial requirements for

- a) its current contract commitments, and
- b) the subject contract.

In case of a Joint Venture, each Joint Venture Partner must fill out this form separately and provide the Joint Venture Partner's name:

Joint Venture Partner: _____

Financial Resources		
No.	Source of financing	Amount (equivalent)
1	Working Capital	
2	Credit Line	
Total Available Financial Resources		

^aTo be considered, Credit Line must be substantiated by a letter from the bank issuing the line of credit, specific for the subject contract, as prescribed. Any letter or document not complying with this requirement shall not be considered as supplementary financial resources.

Note:

In case the financial statement data is other than Indian Rupees, the equivalent Indian Rupees with the exchange rates as defined in the Section-2, ITT.

Evidence of Availability of Credit Line Financial Resources
(Section-2 ITT, Clause:3(b))

[Each Bidder to fill out this form in case of demonstrating financial resources comprising credit line statements or overdraft facilities from bank.]

Project Name:

Bidding Package Name and Identification Number: (to be filled in as indicated in ITT 1) ...

BANK CERTIFICATE

This is to certify that M/s is a reputed company with a good financial standing.

If the contract for the work, namely..... is awarded to the above firm, we shall be able to provide overdraft / credit facilities to the extent of Rs to meet their working capital requirements for executing the above contract.

___Sd. ___

Name of Bank: _____

Senior Bank Manager _____

Address of the Bank _____



[In case of Joint Venture, change the text as follows:]

This is to certify that M/s who has formed a Joint Venture with M/s and M/s for participating in this bid, is a reputed company with a good financial standing.

If the contract for the work, namely..... is awarded to the above joint venture, we shall be able to provide overdraft / credit facilities to the extent of Rs..... to M/s to meet their working capital requirements for executing the above contract.

Form EXP-1

WORK EXPERIENCE CERTIFICATE

To whom so ever it may concern
(Issued for the purpose of Quoting in K-RIDE tenders)

M/s/Sri (Name and address of the contractor) is a working contractor of this unit and was awarded the following work. The relevant details of the work are as under: -

Sl.No	Description	Details
1	Name of work	
2	Acceptance Letter No and Date	
3	Agreement Number, date and name of the agency	
4	Agreement value in Rupees (in words and figures)	
5	Due date of completion	
6	Actual date of completion of work	
7	Value of Final Bill if passed (in words)	
8	Work completed but Final measurements not recorded. a) Amount paid so far as in CC bill No.	
9	Work completed. Final measurements recorded with negative variation a) Amount so far paid as in CC bill No.	
10	Work completed. If Final measurements recorded with Positive variation which is not sanctioned yet. Original agreement value of Last sanctioned agreement value whichever is lower.	
11	Scope of work (Broad category of works i.e., the name of the work in the agreement on which work is	
12	Details of values of major components/ works executed in the completed work.	

Note:

The Certificate to satisfy similar work should be signed by an officer not lower than JAG officer in Railways and Executive Engineer rank or equivalent grade in other department of Govt. of India/State Government/PSUs of Government of India / State Undertaking and Competent Authority of Public Listed Company.

Signature :.....

Name of officer.....

Designation:

Address:

Office seal:

Phone/FAX No.:

Date :

K-RIDE
--00-00-00--

SECTION-4

**FORM OF TENDER, LETTER OF ACCEPTANCE,
NOTICE TO PROCEED WITH THE WORK AND
AGREEMENT FORM ETC.,**

FORM OF TENDER, LETTER OF ACCEPTANCE, NOTICE TO PROCEED WITH THE WORK AND AGREEMENT FORM ETC.,

SL. NO.	TITLE	FORM NUMBER	PAGE NO.
1	LETTER OF ACCEPTANCE	FORM-1	94
2	ISSUE OF NOTICE TO PROCEED WITH THE WORK	FORM-2	95
3	AGREEMENT FORM	FORM-3	96-97

K-RIDE

FORM OF TENDER (DELETED)

Please refer Form PS-1 of Section 3: Qualification Information/Bidding Forms.

FORM-1

LETTER OF ACCEPTANCE

(Letter head paper of the Employer)

_____ [date]

To: _____ [name and address of the Contractor]

Dear Sirs,

This is to notify you that your Tender dated _____ for execution of the **“SHIFTING OF ELECTRICAL UTILITIES INFRINGING PROPOSED CORRIDOR-2 OF BENGALURU SUBURBAN RAIL PROJECT BETWEEN LOTTEGOLAHALLI TO YESWANTPUR OF CHIKKBANAVARA TO BAIYAPPANA HALLI SECTION”**. Tender No: K-RIDE/BSRP/17/2023, Dated: 10.02.2023 for the Contract Price of Rupees_____. (_____) [amount in words and figures], as corrected and modified in accordance with the Instructions to Tenderers is hereby accepted by our Agency.

You are hereby requested to furnish Security deposit (Performance Security) plus additional security for unbalanced tenders in accordance with of Clause 25.5 of ITT, in the form detailed in Clause 29.1 of ITT and clause 43 of the conditions of contract for an amount of Rs. _____ (As defined in contract data) within 20 days of the receipt of this letter of acceptance valid up to 30 days from the date of expiry of Defects Liability Period i.e., up to and sign the contract.

Yours faithfully,

Authorized Signature

Name and Title of Signatory

Name of Agency.

ISSUE OF NOTICE TO PROCEED WITH THE WORK

(Letter head of the Employer)

_____ (Date)

To

_____ (name and address of the Contractor)

Dear Sirs:

With reference to LOA, for the construction of **“SHIFTING OF ELECTRICAL UTILITIES INFRINGING PROPOSED CORRIDOR-2 OF BENGALURU SUBURBAN RAIL PROJECT BETWEEN LOTTEGOLAHALLI TO YESWANTPUR OF CHIKKBANAVARA TO BAIYYAPPANA HALLI SECTION”**. A Tender Price of Rs.—
_____, you are hereby instructed to proceed with the execution of the said works in accordance with the contract documents.

Yours faithfully,

K-RIDE

(Signature, name and title of signatory authorized to sign
on behalf of Employer)

AGREEMENT FORM**Agreement**

This agreement, made the _____ day of _____ 20_____,
 between _____
 _____ (Name and Address of Employer) (herein after called "the
 Employer") of the one part and
 _____ [nam
 e and address of contractor] (herein after called "the Contractor") of the other part.

Whereas the Employer is desirous that the Contractor execute "**SHIFTING OF ELECTRICAL UTILITIES INFRINGING PROPOSED CORRIDOR-2 OF BENGALURU SUBURBAN RAIL PROJECT BETWEEN LOTTEGOLAHALLI TO YESWANTPUR OF CHIKKBANAVARA TO BAIYYAPPANA HALLI SECTION**".

Tender No. K-RIDE/BSRP/17/2023, Dated: 10.02.2023 (herein after called "The Works") and the Employer has accepted the Tender by the Contractor for the execution and completion of such Works and the remedying of any defects therein at a contract price of Rupees.....

NOW THIS AGREEMENT WITNESSETH as follows:

1. In this Agreement, words and expression shall have the same meanings as are respectively assigned to them in the Conditions of Contract hereinafter referred to, and they shall be deemed to form and be read and construed as part of this Agreement.
2. In consideration of the payments to be made by the Employer to the Contractor as hereinafter mentioned, the Contractor hereby covenants with the Employer to execute and complete the Works and remedy any defects therein in conformity in all aspects with the provisions of the Contract.
3. The Employer hereby covenants to pay the Contractor in consideration of the execution and completion of the Works and the remedying the defects wherein the Contract Price or such other sum as may become payable under the provisions of the Contract at the times and in the manner prescribed by the Contract.
4. The following documents shall be deemed to form and be read and construed as part of this Agreement, viz:
 - i) Letter of Acceptance;
 - ii) Notice to proceed with the works;
 - iii) Contractor's Tender;
 - iv) Contract Data;
 - v) Conditions of contract (including Special Conditions of Contract and Particular Condition of Contract)
 - vi) Specifications;
 - vii) Drawings;
 - viii) Bill of Quantities; and
 - ix) Any other document listed in the Contract Data as forming part of the contract.

In witness whereof the parties thereto have caused this Agreement to be executed the day and year first before written.

The Common Seal of _____

was hereunto affixed in the presence of:

Signed, Sealed and Delivered by the said _____

in the presence of:

Binding Signature of Employer _____

Binding Signature of Contractor _____

K-RIDE

SECTION – 5

CONDITIONS OF CONTRACT(CC) AND SPECIAL CONDITIONS OF CONTRACT (SCC)

CONDITIONS OF CONTRACT**TABLE OF CONTENTS**

SI NO.	DESCRIPTION	PAGE NO
	A. GENERAL	
1	DEFINITIONS	101-102
2	INTERPRETATION	102
3	LAW GOVERNING CONTRACT	102
4	EMPLOYERS DECISIONS	102
5	DELEGATION	102
6	COMMUNICATIONS	103
7	SUB-CONTRACTING	103
8	OTHER CONTRACTORS	103
9	PERSONNEL	103
10	EMPLOYER'S & CONTRACTOR'S RISKS	103
11	EMPLOYER'S RISKS	103
12	CONTRACTOR'S RISKS	104
13	INSURANCE	104
14	SITE INVESTIGATION REPORTS	104
15	QUERIES ABOUT THE CONTRACT DATA	104
16	CONTRACTOR TO CONSTRUCT THE WORKS	104
17	THE WORKS TO BE COMPLETED BY THE INTENDED COMPLETION	105
18	APPROVALS BY THE EMPLOYER	105
19	SAFETY	105
20	DISCOVERIES	105
21	POSSESSION OF THE SITE	105
22	ACCESS TO SITE	105
23	INSTRUCTIONS	105
24	PROCEDURE FOR RESOLUTION OF DISPUTES	106
	B. TIME CONTROL	107
25	PROGRAM	107
26	EXTENSION OF THE INTENDED COMPLETION DATE	107
27	DELAYS ORDERED BY THE EMPLOYER	107
28	MANAGEMENT MEETINGS	107
	C. QUALITY CONTROL	108
29	IDENTIFYING DEFECTS	108
30	TESTS	108
31	CORRECTION OF DEFECTS	108
32	UNCORRECTED DEFECTS	108
	D. COST CONTROL	
33	BILL OF QUANTITIES	109
34	VARIATIONS	109
35	PAYMENTS FOR VARIATIONS	109
36	SUBMISSION OF BILLS FOR PAYMENT	109
37	PAYMENTS	110
38	COMPENSATION EVENTS	110

SECTION – 5: CONDITIONS OF CONTRACT(CC) AND SPECIAL CONDITIONS OF CONTRACT (SCC)

39	TAX	110
40	PRICE ADJUSTMENT	110
41	LIQUIDATED DAMAGES	111
42	ADVANCE PAYMENTS	111
43	SECURITIES	111
44	COST OF REPAIRS	111
	E. FINISHING THE CONTRACT	
45	COMPLETION	112
46	TAKING OVER	112
47	FINAL ACCOUNT	112
48	AS BUILT DRAWINGS / OPERATING AND MAINTENANCE MANUALS	112
49	TERMINATION	112
50	PAYMENT UPON TERMINATION	113
51	PROPERTY	114
52	RELEASE FROM PERFORMANCE	114
	F. SPECIAL CONDITIONS OF CONTRACT	
53	LABOUR	115
54	COMPLIANCE WITH LABOUR REGULATIONS	115
55	PROTECTION OF ENVIRONMENT	115
56	CLAIMS, DISPUTES AND ARBITRATION	115-121

K-RIDE

CONDITIONS OF CONTRACT

A. GENERAL

1. DEFINITIONS

- 1.1 Terms which are defined in the Contract Data are not also defined in the Conditions of Contract but keep their defined meanings. Bold letters are used to identify defined terms.

Bill of Quantities means the priced and completed Bill of Quantities forming part of the Tender.

Compensation Events are those defined in Clause 38 hereunder.

The **Completion Date** is the date of completion of the Works as certified by the Employer in accordance with Sub Clause 46.1.

The **Contract** is the contract between the Employer and the Contractor to execute, complete and maintain the Works. It consists of the documents listed in Clause 2.2 below.

The **Contract Data** defines the documents and other information which comprise the Contract.

The **Contractor** is a person or corporate body or Joint Venture whose Tender to carry out the Works has been accepted by the Employer.

The **Contractor's Tender** is the completed Tender document submitted by the Contractor to the Employer.

The **Contract Price** is the price stated in the Letter of Acceptance and thereafter as adjusted in accordance with the provisions of the Contract.

Days are calendar days; **months** are calendar months.

A **Defect** is any part of the Works not completed in accordance with the Contract.

The **Defects liability period** is the period named in the Contract Data and calculated from the Completion Date.

The **Employer** is the party who will employ the Contractor to carry out the Works.

Equipment is the Contractor's machinery and vehicles brought temporarily to the Site to construct the Works.

The **Initial Contract price** is the Contract Price listed in the Employer's Letter of Acceptance.

The **Intended Completion Date** is the date on which it is intended that the Contractor shall complete the Works. The Intended Completion Date is specified in the Contract Data. The Intended Completion Date may be revised only by the Employer by issuing an extension of time.

'Joint Venture' means an ad hoc association of firms that pool their resources and skills to undertake a large or complex contract in the role of "Contractor," with all firms (partners in the JV) being legally liable, jointly and severally, for the execution of the Contract in the event of a partner's withdrawal.

Materials are all supplies, including consumables, used by the contractor for incorporation in the Works.

Plant is any integral part of the Works which is to have a mechanical, electrical, electronic or chemical or biological function.

The **Site** is the area defined as such in the Contract Data.

Specification means the Specification of the Works included in the Contract and any modification or addition made or approved by the Employer.

The **Start Date** is given in the Contract Data. It is the date when the Contractor shall commence execution of the works. It does not necessarily coincide with any of the Site Possession Dates.

A Subcontractor is a person or corporate body who has a Contract with the Contractor to carry out a part of the work in the Contract which includes work on the Site.

A **Variation** is an instruction given by the Employer which varies the Works.

The **Works** are what the Contract requires the Contractor to construct, install, and turn over to the Employer, as defined in the Contract Data.

2. INTERPRETATION

2.1 In interpreting these Conditions of Contract, singular also means plural, male also means female or neuter, and the other way around. Headings have no significance. Words have their normal meaning under the language of the Contract unless specifically defined. The Employer will provide instructions clarifying queries about the Conditions of Contract.

2.2 The documents forming the Contract shall be interpreted in the following order of priority:

- (1) Agreement
- (2) Letter of Acceptance, notice to proceed with the works
- (3) Contractor's Tender
- (4) Contract Data
- (5) Conditions of Contract
- (6) Specifications
- (7) Drawings
- (8) Bill of quantities and
- (9) any other document listed in the Contract Data as forming part of the Contract.

3. LAW GOVERNING CONTRACT

3.1 The law governing the Contract is the Laws of India supplanted by the Karnataka Local Acts.

4. EMPLOYER'S DECISIONS

4.1 Except where otherwise specifically stated, the Employer will decide contractual matters between the Employer and the Contractor.

5. DELEGATION

5.1 The Employer may delegate any of his duties and responsibilities to other people after notifying the Contractor and may cancel any delegation after notifying the Contractor.

6. COMMUNICATIONS

6.1 Communications between parties which are referred to in the conditions are effective only when in writing. A notice shall be effective only when it is delivered (in terms of Indian Contract Act).

7. SUBCONTRACTING:

7.1 The Contractor may subcontract with the approval of the Employer but may not assign the Contract without the approval of the Employer in writing. Subcontracting does not alter the Contractor's obligations.

8. OTHER CONTRACTORS

8.1 The Contractor shall cooperate and share the Site with other contractors, public authorities, utilities, and the Employer.

9. PERSONNEL

9.1 The Contractor shall employ the technical personnel (of number and qualifications) as may be stipulated by K-RIDE from time to time during the execution of the work. The technical staff so employed shall be available at site as may be stipulated by the Employer.

9.2 If the Employer asks the Contractor to remove a person who is a member of the Contractor's staff or his work force stating the reasons, the Contractor shall ensure that the person leaves the Site within seven days and has no further connection with the work in the Contract.

10. EMPLOYER'S AND CONTRACTOR'S RISKS

10.1 The Employer carries the risks which this Contract states are Employer's risks, and the Contractor carries the risks which this Contract states are Contractor's risks.

11. EMPLOYER'S RISKS

11.1 The Employer is responsible for the excepted risks which are:

(a) Rebellion, riot commotion or disorder unless solely restricted to employees of the Contractor or his Sub Contractors arising from the conduct of the Works; or

(b) a cause due solely to the design of the Works, other than the Contractor's design; or

(i) could not have reasonably foreseen; or

(ii) could reasonably have foreseen, but against which he could not reasonably have taken at least one of the following measures;

(A) prevent loss or damage to physical property from occurring by taking appropriate measures or

(B) insure against such loss or damage

12. CONTRACTOR'S RISKS

- 12.1 All risks of loss of or damage to physical property and of personal injury and death which arise during and in consequence of the performance of the Contract other than the excepted risks are the responsibility of the Contractor.

13. INSURANCE:

- 13.1 The Contractor shall prior to commencing the works, effect and thereafter maintain insurances, in the joint names of the Employer and the Contractor, (cover from the first working day after the Start Date to the end of Defects Liability Period), in the amounts stated in the Contract Data:

- (a) for loss of or damage to the Works, Plants and Materials and the Contractor's equipment;
- (b) for liability of both Parties for loss, damage, death and injury to third parties or their property arising out of the Contractor's performance of the Contract including the Contractor's liability for damage to the Employer's property other than the Works and
- (c) for liability of both Parties and of any Employer's representative for death and injury to the Contractor's personnel except to the extent that liability arises from the negligence of the Employer, any Employer's representative or their Employees.

- 13.2 Policies and certificates for insurance shall be delivered by the Contractor to the Employer for his approval before the Start Date. All such insurance shall provide for compensation to be payable to rectify the loss or damage incurred. All payments received from insurers relating to loss or damage shall be held jointly by the Parties and used for the repair of the loss or damage or as compensation for loss or damage that is not to be repaired.

- 13.3 If the Contractor fails to effect or keep in force any of the insurances referred to in the previous sub-clauses or fails to provide satisfactory evidence, policies or receipts, the Employer may without prejudice to any other right or remedy, effect insurance for the cover relevant to such default and pay the premiums due and recover the same as a deduction from any other monies due to the Contractor. If no payments is due, the payment of the premiums shall be a debt due.

- 13.4 Alterations to the terms of an insurance shall not be made without the approval of the Employer.

- 13.5 Both Parties shall comply with any conditions of the insurance policies.

14. SITE INVESTIGATION REPORTS:

- 14.1 The Contractor, in preparing the tender, shall rely on any site investigation reports referred to in the Contract data, supplemented by any information available to the Tenderer.

15. QUERIES ABOUT THE CONTRACT DATA

- 15.1 The Employer will clarify queries on the Contract Data.

16. CONTRACTOR TO CONSTRUCT THE WORKS

- 16.1 The Contractor shall construct the Works in accordance with the Specification and Drawings.

17. THE WORKS TO BE COMPLETED BY THE INTENDED COMPLETION DATE

17.1 The Contractor may commence execution of the Works on the Start Date and shall carry out the Works in accordance with the program submitted by the Contractor, as updated with the approval of the Employer, and complete them by the Intended Completion Date.

18. APPROVAL BY THE EMPLOYER:

18.1 The Contractor shall submit Specification and drawings showing the proposed Temporary Works to the Employer, who is to approve them if they comply with the Specifications and Drawings.

18.2 The Contractor shall be responsible for the design of Temporary Works

18.3 The Employer's approval shall not alter the Contractor's responsibility for design of the Temporary Works.

18.4 The Contractor shall obtain approval of third parties to design of the temporary Works where required.

18.5 All Drawings prepared by the Contractor for the execution of the temporary or permanent Works, are subject to prior approval by the Employer before their use.

19. SAFETY

19.1 The Contractor shall be responsible for the safety of all activities on the Site.

20. DISCOVERIES

20.1 Anything of historical or other interest or of significant value unexpectedly discovered on the Site is the property of the Employer. The Contractor is to notify the Employer of such discoveries and carry out the Employer's instructions for dealing with them.

21. POSSESSION OF THE SITE

21.1 The Employer shall give possession of all parts of the Site to the Contractor progressively, If possession of a part is not given by the date stated in the Contract Data the Employer is deemed to have delayed the start of the relevant activities and this will be compensation event.

22. ACCESS TO THE SITE

22.1 The Contractor shall allow the Employer and any person authorized by the Employer access to the Site, to any place where work in connection with the Contract is being carried out or is intended to be carried out and to any place where materials or plant are being manufactured / fabricated / assembled for the works.

23. INSTRUCTIONS

23.1 The Contractor shall carry out all instructions of the Employer which comply with the applicable laws where the Site is located.

24 PROCEDURE FOR RESOLUTION OF DISPUTES:

- 24.1 If the Contractor is not satisfied with the decision taken by the Employer, the dispute shall be referred by either party to Arbitration within 30 days of the notification of the Employer's decision.
- 24.2 If neither party refers the dispute to Arbitration within the above 30 days, the Employer's decision will be final and binding.
- 24.3 The Arbitration shall be conducted in accordance with the arbitration procedure stated in the Special Conditions of Contract.

K-RIDE

B. TIME CONTROL

25. PROGRAM

- 25.1 Within the time stated in the Contract Data the Contractor shall submit to the Employer for approval a Program showing the general methods, arrangements, order, and timing for all the activities in the Works.
- 25.2 The Employer's approval of the Program shall not alter the Contractor's obligations. The Contractor may revise the Program and submit it to the Employer again at any time. A revised Program is to show the effect of Variations and Compensation Events.

26. EXTENSION OF THE INTENDED COMPLETION DATE

- 26.1 The Employer shall extend the Intended Completion Date if a Compensation Event occurs or a Variation is issued which makes it impossible for Completion to be achieved by the Intended Completion Date.
- 26.2 The Employer shall decide whether and by how much to extend the Intended Completion Date within 21 days of the Contractor asking the Employer for a decision upon the effect of a Compensation Event or Variation and submitting full supporting information.

27. DELAYS ORDERED BY THE EMPLOYER

- 27.1 The Employer may instruct the Contractor to delay the start or progress of any activity within the Works.

28. MANAGEMENT MEETINGS

- 28.1 The Employer may require the Contractor to attend a management meeting. The business of a management meeting shall be to review the progress achieved and the plans for remaining work.
- 28.2 The responsibility of the parties for actions to be taken is to be decided by the Employer either at the management meeting or after the management meeting and stated in writing to be distributed to all who attended the meeting.

C. QUALITY CONTROL

29. IDENTIFYING DEFECTS

- 29.1 The Employer shall check the Contractor's work and notify the Contractor of any Defects that are found. Such checking shall not affect the Contractor's responsibilities. The Employer may instruct the Contractor to search for a Defect and to uncover and test any work that the Employer considers may have a Defect.

30. TESTS

- 30.1 If the Employer instructs the Contractor to carry out a test not specified in the Specification to check whether any work has a Defect and the test shows that it does, the Contractor shall pay for the test and any samples. If there is no Defect the test shall be a Compensation Event.

31. CORRECTION OF DEFECTS

- 31.1 The Employer shall give notice to the Contractor of any Defects before the end of the Defects Liability Period, which begins at Completion and is defined in the Contract Data. The Defects Liability Period shall be extended for as long as Defects remain to be corrected.
- 31.2 Every time notice of a Defect is given, the Contractor shall correct the notified Defect within the length of time specified by the Employer's notice.

32. UNCORRECTED DEFECTS

- 32.1 If the Contractor has not corrected a Defect within the time specified in the Employer's notice, the Employer will assess the cost of having the Defect corrected, and the Contractor will pay this amount.

D. COST CONTROL

33. BILL OF QUANTITIES (BOQ)

- 33.1 The BOQ shall contain items for the construction, installation, testing, and commissioning work to be done by the Contractor.
- 33.2 The BOQ is used to calculate the Contract Price. The Contractor is paid for the quantity of the work done at the rate in the BOQ for each item.

34. VARIATIONS

- 34.1 The Employer shall have power to order the Contractor to do any or all of the following as considered necessary or advisable during the progress of the work by him
- (a) Increase or decrease of any item of work included in the Bill of Quantities (BOQ);
 - (b) Omit any item of work;
 - (c) Change the character or quality or kind of any item of work;
 - (d) Change the levels, lines, positions and dimensions of any part of the work;
 - (e) Execute additional items of work of any kind necessary for the completion of the works; and
 - (f) Change in any specified sequence, methods or timing of construction of any part of the work.
- 34.2 The Contractor shall be bound to carry out the work in accordance with any instructions in this connection, which may be given to him in writing by the Employer and such alteration shall not vitiate or invalidate the contract.
- 34.3 Variations shall not be made by the Contractor without an order in writing by the Employer, provided that no order in writing shall be required for increase or decrease in the quantity of an item appearing in the BOQ so long as the work executed conforms to the approved drawings.
- 34.4 The contractor shall not make any alteration and/ or modification of the works unless and until the Engineer instructs or gives consent to a variation.
- 34.5 If the construction and/ or manufacture documents or works are not in accordance with the contract, the rectification shall not constitute a variation.

35. PAYMENTS FOR VARIATIONS

- 35.1 For the details of payments for variation, please refer clause 35/CC of Section 7.

36. SUBMISSION OF BILLS FOR PAYMENT

- 36.1 The Contractor shall submit to the Employer monthly bills of the value of the work completed less the cumulative amount paid previously.
- 36.2 The Employer shall check the Contractor's bill and determine the value of the work executed which shall comprise of (i) value of the quantities of the items in the BOQ completed and (ii) valuation of Variations and Compensation Events.

36.3 The Employer may exclude any item paid in a previous bill or reduce the proportion of any item previously paid in the light of later information.

37. PAYMENTS

37.1 Payments shall be adjusted for deductions for advance payments other than recoveries in terms of contract and taxes, at source as applicable under law. The Employer shall pay the Contractor within 60 days of submission of bill. The Contractor shall be liable to pay liquidated damages for shortfall in progress.

37.2 Items of the Works for which no rate or price has been entered in will not be paid for by the Employer and shall be deemed covered by other rates and prices in the Contract.

38. COMPENSATION EVENTS:

38.1 The following are Compensation Events unless they are caused by the Contractor:

- (a) The Employer instructs the Contractor to uncover or to carry out additional tests upon work which is then found to have no Defects.
- (b) The Employer gives an instruction for dealing with an unforeseen condition, caused by the Employer, or additional work required for safety or other reasons.
- (c) The effect on the Contractor of any of the Employer's Risks.
- (d) Other Compensation Events listed in the Contract Data or mentioned in the Contract.

38.2 If a Compensation Event would cause additional cost or would prevent the work being completed before the Intended Completion Date, the Contract Price shall be increased and/or the Intended Completion Date is extended. The Employer shall decide whether and by how much the Contract Price shall be increased and whether and by how much the Intended Completion Date shall be extended.

38.3 As soon as information demonstrating the effect of each Compensation event upon the Contractor's forecast cost has been provided by the Contractor, it is to be assessed by the Employer and the Contract Price shall be adjusted accordingly. If the Contractor's forecast is deemed unreasonable, the Employer shall adjust the Contract Price based on Employer's own forecast. The Employer will assume that the Contractor will react competently and promptly to the event.

38.4 The Contractor shall not be entitled to compensation to the extent that the Employer's interests are adversely affected by the Contractor not having given early warning or not having cooperated with the Employer.

39. TAX

39.1 The rates quoted by the Contractor shall be deemed to be inclusive of the sales, GST and other taxes that the Contractor will have to pay for the performance of this Contract. The Employer will perform such duties in regard to the deduction of such taxes at source as per applicable law.

40. PRICE ADJUSTMENT: - DELETED

41. LIQUIDATED DAMAGES

- 41.1 The Contractor shall pay liquidated damages to the Employer at the rate per day stated in the Contract Data for each day that the Completion Date is later than the Intended Completion Date (for the whole of the works or the milestone as stated in the Contract Data). The total amount of liquidated damages shall not exceed the amount defined in the Contract Data. The Employer may deduct liquidated damages from payments due to the Contractor. Payment of liquidated damages does not affect the Contractor's liabilities.
- 41.2 If the Intended Completion Date is extended after liquidated damages have been paid, the Employer shall correct any overpayment of liquidated damages by the Contractor by adjusting the next payment of bill.

42. ADVANCE PAYMENTS:

- 42.1 The Employer shall make payment to the Contractor of the amounts stated in the Contract Data by the date stated in the Contract Data, against provision by the Contractor of an unconditional bank guarantee in a form acceptable to the Employer issued by a Nationalized/Scheduled Bank in amounts equal to the advance payment. The guarantee shall remain effective until the advance payment has been repaid, but the amount of the guarantee shall be progressively reduced by the amounts repaid by the Contractor. The advance payments shall be repaid with prevailing bank interest.
- 42.2 The Contractor is to use the advance payment only to pay for Mobilization expenses required specifically for execution of the Works. The Contractor shall demonstrate that advance payment has been used in this way by supplying copies of invoices or other documents to the Employer
- 42.3 The advance payment shall be repaid by deducting proportionate amounts from payments otherwise due to the Contractor, following the schedule of completed percentages of the Works on a payment basis. No account shall be taken of the advance payment or its repayment in assessing valuation of the work done, variations, price adjustments, compensation events or liquidated damages

43. SECURITIES:

- 43.1 The Performance Security (including additional security for unbalanced tenders) shall be provided to the Employer no later than the date specified in the Letter of Acceptance and shall be issued in an amount and form and type of instrument acceptable to the Employer. The Performance Security as indicated in the contract data shall be valid until a date 30 days from the date of expiry of Defects Liability Period and the additional security for unbalanced tenders shall be valid until a date 30 days from the date of issue of the certificate of completion.

44. COST OF REPAIRS:

- 44.1 Loss or damage to the Works or Materials to be incorporated in the Works between the Start Date and the end of the Defects Correction periods shall be remedied by the Contractor at the Contractor's cost if the loss or damage arises from the Contractor's acts or omissions.

E. FINISHING THE CONTRACT

45. COMPLETION

45.1 The Contractor shall request the Employer to issue a Certificate of Completion of the Works and the Employer will do so upon deciding that the Work is completed.

46. TAKING OVER

46.1 The Employer shall take over the Site and the Works within seven days of issuing a certificate of Completion.

47. FINAL ACCOUNT

47.1 The Contractor shall supply to the Employer a detailed account of the total amount that the Contractor considers payable under the Contract before the end of the Defects Liability Period. The Employer shall issue a Defect Liability Certificate and certify any final payment that is due to the Contractor within 90 days of receiving the Contractor's account if it is correct and complete. If it is not, the Employer shall issue within 90 days a schedule that states the scope of the corrections or additions that are necessary. If the Final Account is still unsatisfactory after it has been resubmitted, the Employer shall decide on the amount payable to the Contractor and make payment within 60 days of receiving the Contractor's revised account.

48. AS BUILT DRAWINGS AND /OR OPERATING AND MAINTENANCE MANUALS

48.1 If "As Built Drawings" (Completion Drawing) and/or operating and maintenance manuals are required, the Contractor shall supply them by the dates stated in the Contract Data.

48.2 If the Contractor does not supply the Drawings by the dates stated in the Contract Data, or they do not receive the Employer's approval, the Employer shall withhold the amount stated in the Contract Data from payments due to the Contractor.

49. TERMINATION

49.1 The Employer may terminate the Contract if the other party causes a fundamental breach of the Contract.

49.2 Fundamental breaches of Contract include, but shall not be limited to the following:

- (a) the Contractor stops work for 45 days when no stoppage of work is shown on the current Program and the stoppage has not been authorized by the Employer;
- (b) - "DELETED"-
- (c) The Contractor becomes bankrupt or goes into liquidation other than for a reconstruction or amalgamation;
- (d) - "DELETED"-

SECTION – 5: CONDITIONS OF CONTRACT(CC) AND SPECIAL CONDITIONS OF CONTRACT (SCC)

- (e) the Employer gives Notice that failure to correct a particular Defect is a fundamental breach of Contract and the Contractor fails to correct it within a reasonable period of time determined by the Employer;
- (f) the Contractor does not maintain a security which is required;
- (g) the Contractor has delayed the completion of works by the number of days for which the maximum amount of liquidated damages can be paid as defined in the Contract data; and
- (h) if the Contractor, in the judgment of the Employer has engaged in corrupt or fraudulent practices in competing for or in the executing the Contract.

For the purpose of this paragraph: “corrupt practice” means the offering, giving, receiving or soliciting of anything of value to influence the action of a public official in the procurement process or in contract execution. “Fraudulent practice” means a misrepresentation of facts in order to influence a procurement process or the execution of a contract to the detriment of the Borrower, and includes collusive practice among Tenderers (prior to or after Tender submission) designed to establish Tender prices at artificial non-competitive levels and to deprive the Borrower of the benefits of free and open competition.”

49.3 When either party to the Contract gives notice of a breach of contract to the Employer for a cause other than those listed under Sub Clause 49.2 above, the Employer shall decide whether the breach is fundamental or not.

49.4 Notwithstanding the above, the Employer may terminate the Contract for convenience.

49.5 If the Contract is terminated the Contractor shall stop work immediately, make the Site safe and secure and leave the Site as soon as reasonably possible.

50. PAYMENT UPON TERMINATION

50.1 If the Contract is terminated because of a fundamental breach of Contract by the Contractor, the Employer shall prepare bill for the value of the work done less advance payments received up to the date of the bill, less other recoveries due in terms of the contract, less taxes due to be deducted at source as per applicable law and less the percentage to apply to the work not completed as indicated in the Contract Data. Additional Liquidated Damages shall not apply. If the total amount due to the Employer exceeds any payment due to the Contractor, the difference shall be a debt payable to the Employer.

50.2 If the Contract is terminated at the Employer's convenience, the Employer shall prepare bill for the value of the work done, the reasonable cost of removal of Equipment, repatriation of the Contractor's personnel employed solely on the Works, and the Contractor's costs of protecting and securing the Works and less advance payments received up to the date of the certificate, less other recoveries due in terms of the contract, and less taxes due to be deducted at source as per applicable law and make payment accordingly.

51. PROPERTY

- 51.1 All materials on the Site, Plant, Equipment, Temporary Works and Works are deemed to be the property of the Employer, if the Contract is terminated because of a contractor's default.

52. RELEASE FROM PERFORMANCE

- 52.1 If the Contract is frustrated by any event entirely outside the control of either the Employer or the Contractor the Employer shall certify that the Contract has been frustrated. The Contractor shall make the Site safe and stop work as quickly as possible after receiving this certificate and shall be paid for all work carried out before receiving it and for any work carried out afterwards to which commitment was made.

K-RIDE

F. SPECIAL CONDITIONS OF CONTRACT

1. LABOUR :

The Contractor shall, unless otherwise provided in the Contract, make his own arrangements for the engagement of all staff and labour, local or other, and for their payment, housing, feeding and transport.

The Contractor shall, if required by the Employer, deliver to the Employer a return in detail, in such form and at such intervals as the Employer may prescribe, showing the staff and the numbers of the several classes of labour from time to time employed by the Contractor on the Site and such other information as the Employer may require.

2. COMPLIANCE WITH LABOUR REGULATIONS:

During continuance of the Contract, the Contractor and his sub-contractors shall abide at all times by all existing labour enactments and rules made there under, regulations, notifications and bye laws of the State or Central Government or local authority and any other labour law (including rules), regulations, bye laws that may be passed or notification that may be issued under any labour law in future either by the State or the Central Government or the local authority. The Contractor shall keep the Employer indemnified in case any action is taken against the Employer by the competent authority on account of contravention of any of the provisions of any Act or rules made there under, regulations or notifications including amendments. If the Employer is caused to pay or reimburse, such amounts as may be necessary to cause or observe, or for non-observance of the provisions stipulated in the notifications/bye laws/Acts/Rules/regulations including amendments, if any, on the part of the Contractor, Employer shall have the right to deduct any money due to the Contractor including his amount of security deposit. The Employer shall also have right to recover from the Contractor any sum required or estimated to be required for making good the loss or damage suffered by the Employer.

The employees of the Contractor and the Sub-Contractor in no case shall be treated as the employees of the Employer at any point of time.

3. PROTECTION OF ENVIRONMENT:

The Contractor shall take all reasonable steps to protect the environment on and off the Site and to avoid damage or nuisance to persons or to property of the public or others resulting from pollution, noise or other causes arising as a consequence of his methods of operation. During continuance of the contract, the Contractor and his sub-contractors shall abide at all times by all existing enactments on environmental protection and rules made there under, regulations, notifications and bye-laws of the State or Central Government, or local authorities and any other law, bye-law, regulations that may be passed or notification that may be issued in this respect in future by the State or Central Government or the local authority.

4. CLAIMS, DISPUTES AND ARBITRATION

4.1 Contractor's Claims

If the Contractor considers himself to be entitled to any extension of the Time for Completion and/or any additional payment, under any Clause of these Conditions or otherwise in connection with the Contract, the Contractor shall give notice to the Engineer, describing the event or

SECTION – 5: CONDITIONS OF CONTRACT(CC) AND SPECIAL CONDITIONS OF CONTRACT (SCC)

circumstance giving rise to the claim. The notice shall be given as soon as practicable, and not later than 28 days after the Contractor became aware, or should have become aware, of the event or circumstance.

If the Contractor fails to give notice of a claim within such period of 28 days, the Time for Completion shall not be extended, the Contractor shall not be entitled to additional payment, and the Employer shall be discharged from all liability in connection with the claim. Otherwise, the following provisions of this Sub-Clause shall apply.

The Contractor shall also submit any other notices which are required by the Contract, and supporting particulars for the claim, all as relevant to such event or circumstance.

The Contractor shall keep such contemporary records as may be necessary to substantiate any claim, either on the Site or at another location acceptable to the Engineer. Without admitting the Employer's liability, the Engineer may, after receiving any notice under this Sub-Clause, monitor the record-keeping and/or instruct the Contractor to keep and provide further contemporary records. The Contractor shall permit the Engineer to inspect all these records, and shall (if instructed) submit copies to the Engineer.

Within 45 days after the Contractor became aware (or should have become aware) of the event or circumstance giving rise to the claim, or within such other period as may be proposed by the Contractor and approved by the Engineer, the Contractor shall send to the Engineer a fully detailed claim which includes full supporting particulars of the basis of the claim and of the extension of time and/or additional payment claimed. If the event or circumstance giving rise to the claim has a continuing effect:

- (a) this fully detailed claim shall be considered as interim;
- (b) the Contractor shall send further interim claims at monthly intervals, giving the accumulated delay and/or amount claimed, and such further particulars as the Engineer may reasonably require; and
- (c) the Contractor shall send a final claim within 28 days after the end of the effects resulting from the event or circumstance, or within such other period as may be proposed by the Contractor and approved by the Engineer.

Within 45 days after receiving a claim or any further particulars supporting a previous claim, or within such other period as may be proposed by the Engineer and approved by the Contractor, the Engineer shall respond with approval, or with disapproval and detailed comments. He may also request any necessary further particulars, but shall nevertheless give his response on the principles of the claim within such fixed period of time.

Each Payment Certificate shall include such amounts for any claim as have been reasonably substantiated as due under the relevant provision of the Contract. Unless and until the particulars supplied are sufficient to substantiate the whole of the claim, the Contractor shall only be entitled to payment for such part of the claim as he has been able to substantiate.

The Engineer shall proceed in accordance with Sub-Clause: [Determinations] to agree or determine (i) the extension (if any) of the Time for Completion (before or after its expiry) in accordance with Sub-Clause: [Extension of Time for Completion], and/or (ii) the additional payment (if any) to which the Contractor is entitled under the Contract.

The requirements of this Sub-Clause are in addition to those of any other Sub-Clause which may apply to a claim. If the Contractor fails to comply with this or another Sub-Clause in relation to any claim, any extension of time and/or additional payment shall take account of the extent

(if any) to which the failure has prevented or prejudiced proper investigation of the claim, unless the claim is excluded under the second paragraph of this Sub-Clause.

4.2 Amicable Settlement

In case any dispute between the Engineer and the Contractor for which claim has already been made by the contractor, remains unresolved, the Contractor shall, then, give notice of dissatisfaction and intention to commence arbitration to the Employer duly specifying the subject of the dispute or difference as also the amount of claim item wise. The Parties shall make attempts to settle the dispute amicably before the commencement of arbitration as per procedure set by K-RIDE. However, unless both Parties agree otherwise, demand for arbitration may be made by the Contractor after ninety days from the day on which a notice of dissatisfaction and intention to commence arbitration was given, even if no attempt at amicable settlement has been made.

Procedure for Amicable Settlement in contracts

1. Amicable Settlement Committee at senior management level shall make an attempt to resolve the issues/disputes within 90 days of request by the Contractor.
2. The committee shall comprise of the following: -
 - (i) JGM /K-RIDE directly in-charge of the project;
 - (ii) Concerned finance officer, and
 - (iii) JGM /K-RIDE (in the same order) directly in-charge of the project of other discipline(s) in case the issues involve other discipline(s) of the engineering
3. Whenever the Contractor submits a request for amicable settlement, MD/K-RIDE should forward the same to concerned JGM /K-RIDE (in the same order) directly in-charge of the project. JGM /K-RIDE on receipt of the same shall issue a note to the concerned finance officer and concerned JGM/K-RIDE of other discipline in case the issues involved other discipline(s) of engineering, about the request for amicable settlement to be dealt by them and fix a date in consultation with them for a hearing. The date should then be communicated to the MD/K-RIDE, JGM/ /K-RIDE of other department (if the issues involved their department) and Contractor for presenting their case before the Amicable Settlement Committee.
4. This being an additional workload like arbitration, the Committee members shall be paid fee by K-RIDE at the rates payable to the Arbitrators of K-RIDE.

4.3 Arbitration

Any dispute, in respect of which amicable settlement has not been reached, arising between the Employer and the Domestic or Foreign Contractor related to any matter arising out of or connected with this contract, then the contractor shall be entitled to demand in writing that the dispute or difference be referred to arbitration.

Only such dispute(s) or difference(s) in respect of which the demand had been made for amicable settlement under GCC 4.2 but could not be settled, shall be referred to arbitration subject to the condition that cumulative amount of claims in the Contract is not exceeding 20% of the Contract price. In case the cumulative amount of claims exceeds 20% of the Contract price, arbitration clause will not be applicable.

The Arbitration proceedings shall commence from the day, a written and duly quantified demand for arbitration is received by Managing Director, Rail Infrastructure Development Company (Karnataka) Limited, Bangalore /K-RIDE).

The disputes so referred to arbitration shall be settled in accordance with the Indian Arbitration & Conciliation Act, 1996 and any statutory modification or re-enactment thereof.

Any dispute or difference or claim arising out of, or in connection with, or relating to the present contract or the breach, termination or invalidity thereof shall be referred and settled under the Arbitration Centre – Karnataka (Domestic and International) Rules 2012, by one or more arbitrators appointed in accordance with its rules.

Further, it is agreed between the Parties as under.

4.3.1 Number of Arbitrators: The arbitral tribunal shall consist of three arbitrators.

4.3.2 Procedure for Appointment of Arbitrators: The arbitrators shall be appointed as per following procedure:

- (a) The Contractor, while invoking demand for arbitration, shall submit to MD/K-RIDE, claims duly quantified along with name and contact details of his nominee arbitrator. Thereafter, the Employer will nominate his nominee arbitrator within a period of 30 days from receipt of such demand from the Contractor and will issue letter of appointment to both the arbitrators appointed by the Parties with a copy of the same given to the Contractor.
- (b) The third Arbitrator shall be chosen by the two Arbitrators so appointed by the Parties and shall act as Presiding Arbitrator. In case of failure of the two Arbitrators appointed by the Parties to reach a consensus within a period of 30 days from the appointment of the said Arbitrators, then, upon the request of either or both Parties, the Presiding Arbitrator shall be appointed by the Managing Director, Rail Infrastructure Development Company (Karnataka) Limited, Bangalore.
- (c) If one or more of the arbitrators appointed as above refuses to act as arbitrator, withdraws from his office as arbitrator, or vacates his/their office/offices or is/are unable or unwilling to perform his functions as arbitrator for any reason whatsoever or dies or in the opinion of the concerned GM/K-RIDE fails to act without undue delay, the MD/K-RIDE shall appoint new arbitrator/arbitrators to act in his/their place except in case of new Presiding Arbitrator who shall be chosen following the same procedure as mentioned in para (b) above. Such re-constituted Tribunal may, at its discretion, proceed with the reference from the stage at which it was left by the previous arbitrator(s).

4.3.3 Qualification and Experience of Arbitrators (to be appointed as per sub-clause 4.3.2 above): The contract being of specialized nature requiring knowledge and experience of dealing with construction contracts, the arbitrators to be appointed shall have minimum qualification and experience as under:

Arbitrator shall be;

a working/retired officer (not below E-9 grade and above in a PSU with which K-RIDE has no business relationship) of any discipline of Engineering or Accounts/Finance department, having

experience in Contract Management of construction contracts; or a retired officer (retired not below the HAG level) of any Engineering/Accounts Services of Central Government, having experience in Contract Management of construction contracts; or a retired officer who should have retired more than 3 years previously from the date of appointment as Arbitrator (retired not below E-9 grade in K-RIDE or a PSU with which K-RIDE has a business relationship) of any Engineering discipline or Accounts department, having experience in Contract Management of construction contracts.

- 4.3.4** No person other than the persons appointed as per above procedure and having above qualification and experience shall act as Arbitrator. In case any person having the qualification and experience other than that mentioned above is nominated as arbitrator, the arbitration clause shall cease to exist and shall not be applicable.

No new claim, except as otherwise mutually agreed by the Parties, shall be added during proceedings by either Party. However, a Party may amend or supplement the original claim or defence thereof during the course of arbitration proceedings subject to acceptance by Tribunal having due regard to the delay in making it.

- 4.3.5** Neither Party shall be limited in the proceedings before such arbitrators to the evidence nor the arguments previously put before during amicable settlement.

- 4.3.6** The reference to arbitration may proceed, notwithstanding that the Works shall not then be or be alleged to be complete, provided always that the obligations of the Employer, the Engineer and the Contractor shall not be altered by the reason of the arbitration being conducted during the progress of the Works. Neither Party shall be entitled to suspend the Works, nor shall payment to the Contractor be withheld on account of such proceedings

- 4.3.7** If the contractor(s) does/do not prefer his/their specific and final claims in writing, within a period of 90 days of receiving the intimation from the Employer/Engineer that the final bill is ready for signature of the Contractor(s), he/they will be deemed to have waived his/their claim(s) and the Employer shall be discharged and released of all liabilities under the contract in respect of these claims.

- 4.3.8** Arbitration proceedings shall be held at Bangalore, India or at a place where JGM(Elc)/K-RIDE's (dealing the contract) office is located, and the language of the arbitration proceedings and that of all documents and communications between the Parties shall be in English.

- 4.3.9** The Arbitral Tribunal should record day to day proceedings. The proceedings shall normally be conducted on the basis of documents and written statements.

All arbitration awards shall be in writing and shall state item wise, the sum and detailed reasons upon which it is based.

- 4.3.10** Any ruling on award shall be made by a majority of members of Arbitral Tribunal. In the absence of such a majority, the views of the Presiding Arbitrator shall prevail.

A Party may apply for correction of any computational errors, any typographical or clerical errors or any other error of similar nature occurring in the award of a tribunal and interpretation of specific point of award to tribunal within 60 days of the receipt of award.

A Party may apply to Arbitral tribunal within 60 days of receipt of award to make an additional award as to claims presented in the arbitral proceedings but omitted from the arbitral award.

- 4.3.11** Where the Arbitral award is for the payment of money, no interest shall be payable on whole or any part of the money for any period till the date on which the award is made.
- 4.3.12** The fees and other charges of the conciliator/arbitrators shall be as per the fee structure fixed by the Employer as amended from time to time irrespective of the fact whether the Arbitrator(s) is/are appointed by the Parties or by the Court of law unless specifically directed by Hon'ble Court otherwise on the matter, and shall be shared equally by the Employer and the Contractor. However, the expenses incurred by each Party in connection with the preparation, presentation will be borne by itself.
- 4.3.13** Performance under the contract shall continue during the arbitration proceedings and payments due the Contractor by the Employer shall not be withheld, unless they are the subject matter of the arbitration proceeding.

4.3.14 Excepted matters:

The following are the list of excepted matters in arbitration.

- a. Assistance by Employer for the Stores to be obtained by the Contractor.
- b. Illegal Gratification.
- c. Meaning and intent of specifications and Drawings.
- d. Rates for Non-tendered items of works.
- e. Signing of "No claim Certificate"
- f. Measurement of works.
- g. Provisions of Payment of Wages Act 1936.
- h. Provisions of Contract Labour (Regulation and Abolition) Act, 1970.
- i. Provisions of Employees Compensation Act 1923.
- j. Provisions of Mines Act 1952.
- k. Right of Employer to determine the Contract
- l. Payment on determination of Contract by Employer.

5. JURISDICTION OF COURTS

The Contract Agreement shall be subject to exclusive jurisdiction of Courts as indicated in the Contract Data. **The Jurisdiction of Courts is Bengaluru, Karnataka**

6. If K-RIDE wishes to engage third party consultants for quality control assessment, apart from the K-RIDE quality control and field tests, the Contractor should co-operate with both Quality control authorities and the third party.
7. Defect liability period will be ONE Year from the date of commercial operations of the Section/Corridor.
8. Royalty Charges shall be recovered as per the prevailing rates by the Department of Mines & Geology, if not paid by the Contractor.

SECTION – 5: CONDITIONS OF CONTRACT(CC) AND SPECIAL CONDITIONS OF CONTRACT (SCC)

9. As per GO No. CD/300/ LET/ 2006: Dated 18-12-2007, 1% cess will be deducted from the bill as per labour welfare act.
10. All the works are to be carried out as per the Standard specification Issued from time to time.

K-RIDE

SECTION – 6

CONTRACT DATA

INDEX

Table of Contents

SL NO.	DESCRIPTION	PAGE NO.
1	MILE STONE DATES	125
2	INSURANCE REQUIREMENT	126
3	PRICE ADJUSTMENT	126

K-RIDE

SECTION 6: CONTRACT DATA

Items marked "N/A" do not apply in this Contract.

The following documents are also part of the Contract:

Clause Reference

- The Methodology and Program of Construction (25 of GCC)
- Site Investigation Reports (14 of GCC)
- The Schedule of Key and Critical Equipment to be deployed on the work as per agreed program of construction. (3.3 of ITT, 25 GCC)

The Employer is:

Name: K-RIDE

(1.1 of GCC)

Address: K-RIDE, Bangalore

Name of authorized Representative: K-RIDE

The name and identification number of the Contract: **“SHIFTING OF ELECTRICAL UTILITIES INFRINGING PROPOSED CORRIDOR-2 OF BENGALURU SUBURBAN RAIL PROJECT BETWEEN LOTTEGOLLAHALLI TO YESWANTPUR OF CHIKKBANAVARA TO BAIYYAPPANAHALLI SECTION”**.

Tender No: K-RIDE/BSRP/17/2022, Dated:10.02.2023

Description of Work:

The tendered work is part of the Corridor-2 of BSRP project between **CHIKKBANAVARA-BAIYYAPPANAHALLI**. It is proposed to shift/modify the power lines which are infringing to proposed Corridor -2 i.e., from CHIKKBANAVARA TO BAIYYAPPANAHALLI SECTION. The shifting/modification work majorly involves **Lottegollahalli to Yeswantapur section**. However, covers any other utility shifting / modifications required for construction of Corridor -2 as advised by Engineer-in-charge from time to time. And it can be started immediately in order to give the working clearance for the corridor construction works.

The start date shall be the date of issue of notice to proceed with the work. [1.1 of GCC]

The Intended Completion Date for the whole of the Works is
12 MONTHS INCLUDING MONSOON with the following milestones - [17, 26 of GCC]

MILESTONE DATES:

Physical works to be completed as per Milestones

Mohan Kumar Nagar Road, Gokula Extension C6-Sub Division, Mattikere.

Key Dates No. (Mile stone)	Description of stage (Physical works to be completed)	Period from the date of issue of notice to proceed with the work
KD 1	Joint inspections of site/locations along with KRIDE officials	3
KD 2	Processing of case papers for consent of modification of BESCO power lines.	7
KD-3	Start modification work	21
KD 4	Completion of modification work	150
KD 5	Arranging EIG inspection wherever required.	155
KD 6	Obtaining EIG approval and charging of power line and handing over to BESCO authorities	175

Lottegollahalli station surroundings, C6-Sub Division, Yeshwantpur.

Key Dates No. (Mile stone)	Description of stage (Physical works to be completed)	Period from the date of issue of notice to proceed with the work
KD 1	Joint inspections of site/locations along with KRIDE officials	3
KD 2	Processing of case papers for consent of modification of BESCO power lines.	7
KD-3	Start modification work	15
KD 4	Completion of modification work	60
KD 5	Arranging EIG inspection wherever required.	70
KD 6	Obtaining EIG approval and charging of power line and handing over to BESCO authorities	90

The work front/ Possession of site will be provided progressively.

The site is located in Bangalore and the alignment is from Lottegollahalli to Yeshwanthapur

The Defect Liability period is One year.

The insurance requirement is as below.

SI No.	Type of Cover	Minimum cover for Insurance ³⁶
(i)	Works and Plant and materials	Not Applicable
(ii)	Loss or damage to equipment	Full replacement cost
(iii)	Loss or damage to property of Third Party	Full replacement cost
(iv)	Personal injury or death insurance (a) for Third Party	In accordance with the statutory requirements applicable to Karnataka.
	(b) for Contractor's employees or labour	In accordance with the statutory requirements applicable to Karnataka.

PRICE ADJUSTMENT:

CHANGE IN COSTS - PRICE ADJUSTMENT

PRICE ADJUSTMENT CLAUSE FOR WORKS CONTRACTS -DELETED

The liquidated damages for the whole of the works are

The liquidity damages for each Key dates/milestone have been indicated at Annexure-1 of Works/Employers requirement section for not achieving the Key Date/ Milestone for each Day. The maximum amount of liquidated damages for the whole of the works is Ten percent of final contract price: [GCC 41]

For the purpose of this clause, the contract value of the works shall be taken as value of work as per contract agreement including any supplementary work order/contract agreement issued. Provided also. that the total amount of liquidated damages under this condition shall not exceed 10% of the contract value or of the total value of the item or groups of items of work for which a separated distinct completion period is specified in the contract.

Sl.no	Damage & Delay	Rate of penalty
1	For delay in achieving physical/Financial target as per the agreed programme	0.01% of contract value for each week or part of the week.

Sl.no	Duration of extension of time under Clause 41 of GCC	Rate of Penalty
1	Up to Twenty percent of original period of completion including period of extension of DOC granted under Section 41 of GCC	As decided by Engineer, between 0.01% to 0.10% of contract value for each week or part of the week
2	Above Twenty percent but upto Thirty percent of original period of completion including period of extension of DOC granted under Section 41 of GCC	0.20% of contract value for each week or part of the week

3	Above Thirty percent but upto Forty percent of original period of completion including period of extension of DOC granted under Section 41 of GCC	0.30% of contract value for each week or part of the week
4	Above Forty percent of original period of completion including period of extension of DOC granted under Section 41 of GCC	0.50% of contract value for each week or part of the week

Provided further, that if the employer is not satisfied that the works can be completed by the Contractor and in the event of failure on the part of the contractor to complete the work within further extension of time allowed as aforesaid, the employer shall be entitled without prejudice to any other right or remedy available in that behalf.

The amounts of the advance payment are : [GCC 42]

Nature of Advance	Amount Rs.	Conditions to be fulfilled
Mobilization	5% of the contract price (In Two Installments)	On submission of unconditional bank guarantee (further details are in Particular conditions of contract)

(The advance payment will be paid to the contractor no later than 30 days after fulfillment of the above condition.)

Repayment of advance payment for mobilization:

The recovery of the Mobilization and Plant and Machinery Advances shall be made from each bill in equal monthly instalments commencing after 15% of contract value is billed and recovery to be completed within 85% of the contract value and the recovery shall be made at the rate 10% of the amount the Interim payment certificate until such time as loan has been repaid, always provided that the loan shall be completely repaid prior to the expiry of the original time for completion pursuant to Clauses 17 and 26.

The date by which “as-erected” drawings (in suitable scale) in 5 sets are required is within 30 days of issue of certificate of completion of Whole or Section of the Work as the case may be. [GCC 48]

The amount to be withheld for failing to supply “as erected” drawings Rs. 25,000 for each location

The following events shall also be fundamental breach of the contract: [GCC 49.2]

The contractor has contravened Sub-clause 7.1 and Clause 9 of Condition of contract.

The percentage to apply to the value of the work not completed representing the Employer's 30% [GCC 50.1]

Jurisdiction of Courts :

Jurisdiction of Courts is Bengaluru, Karnataka.

SECTION-7
**PARTICULAR CONDITIONS OF
CONTRACT (PCC)**

BLANK PAGE

K-RIDE

PARTICULAR CONDITIONS OF CONTRACT (PCC)

The following Particular Conditions of Contract (PCC) shall supplement the Conditions of Contract (CC)/GCC/SCC/Contract Data. Whenever there is a conflict, the provisions herein shall prevail over those in the CC/GCC/SCC/Contract Data. The conditions indicated in PCC will be on priority as compared to the conditions of CC/GCC/SCC/Contract Data.

CC/SCC REFERENCE CLAUSE	DESCRIPTION
Clause-1/CC Definitions	<p>The following paras are added to the Existing CC Clauses.</p> <p>“Contract Agreement” The Parties shall enter into a Contract Agreement within 28 days after the Contractor receives the Letter of Acceptance, unless they agree otherwise.</p> <p>“Letter of Acceptance” means the letter of formal acceptance, signed by the Employer, of the Letter of Bid, including any annexed memoranda comprising agreements between and signed by both Parties. If there is no such letter of acceptance, the expression “Letter of Acceptance” means the Contract Agreement and the date of issuing or receiving the Letter of Acceptance means the date of signing the Contract Agreement.</p> <p>“Letter of Bid” means the document entitled letter of bid, which was completed by the Contractor and includes the signed offer to the Employer for the Works.</p> <p>“Drawings” means the drawings of the Works, as included in the Contract, and any additional and modified drawings issued by (or on behalf of) the Employer in accordance with the Contract.</p> <p>“Schedules” means the document(s) entitled schedules, completed by the Contractor and submitted with the Letter of Bid, as included in the Contract. Such document may include the Bill of Quantities, data, lists, and schedules of rates and/or prices.</p> <p>“Bid/Tender” means the Letter of Technical Bid and Letter of Price Bid and all other documents which the Contractor submitted with the Letter of Technical Bid and Letter of Price Bid, as included in the Contract.</p> <p>“Employer’s Requirements” means the document entitled ‘Employer’s Requirements’ as part of Works Requirements and as included in the Contract, and any additions and modifications to such document in accordance with the Contract. Such document specifies the purpose, scope, and/or design and/or other technical criteria, for the works.</p> <p>Parties and Persons</p> <p>“Party” means the Employer or the Contractor, as the context requires.</p> <p>“Engineer” means the person nominated by the Employer to act as the Engineer for the purposes of the Contract and named in the Contract Data, or other person appointed from time to time by the Employer and notified to the Contractor under New-Clause 3.4 [Replacement of the Engineer]. The person nominated to act as an engineer may be an employee of Rail Infrastructure Development Company (Karnataka) Ltd (K-RIDE) or an employee of a Project Management Consultancy firm engaged by K-RIDE for project management as per the discretion of the Employer.</p> <p>“Contractor’s Representative” means the person named by the Contractor in the Contract or appointed from time to time by the Contractor under New-Clause 4.3 [Contractor’s Representative], who acts on behalf of the Contractor.</p>

“Employer’s Representative” means the person named by the Employer in the Contract or appointed from time to time by the Employer who acts on behalf of the Employer.

“Employer’s Personnel” means the Engineer, the assistants referred to in New-Clause 3.2 [Delegation by the Engineer] and all other staff, labour and other employees of the Engineer and of the Employer; and any other personnel notified to the Contractor, by the Employer or the Engineer, as Employer’s Personnel.

“Contractor’s Personnel” means the Contractor’s Representative and all personnel whom the Contractor utilises on Site, who may include the staff, labour and other employees of the Contractor and of each Subcontractor; and any other personnel assisting the Contractor in the execution of the Works.

“Base Date” means the date 28 days prior to the deadline for submission of bids.

“Tests on Completion” means the tests which are specified in the Contract or agreed by both Parties or instructed as a Variation, and which are carried out under Clause 30 [Tests on Completion] before the Works or a Section (as the case may be) are taken over by the Employer.

“Day” means any (working or non-working) calendar day from 00:00 hrs. to 24:00 hrs.

“Time Periods” Any reference to time period commencing “from” the specified day or date “till” or “until” a specified day shall include both such days.

Any reference to **“Time”** shall be according to Indian Standard Time (IST).

Money and Payments

“Accepted Contract Amount” means the amount accepted in the Letter of Acceptance for the execution and completion of the Works and the remedying of any defects. In the Letter of Acceptance, the Accepted Contract Amount shall have two components i.e. (i) the base amount excluding GST (ii) GST component (calculated at the rate for works contract service as per GST Laws).

“Cost” means all expenditure reasonably incurred (or to be incurred) by the Contractor, whether on or off the Site, including overhead and similar charges, but does not include profit.

“Final Statement” means the statement defined in Sub-Clause 37.12 [Application for Final Payment Certificate].

“Foreign Currency” means a currency in which part (or all) of the Contract Price is payable, but not the Local Currency.

“Local Currency” means the currency in Indian Rupees.

“Statement” means a statement submitted by the Contractor as part of an application, under Clause 37 and 40 [Contract Price and Payment], for a payment certificate

Works and Goods

“Contractor’s Equipment” means all apparatus, machinery, vehicles and other things required for the execution and completion of the Works and the remedying of any defects. However, Contractor’s Equipment excludes Temporary Works, Employer’s Equipment (if any), Plant, Materials and any other things intended to form or forming part of the Permanent Works.

“Goods” means Contractor’s Equipment, Materials, Plant and Temporary Works, or any of them as appropriate.

“Permanent Works” means the shifting of electrical utilities infringing to proposed track doubling work between Yesvantpur to Hosur and other misc. General service works to be executed by the Contractor under the Contract.

	<p>“Section” means a part of the Works specified in the Contract Data as a Section (if any).</p> <p>“Temporary Works” means all temporary works of every kind (other than Contractor’s Equipment) required on Site for the execution and completion of the shifting and modification works in the existing system and the remedying of any defects.</p> <p>Other Definitions</p> <p>“Contractor’s Documents” means the calculations, computer programs and other software, drawings, manuals, models and other documents of a technical nature (if any) supplied by the Contractor under the Contract.</p> <p>“Country” means India, the country in which the Site (or most of it) is located, where the Permanent Works are to be executed.</p> <p>“Employer’s Equipment” means the apparatus, machinery and vehicles (if any) made available by the Employer for the use of the Contractor in the execution of the Works, as stated in the Specification; but does not include Plant which has not been taken over by the Employer.</p> <p>“Laws” means all national (or state) legislation, statutes, ordinances and other laws, and regulations and by-laws of any legally constituted public authority.</p> <p>“Site” means the places where the Utility Shifting Works are to be executed and to which Plant and Materials are to be delivered, and any other places as may be specified in the Contract as forming part of the Site.</p> <p>“Unforeseeable” means not reasonably foreseeable and against which adequate preventive precautions could not reasonably be taken by an experienced contractor by the date for submission of the Bid.</p> <p>“Railway” means a railway, or any portion of a railway for public carriage of passengers and goods as defined in the Railways ACT 1989. Any reference to railway means the Indian Railways and the respective Zonal Railway</p>
<p>Clause-1/CC</p>	<p>The following paras are added to the Existing CC Clauses.</p> <p>Employers Name and Address: K-RIDE (Rail Infrastructure Development Company (Karnataka) Limited) (A Joint venture of GoK and MoR) #8 , 1st Floor, Samparka Soudha, Dr. Rajkumar Road, Opposite Orion Mall Rajaji Nagar 1st Block Bangalore – 560010 Tele: +91 6366430945</p> <p>Employers Representative and address: Joint General Manager/Electrical K-RIDE, K-RIDE (Rail Infrastructure Development Company (Karnataka) Limited) #8, 1st Floor, Samparka Soudha, Dr. Rajkumar Road, Opposite Orion Mall Rajaji Nagar 1st Block Bangalore – 560010 Tele: +91 6366430945 E – Mail: electrical.kride@gmail.com</p>

<p>Clause -2.1/CC Interpretation.</p>	<p>The following paras are added to the Existing CC Clauses.</p> <p>(a) provisions including the word “agree,” “agreed” or “agreement” require the agreement to be recorded in writing;</p> <p>(b) “written” or “in writing” means hand-written, type-written, printed or electronically made, and resulting in a permanent record; and</p> <p>(c) the word “tender” is synonymous with “bid”, and “tenderer” with “bidder” and the words “tender documents” with “bidding documents”</p>
<p>Clause-2.2/CC. Priority of Documents</p>	<p>Replace the existing sub clause 2.2 of CC</p> <p>The documents forming the Contract are to be taken as mutually explanatory of one another. For the purposes of interpretation, the priority of the documents shall be in accordance with the following sequence:</p> <ol style="list-style-type: none"> 1. Contract Agreement (if any), 2. Letter of Acceptance, notice to proceed to works, 3. Letter of bid/Contractor tender, 4. Addendum/Corrigendum including Reply to pre bid queries, 5. Schedules (including Priced Bill of Quantities), 6. Particular Conditions of Contract, 7. Conditions of Contract/SCC and Contract Data 8. Works/Employer’s Requirements, 9. Technical Specifications, 10. Drawings, 11. any other documents forming part of the Contract. <p>If an ambiguity or discrepancy is found in the documents, the Engineer shall issue necessary clarification or instruction.</p>
<p>Clause-6.1/CC, Communications</p>	<p>The following para is added to the existing CC clause:</p> <p>Wherever these Conditions provide for the giving or issuing of approvals, certificates, consents, determinations, notices, requests and discharges, these communications shall be: in writing and delivered by hand (against receipt), sent by mail or courier, or transmitted using any of the agreed systems of electronic transmission as stated in the Contract Data; and delivered, sent or transmitted to the address for the recipient’s communications as stated in the Contract Data.</p>
<p>Clause- 7/CC</p>	<p>The following paras are added to the Existing CC Clauses.</p> <p>7.1 Definition of nominated Subcontractor</p> <p>In the Contract, “nominated Subcontractor” means a Subcontractor:</p> <p>(a) who is stated in the Contract as being a nominated Subcontractor, or</p> <p>(b) whom the Engineer, under Clause 7/CC [Sub-contracting], instructs the Contractor to employ as a Subcontractor.</p>

Sub-contractors

The Contractor shall not subcontract the whole of the Works. The Contractor shall be responsible for the acts or defaults of any Subcontractor, his agents or employees, as if they were the acts or defaults of the Contractor.

Unless otherwise stated in the Conditions of Contract:

- (a) The Contractor shall not be required to obtain consent to suppliers solely of Materials, or to a subcontract for which the Subcontractor is named in the Contract or as specifically provided in the Contract data or value of any sub-contract for Works, provided that such works are not for the key activities.
- (b) The prior consent of the Engineer shall be obtained to other proposed Subcontractors and/or suppliers. While submitting his proposal in this regard, the Contractor shall ensure that;
 - (i) Total value of Works requiring such consent for subcontracting shall not be more than 50% (fifty per cent) of the Contract Price;
 - (ii) The proposed subcontractor must have executed works of 40% of value of the proposed subcontract through a single contract during last seven years; and
 - (iii) No banning/blacklisting/declaration as poor performer by K-RIDE is in force on the proposed subcontractor (on the date of grant of consent by the Engineer);
 - (iv) No contract of the proposed subcontractor has been terminated by K-RIDE during the last two years (to be reckoned from the date of grant of consent by the Engineer);
 - (v) The Contractor shall submit the proposal for subcontracting with the name, particulars and the relevant experience of the proposed subcontractor.
- (c) The Contractor shall give the Engineer not less than 28 days' notice of the intended date of the commencement of each Subcontractor's work, and of the commencement of such work on the Site;
- (d) Each subcontract shall include provisions which would entitle the Employer to require the subcontract to be assigned to the Employer under New-Clause 4.23/PCC [Assignment of Benefit of Subcontract] (if or when applicable) or in the event of termination under Sub-Clause 49.7/PCC. [Termination by Employer]; and
- (e) On getting consent from the Engineer, the Contractor shall provide to the Engineer copy of the agreement entered with such subcontractor.

The Contractor shall ensure that the requirements imposed on the Contractor by New-Clause 1.6/PCC [Confidential Details] apply equally to each Subcontractor.

Where practicable, the Contractor shall give fair and reasonable opportunity for contractors from the Country to be appointed as Subcontractors.

The Contractor shall endeavor to resolve all matters and payments amicably and speedily with the sub-contractors.

The Contractor shall indemnify and hold the Employer harmless against and from any claim of subcontractors or suppliers of the materials.

The Contractor shall release payment to the Sub-contractors/Suppliers promptly and shall endeavor to resolve all issues amicably and speedily with the Sub-contractors/Suppliers, so that the execution of work is not affected in any manner whatsoever.

In case a Sub-contractor/Supplier represents to the Engineer in writing with supporting documents, stating that he has not received payment due as per the agreement/work or purchase order for the works executed by such Sub-contractor or supplies made by such Supplier, which have been covered in previous Payment Certificates and the Engineer finds such representation having merit, the Engineer, before issuing next Payment Certificate, may forward a copy of the representation to the Contractor requesting the Contractor to supply reasonable evidence that the amount stated to be outstanding by the Sub-contractor/Supplier for the works executed or supplies made, which have been covered in previous Payment Certificates has been paid and if not, why the same is not payable. The Engineer may recommend to make payment to the Sub-contractor/Supplier unless the Contractor submits reasonable evidence to the Engineer:

- (i) that the amount claimed has been paid, or
- (ii) satisfying the Engineer in writing that the Contractor is entitled to withhold or that the amount is not payable.

On the recommendation of the Engineer, the Employer may (at his sole discretion) directly pay to the Sub-contractor/Supplier the amount due for and on behalf of the Contractor, part or all of such amounts previously certified (less applicable deductions) as are found due to the Sub-contractor/Supplier by the Engineer. The Employer shall adjust the amount paid directly to the Sub-contractor/Supplier from any amount due by it to the Contractor. The Contractor shall repay the amount, in case no amount is found due by the Employer to the Contractor.

That the payment by Employer, on behalf of the Contractor to its Sub-contractor/Supplier, shall not alter any terms of agreement between the Employer and the Contractor and nor the same shall result in any privity of contract between the Employer and the Sub-contractor/Supplier.

Assignment of Contractor's and Sub-contractor's Obligations:

The Contractor shall not assign a right or benefit under the Contract without first obtaining Employer's prior written consent, otherwise than by:

- A. a charge in favor of the Contractor's bankers of any money due or to become due under the Contract, or
- B. assignment to the Contractor's insurers (in cases where the insurers have discharged the Contractor's loss or liability) of the Contractor's right to obtain relief against any other party liable.

If a Subcontractor's obligations extend beyond the expiry date of Defects Liability Period, then the Contractor shall assign the benefits of such obligations to the Employer.

In the event that a sub-contractor of any tier provides to the Contractor or any other sub-contractor a warranty in respect of Plant, Materials or services supplied in connection with the Works, or undertakes a continuing obligation of any nature whatsoever in relation to such Plant, Materials or services (including without limitation an obligation to maintain stocks of spare parts) extending for a period exceeding that of the Defects Liability Period or where there is more than one Defects Liability Period exceeding that of the latest Defects Liability Period, and if the Engineer so directs in writing within 21 days of the expiry of the Defects Liability Period or the latest Defects Liability Period (as the case may be), the Contractor shall immediately assign or

obtain the assignment of the benefit of such warranty or obligation to the Employer or at the direction of the Employer, to any third party.

Specialist Subcontracting

If an Applicant intends to subcontract any highly specialized elements of the Works to specialist subcontractors, such elements and the proposed subcontractors shall be clearly identified, and the experience and capacity of the subcontractors shall be described in the relevant Information Forms.

Acceptable Substitutes

With reference to subcontracting & specialist subcontracting, the Employer may require Applicants to provide more information about their proposals. If any proposed subcontractor is found ineligible or unsuitable to carry out an assigned task, the Employer may request the Applicant to propose an acceptable substitute, and may conditionally pre-qualify the Applicant accordingly, before issuing an invitation to tender.

7.2 Objection to Nomination

The Contractor shall not be under any obligation to employ a nominated Subcontractor against whom the Contractor raises reasonable objection by notice to the Engineer as soon as practicable, with supporting particulars. An objection shall be deemed reasonable if it arises from (among other things) any of the following matters, unless the Employer agrees to indemnify the Contractor against and from the consequences of the matter:

- (a) there are reasons to believe that the Subcontractor does not have sufficient competence, resources or financial strength;
- (b) the subcontract does not specify that the nominated Subcontractor shall indemnify the Contractor against and from any negligence or misuse of Goods by the nominated Subcontractor, his agents and employees; or
- (c) the subcontract does not specify that, for the subcontracted work (including design, if any), the nominated Subcontractor shall:
 - (i) undertake to the Contractor such obligations and liabilities as will enable the Contractor to discharge his obligations and liabilities under the Contract, and
 - (ii) Indemnify the Contractor against and from all obligations and liabilities arising under or in connection with the Contract and from the consequences of any failure by the Subcontractor to perform these obligations or to fulfil these liabilities.

7.3 Payments to nominated Subcontractors

The Contractor shall pay to the nominated Subcontractor the amounts which the Engineer certifies to be due in accordance with the subcontract. These amounts plus other charges shall be included in the Contract Price in accordance with sub-paragraph (b) of Sub-Clause 34.5/PCC [Provisional Sums], except as stated in Sub-Clause 7.4/PCC [Evidence of Payments].

7.4 Evidence of Payments

Before issuing a Payment, Certificate which includes an amount payable to a nominated Subcontractor, the Engineer may request the Contractor to supply reasonable evidence that the nominated Subcontractor has received (Within 7 days of receipt of previous payment by the contractor) all amounts due in accordance with previous Payment Certificates, less

	<p>applicable deductions for retention or otherwise. Unless the Contractor, submits this reasonable evidence to the Engineer, or</p> <ul style="list-style-type: none"> (i) satisfies the Engineer in writing that the Contractor is reasonably entitled to withhold or refuse to pay these amounts, and (ii) submits to the Engineer reasonable evidence that the nominated Subcontractor has been notified of the Contractor's entitlement, <p>then the Employer may (at his sole discretion) pay, direct to the nominated Subcontractor, part or all of such amounts previously certified (less applicable deductions) as are due to the nominated Subcontractor and for which the Contractor has failed to submit the evidence described in sub-paragraphs (a) or (b) above. The Contractor shall then repay, to the Employer, the amount which the nominated Subcontractor was directly paid by the Employer.</p> <p>7.5 Assignment of Benefit of Subcontract</p> <p>If a Subcontractor's obligations extend beyond the expiry date of the relevant Defects Notification Period and the Engineer, prior to this date, instructs the Contractor to assign the benefit of such obligations to the Employer, then the Contractor shall do so. Unless otherwise stated in the assignment, the Contractor shall have no liability to the Employer for the work carried out by the Subcontractor after the assignment takes effect.</p>
<p>Clause11/CC</p>	<p>The following paras are added to the Existing CC Clauses.</p> <p>Risk and Responsibility</p> <p>11.1 Indemnities</p> <p>The Contractor shall indemnify and hold harmless the Employer, the Employer's Personnel, Employers Representative and their respective agents, against and from all claims, damages, losses and expenses (including legal fees and expenses) in respect of:</p> <ul style="list-style-type: none"> (a) bodily injury, sickness, disease or death, of any person including railway user whatsoever arising out of or in the course of or by reason of the Contractor's design (if any), the execution and completion of the Works and the remedying of any defects, unless attributable to any negligence, wilful act or breach of the Contract by the Employer, the Employer's Personnel, or any of their respective agents, and (b) damage to or loss of any property, real or personal (other than the Works), to the extent that such damage or loss arises out of or in the course of or by reason of the Contractor's design (if any), the execution and completion of the Works and the remedying of any defects, unless and to the extent that any such damage or loss is attributable to any negligence, wilful act or breach of the Contract by the Employer, the Employer's Personnel,, their respective agents, or anyone directly or indirectly employed by any of them. <p>The Employer shall indemnify and hold harmless the Contractor, the Contractor's Personnel, and their respective agents, against and from all claims, damages, losses and expenses (including legal fees and expenses) in respect of (1) bodily injury, sickness, disease or death, which is attributable to any negligence, wilful act or breach of the Contract by the Employer, the Employer's Personnel, or any of their respective agents, and (2) the matters for which liability may be excluded from insurance cover, as described in sub-paragraphs (d)(i), (ii) and (iii) of Sub-Clause 13.8/PCC [Insurance Against Injury to Persons and Damage to Property].</p>

11.2 Contractor's Care of the Works

The Contractor shall take full responsibility for the care of the Works and Goods from the Commencement Date until the Taking-Over Certificate is issued (or is deemed to be issued under Sub-Clause 46.1/PCC [Taking Over of the Works and Sections]) for the Works, when responsibility for the care of the Works shall pass to the Employer. If a Taking-Over Certificate is issued (or is so deemed to be issued) for any Section or part of the Works, responsibility for the care of the Section or part shall then pass to the Employer.

After responsibility has accordingly passed to the Employer, the Contractor shall take responsibility for the care of any work which is outstanding on the date stated in a Taking-Over Certificate, until this outstanding work has been completed.

If any loss or damage happens to the Works, Goods or Contractor's Documents during the period when the Contractor is responsible for their care, from any cause not listed in Sub-Clause 11.3/PCC [Employer's Risks], the Contractor shall rectify the loss or damage at the Contractor's risk and cost, so that the Works, Goods and Contractor's Documents conform with the Contract.

The Contractor shall be liable for any loss or damage caused by any actions performed by the Contractor after a Taking-Over Certificate has been issued. The Contractor shall also be liable for any loss or damage which occurs after a Taking-Over Certificate has been issued and which arose from a previous event for which the Contractor was liable.

11.3 Employer's Risks

Clause 11 of CC and clause 38 of CC are substituted with clause 11.3 of PCC as below:

The risks referred to herein below, in so far as they directly affect the execution of the works in the Country, are:

- (a) war, hostilities (whether war be declared or not), invasion, act of foreign enemies,
- (b) rebellion, terrorism, sabotage by persons other than the Contractor's Personnel, revolution, insurrection, military or usurped power, or civil war, within the Country,
- (c) riot, commotion or disorder within the Country by persons other than the Contractor's Personnel,
- (d) munitions of war, explosive materials, ionising radiation or contamination by radio-activity, within the Country, except as may be attributable to the Contractor's use of such munitions, explosives, radiation or radio-activity,
- (e) pressure waves caused by aircraft or other aerial devices travelling at sonic or supersonic speeds,
- (f) use or occupation by the Employer of any part of the utility shifting/modification Works, except as may be specified in the Contract, and
- (g) design of any part of the Works by the Employer's Personnel or by others for whom the Employer is responsible.

11.4 Consequences of Employer's Risks:

If and to the extent that any of the risks listed in Sub-Clause 11.3/PCC above results in loss or damage to the Works, Goods or Contractor's Documents, the Contractor shall promptly

give notice to the Engineer and shall rectify this loss or damage to the extent required by the Engineer.

If the Contractor suffers delay and/or incurs Cost from rectifying this loss or damage, the Contractor shall give a further notice to the Engineer and shall be entitled subject to Sub-Clause 4.1/SCC [Contractor's Claims] to:

- (a) an extension of time for any such delay, if completion is or will be delayed, under Sub-Clause [Extension of Time for Completion], and
- (b) In the case of sub-paragraphs (f) and (g) of Sub-Clause 11.3/PCC [Employer's Risks], Cost shall be payable.

After receiving this further notice, the Engineer shall proceed in accordance with New-Clause 3.5/PCC [Determinations] to agree or determine these matters.

11.5 Intellectual and Industrial Property Rights

In this Sub-Clause, "infringement" means an infringement (or alleged infringement) of any patent, registered design, copyright, trade mark, trade name, trade secret or other intellectual or industrial property right relating to the Works; and "claim" means a claim (or proceedings pursuing a claim) alleging an infringement.

Whenever a Party does not give notice to the other Party of any claim within 28 days of receiving the claim, the first Party shall be deemed to have waived any right to indemnity under this Sub-Clause.

The Employer shall indemnify and hold the Contractor harmless against and from any claim alleging an infringement which is or was:

- (a) an unavoidable result of the Contractor's compliance with the Contract, or
- (b) a result of any Works being used by the Employer:
 - (i) for a purpose other than that indicated by, or reasonably to be inferred from, the Contract, or
 - (ii) in conjunction with anything not supplied by the Contractor, unless such use was disclosed to the Contractor prior to the Base Date or is stated in the Contract.

The Contractor shall indemnify and hold the Employer harmless against and from any other claim which arises out of or in relation to (i) the manufacture, use, sale or import of any Goods, or (ii) any design for which the Contractor is responsible.

If a Party is entitled to be indemnified under this Sub-Clause, the indemnifying Party may (at its cost) conduct negotiations for the settlement of the claim, and any litigation or arbitration which may arise from it. The other Party shall, at the request and cost of the indemnifying Party, assist in contesting the claim. This other Party (and its Personnel) shall not make any admission which might be prejudicial to the indemnifying Party, unless the indemnifying Party failed to take over the conduct of any negotiations, litigation or arbitration upon being requested to do so by such other Party.

	<p>11.6 Limitation of Liability</p> <p>Neither Party shall be liable to the other Party for loss of use of any Works, loss of profit, loss of any contract or for any indirect or consequential loss or damage which may be suffered by the other Party in connection with the Contract, provided that this exclusion shall not apply to any obligation of the Contractor to pay Delay Damages to the Employer under Sub-Clause 26.6/PCC [Delay Damages].</p> <p>The total liability of the Contractor to the Employer, under or in connection with the Contract other than under New-Clause 4.37/PCC [Electricity, Water and Gas], New Clause 4.38/PCC [Employer's Equipment and Free-Issue Material], Sub-Clause 11.1/PCC [Indemnities] and Sub-Clause 11.5/PCC [Intellectual and Industrial Property Rights], shall not exceed the sum as specified in the Contract Data or if nothing is specified in the Contract Data, the accepted Contract Amount.</p> <p>This Sub-Clause shall not limit liability in any case of fraud, deliberate default or reckless misconduct by the defaulting Party.</p> <p>Maximum total liability of Contractor is accepted contract amount.</p> <p>11.7 Use of Employer's Accommodation/ Facilities</p> <p>The Contractor shall take full responsibility for the care of the Employer provided accommodation and facilities, if any, as detailed in the Specification, from the respective dates of hand-over to the Contractor until cessation of occupation (where hand-over or cessation of occupation may take place after the date stated in the Taking-Over Certificate for the Works).</p> <p>If any loss or damage happens to any of the above items while the Contractor is responsible for their care arising from any cause whatsoever other than those for which the Employer is liable, the Contractor shall, at his own cost, rectify the loss or damage to the satisfaction of the Engineer.</p>
<p>Clause 13/CC</p>	<p>The following paras are added to the Existing CC Clauses.</p> <p>INSURANCE</p> <p>13.6 General Requirements for Insurances</p> <p>In this Clause, "insuring Party" means, for each type of insurance, the Party responsible for effecting and maintaining the insurance specified in the relevant Sub-Clause.</p> <p>Wherever the Contractor is the insuring Party, each insurance shall be effected with insurers and in terms approved by the Employer. These terms shall be consistent with any terms agreed by both Parties before the date of the Letter of Acceptance. This agreement of terms shall take precedence over the provisions of this Clause.</p> <p>If a policy is required to indemnify joint insured, the cover shall apply separately to each insured as though a separate policy had been issued for each of the joint insured. If a policy indemnifies additional joint insured, namely in addition to the insured specified in this Clause, (i) the Contractor shall act under the policy on behalf of these additional joint insured except that the Employer shall act for Employer's Personnel, (ii) additional joint insured shall not be entitled to receive payments directly from the insurer or to have any</p>

other direct dealings with the insurer, and (iii) the insuring Party shall require all additional joint insured to comply with the conditions stipulated in the policy.

Periods for submission of insurance:

- a) evidence of insurance: Before start date of work.
- b) relevant policies: Before start date of work.

Each policy insuring against loss or damage shall provide for payments to be made in the currencies required to rectify the loss or damage. Payments received from insurers shall be used for the rectification of the loss or damage.

The relevant insuring Party shall, within the respective periods stated in the Contract Data (calculated from the Commencement Date), submit to the other Party:

- (a) evidence that the insurances described in this Clause have been effected, and
- (b) copies of the policies for the insurances described in Sub-Clause 13.7/PCC [Insurance for Works and Contractor's Equipment] and Sub-Clause 13.8/PCC [Insurance against Injury to Persons and Damage to Property].
- (c) If the contractor fails to submit evidence and copies of the policies as mentioned in (a) & (b) above to prove that the policies have been obtained within the period specified in the contract data, and submits the same later on and from the submitted evidence it is found that the policies have not been obtained within the period specified, the Employer shall recover double the cost of the premium for the period the policies have been delayed.

When each premium is paid, the insuring Party shall submit evidence of payment to the other Party. Whenever evidence or policies are submitted, the insuring Party shall also give notice to the Engineer.

Each Party shall comply with the conditions stipulated in each of the insurance policies. The insuring Party shall keep the insurers informed of any relevant changes to the execution of the Works and ensure that insurance is maintained in accordance with this Clause.

Neither Party shall make any material alteration to the terms of any insurance without the prior approval of the other Party. If an insurer makes (or attempts to make) any alteration, the Party first notified by the insurer shall promptly give notice to the other Party.

If the insuring Party fails to effect and keep in force any of the insurances it is required to effect and maintain under the Contract, or fails to provide satisfactory evidence and copies of policies in accordance with this Sub-Clause, the other Party may (at its option and without prejudice to any other right or remedy) effect insurance for the relevant coverage and pay the premiums due. The insuring Party shall pay double the amount of these premiums to the other Party, and the Contract Price shall be adjusted accordingly.

Nothing in this Clause limits the obligations, liabilities or responsibilities of the Contractor or the Employer, under the other terms of the Contract or otherwise. Any amounts not insured or not recovered from the insurers shall be borne by the Contractor and/or the Employer in accordance with these obligations, liabilities or responsibilities. However, if the insuring Party fails to effect and keep in force an insurance which is available and which it is required to effect and maintain under the Contract, and the other Party neither approves

the omission nor effects insurance for the coverage relevant to this default, any moneys which should have been recoverable under this insurance shall be paid by the insuring Party.

Payments by one Party to the other Party shall be subject to New-Clause 2.4/PCC [Employer's Claims] or Sub-Clause 4.1/SCC [Contractor's Claims], as applicable.

The Contractor shall be entitled to place all insurance relating to the Contract (including, but not limited to the insurance referred to Clause 13/CC/PCC with insurers from any eligible source country.

13.7 Insurance for Works and Contractor's Equipment

The Contractor shall insure the Works, Plant, Materials, including those issued by the Employer and Contractor's Documents for not less than the full reinstatement cost including the costs of demolition, removal of debris and professional fees and profit, subject to a maximum value indicated in Contract Data. This insurance shall be effective from the date by which the evidence is to be submitted under sub-paragraph (a) of Sub-Clause 13.6/PCC [General Requirements for Insurances], until the date of issue of the Taking-Over Certificate for the Works.

The insuring Party shall maintain this insurance to provide cover until the date of issue of the Performance Certificate, for loss or damage for which the Contractor is liable arising from a cause occurring prior to the issue of the Taking-Over Certificate, and for loss or damage caused by the Contractor in the course of any other operations (including those under New-Clause 6/PCC [Defects Liability]).

The insuring Party shall insure the Contractor's Equipment for not less than the full replacement value, including delivery to Site. For each item of Contractor's Equipment, the insurance shall be effective while it is being transported to the Site and until it is no longer required as Contractor's Equipment.

Unless otherwise stated in the Conditions of Contract/SCC, insurances under this Sub-Clause:

- (a) shall be effected and maintained by the Contractor as insuring Party,
- (b) shall be in the joint names of the Parties, who shall be jointly entitled to receive payments from the insurers, payments being held or allocated between the Parties for the sole purpose of rectifying the loss or damage,
- (c) shall cover all loss and damage from any cause not listed in Sub-Clause 11.3/PCC [Employer's Risks],
- (d) shall also cover loss or damage to a part of the Works which is attributable to the use or occupation by the Employer of another part of the Works, and loss or damage from the risks listed in sub-paragraphs (c), (g) and (h) of Sub-Clause 11.3/PCC [Employer's Risks], excluding (in each case) risks which are not insurable at commercially reasonable terms, with deductibles per occurrence of not more than the amount stated in the Contract Data (if an amount is not so stated, this sub-paragraph (d) shall not apply), and
- (e) may however exclude loss of, damage to, and reinstatement of:
 - i) part of the Works which is in a defective condition due to a defect in its design, materials or workmanship (but cover shall include any other parts which are lost or

damaged as a direct result of this defective condition and not as described in sub-paragraph (ii) below),

- ii) a part of the Works which is lost or damaged in order to reinstate any other part of the Works if this other part is in a defective condition due to a defect in its design, materials or workmanship,
- iii) a part of the Works which has been taken over by the Employer, except to the extent that the Contractor is liable for the loss or damage, and
- iv) [DELETED]

If, more than one year after the Base Date, the cover described in sub-paragraph (d) above ceases to be available at commercially reasonable terms, the Contractor shall (as insuring Party) give notice to the Employer, with supporting particulars. The Employer shall then (i) be entitled subject to New-Clause 2.4/PCC [Employer's Claims] to payment of an amount equivalent to such commercially reasonable terms as the Contractor should have expected to have paid for such cover, and (ii) be deemed, unless he obtains the cover at commercially reasonable terms, to have approved the omission under Sub-Clause 13.6/PCC [General Requirements for Insurances].

13.8 Insurance against injury to Persons and Damage to Property

The insuring Party shall insure against each Party's liability for any loss, damage, death or bodily injury which may occur to any physical property (except things insured under Sub-Clause 13.7/PCC [Insurance for Works and Contractor's Equipment]) or to any person (except persons insured under Sub-Clause 13.9/PCC [Insurance for Contractor's Personnel]), which may arise out of the Contractor's performance of the Contract and occurring before the issue of the Performance Certificate.

This insurance shall be for a limit per occurrence of not less than the amount stated in the Contract Data, with no limit on the number of occurrences. If an amount is not stated in the Contract Data, this Sub-Clause shall not apply.

Unless otherwise stated in the Special Conditions of Contract, the insurances specified in this Sub-Clause:

- (a) shall be effected and maintained by the Contractor as insuring Party,
- (b) shall be in the joint names of the Parties,
- (c) shall be extended to cover liability for all loss and damage to the Employer's property including Railways Property (except things insured under Sub-Clause 13.7/PCC) arising out of the Contractor's performance of the Contract, and
- (d) may however exclude liability to the extent that it arises from:
 - (i) the Employer's right to have the Permanent Works executed on, over, under, in or through any land, and to occupy this land for the Permanent Works,
 - (ii) damage which is an unavoidable result of the Contractor's obligations to execute the Works and remedy any defects, and
 - (iii) a cause listed in Sub-Clause 11.3/PCC [Employer's Risks], except to the extent that cover is available at commercially reasonable terms.

13.9 Insurance for Contractor's Personnel

The Contractor shall abide by the provisions of ESIC Act, 1948 (extended from time to time) to take care of insurance against liability for claims, damages, losses and expenses

	<p>(including legal fees and expenses) arising from injury, sickness or disease. In addition, the contractor shall also maintain insurance against liability for claim of death of any person employed by the Contractor or any other of the Contractor's Personnel.</p> <p>The Employer and the Engineer shall also be indemnified under the policy of insurance, except that this insurance may exclude losses and claims to the extent that they arise from any act or neglect of the Employer or of the Employer's Personnel.</p> <p>The insurance shall be maintained in full force and effect during the whole time that these personnel are assisting in the execution of the Works. For a Subcontractor's employees, the insurance may be effected by the Subcontractor, but the Contractor shall be responsible for compliance with this Clause.</p> <p>Maximum number of deductibles for insurance of Employer's risks: Nil</p>
<p>Clause- 22/CC. Right of Access to the Site</p>	<p>The following para is added to the existing CC clause:</p> <p>The Employer shall give the Contractor right of access to, and possession of, all parts of the Site within the time (or times) stated in the Contract Data. The right and possession may not be exclusive to the Contractor. If, under the Contract, the Employer is required to give (to the Contractor) possession of any foundation, structure, plant or means of access, the Employer shall do so in the time and manner stated in the Specification. However, the Employer may withhold any such right or possession until the Performance Security has been received.</p> <p>If no such time is stated in the Contract Data, the Employer shall give the Contractor right of access to, and possession of, the Site within such times as may be required to enable the Contractor to proceed in accordance with the programme submitted under Sub-Clause 25.3/PCC [Programme].</p> <p>If the Contractor suffers delay as a result of a failure by the Employer to give any such right or possession within such time, the Contractor shall give notice to the Engineer and shall be entitled to:</p> <p>(a) an extension of time for any such delay, if completion is or will be delayed, under Sub-Clause 26.5/PCC [Extension of Time for Completion], and</p> <p>After receiving this notice, the Engineer shall proceed in accordance with New-Clause 3.5/PCC [Determinations] to agree or determine these matters.</p> <p>However, if and to the extent that the Employer's failure was caused by any error or delay by the Contractor, including an error in, or delay in the submission of, any of the Contractor's Documents, the Contractor shall not be entitled to such extension of time or new rates.</p> <p>Right of access to the work site will be provided to the successful Contractor. A minimum corridor of 9m will be available. The Contractor to note this while making Launching plans. The Contractor shall prepare, at his cost, approach roads to the site of work and this cost will not be reimbursed by the Employer. The Employer reserves the right to make use of these service roads for themselves or other Contractors working on the project, as and when necessary, without any payment to the Contractor. The barricading to the extent feasible subject to a maximum of 9m width (LHS+RHS) shall be permitted for carrying out the works and suitable barricading width for off-road structures in stages as per the approved sequence of construction. The employer shall grant the contractor right of access to, and/ or possession of the site progressively for the completion of works. The contractor</p>

	will draw/ modify the schedule for completion of work according to progressive possession/ right of such sites.
Clause 25 of CC	<p>The following paras are added to the Existing CC Clauses.</p> <p>25.3 Programme</p> <p>The Contractor shall submit a detailed time programme to the Engineer within 28 days after receiving the notice under Sub-Clause 26.3/PCC [Commencement of Works]. The program shall include the physical and Financial Progress vis-à-vis program and forecast cash flow adopting Project Management Software Primavera/Sure Track/MS Project or as mutually agreed. The program must identify the milestones, interface requirements and program reporting elements. The Contractor shall supply, free of cost one set of authorized software to the Engineer and the soft copy of structured program for the project. This shall be updated every month. The Contractor shall also submit a revised programme whenever the previous programme is inconsistent with actual progress or with the Contractor's obligations. Each programme shall include:</p> <ol style="list-style-type: none"> (a) the order in which the Contractor intends to carry out the Works, including the anticipated timing of each stage of design (if any), Contractor's Documents, procurement, manufacture of Plant, delivery to Site, construction, erection and testing, (b) each of these stages for work by each nominated Subcontractor (as defined in Clause 7/PCC [Nominated Subcontractors]), (c) the sequence and timing of inspections and tests specified in the Contract, and (d) a supporting report which includes: <ol style="list-style-type: none"> (i) a general description of the methods which the Contractor intends to adopt, and of the major stages, in the execution of the Works, and (ii) details showing the Contractor's reasonable estimate of the number of each class of Contractor's Personnel and of each type of Contractor's Equipment, required on the Site for each major stage. <p>Unless the Engineer, within 21 days after receiving a programme, gives notice to the Contractor stating the extent to which it does not comply with the Contract, the Contractor shall proceed in accordance with the programme, subject to his other obligations under the Contract. The Employer's Personnel shall be entitled to rely upon the programme when planning their activities.</p> <p>The Contractor shall promptly give notice to the Engineer of specific probable future events or circumstances which may adversely affect the work, increase the Contract Price or delay the execution of the Works. The Engineer may require the Contractor to submit an estimate of the anticipated effect of the future event or circumstances, and/or a proposal under Sub-Clause 34.3/PCC [Variation Procedure].</p> <p>If, at any time, the Engineer gives notice to the Contractor that a programme fails (to the extent stated) to comply with the Contract or to be consistent with actual progress and the Contractor's stated intentions, the Contractor shall submit a revised programme to the Engineer within 15 days in accordance with this Sub-Clause.</p>
Clause 26 of CC	The following paras are added to the Existing CC Clauses.

26.3 Commencement of Works

The Engineer shall give the Contractor not less than 7 days' notice of the Commencement of work. Unless otherwise stated in the Special Conditions of Contract, the Commencement of work shall be within the number of days after the Contractor receives the Letter of Acceptance as specified in Contract Data.

The Contractor shall commence the execution of the Works as soon as is reasonably practicable after the Commencement Date, and shall then proceed with the Works with due expedition and without delay.

26.4 Time for Completion

The Contractor shall complete the whole of the Works, and each Section (if any), within the Time for Completion for the Works or Section (as the case may be), including:

- (a) achieving the passing of the Tests on Completion, and
- (b) completing all work which is stated in the Contract as being required for whole of the Works or Section(s) to be considered to be completed for the purposes of taking-over under Sub-Clause 46.1/PCC [Taking Over of the Works and Sections].

26.5 Extension of Time for Completion

The Contractor shall be entitled subject to Sub-Clause 4.1/SCC [Contractor's Claims] to an extension of the Time for Completion if and to the extent that completion for the purposes of Sub-Clause 46.1/PCC [Taking-Over of the Works and Sections] is or will be delayed by any of the following causes:

- a) a Variation (unless an adjustment to the Time for Completion has been agreed under Sub-Clause 34.3/PCC [Variation Procedure]) or other substantial change in the quantity of an item of work included in the Contract,
- b) a cause of delay giving an entitlement to extension of time under a Sub-Clause of these Conditions,
- c) exceptionally adverse climatic conditions,
- d) Unforeseeable shortages in the availability of personnel or Goods caused by epidemic or governmental actions, or
- e) any delay, impediment or prevention caused by or attributable to the Employer, the Employer's Personnel, or the Employer's other contractors.

If the Contractor considers himself to be entitled to an extension of the Time for Completion, the Contractor shall give notice to the Engineer in accordance with Sub-Clause 4.1/SCC [Contractor's Claims]. When determining each extension of time under Sub-Clause 4.1/SCC the Engineer shall review previous determinations and may increase, but shall not decrease, the total extension of time.

26.6 Delays Caused by Authorities

If the following conditions apply, namely:

- (a) the Contractor has diligently followed the procedures laid down by the relevant legally constituted public authorities in the Country,

(b) these authorities delay or disrupt the Contractor's work, and

(c) the delay or disruption was Unforeseeable,

then this delay or disruption will be considered as a cause of delay under sub-paragraph (b) of Sub-Clause 26.5/PCC [Extension of Time for Completion].

26.7 Rate of Progress

If, at any time:

(a) actual progress is too slow to complete within the Time for Completion, and/or

(b) progress has fallen (or will fall) behind the current programme under Sub-Clause 25.3/PCC [Programme],

other than as a result of a cause listed in Sub-Clause 26.5/PCC [Extension of Time for Completion], then the Engineer may instruct the Contractor to submit, under Sub-Clause 25.3/PCC [Programme], a revised programme and supporting report describing the revised methods which the Contractor proposes to adopt in order to expedite progress and complete within the Time for Completion.

Unless the Engineer notifies otherwise, the Contractor shall adopt these revised methods, which may require increases in the working hours and/or in the numbers of Contractor's Personnel and/or Goods, at the risk and cost of the Contractor. If these revised methods cause the Employer to incur additional costs, the Contractor shall subject to New-Clause 2.4/PCC [Employer's Claims] pay these costs to the Employer, in addition to delay damages (if any) under Sub-Clause 26.8/PCC below

26.8 Extension of Time for Completion with Delay Damages

If the Contractor fails to comply with Sub-Clause 26.4/PCC [Time for Completion for entire work or for specified section wise completion period], and he is not entitled to an extension of time under sub clause 26.5/PCC then the employer may grant extension of time with delay damage in such case, the Contractor shall subject to New-Clause 2.4/PCC [Employer's Claims] pay delay damages to the Employer for this default. These delay damages shall be the sum stated in the Contract Data, which shall be paid for every day which shall elapse between the relevant Time for Completion and the date stated in the Taking-Over Certificate. However, the total amount due under this Sub-Clause shall not exceed the maximum amount of delay damages (if any) stated in the Contract Data.

Further, if the contractor fails to achieve physical/financial targets as per the agreed programme for a consecutive period of 3 months without any valid reasons, other than attributable to the contractor, a provisional recovery of delay damages shall be made from the next interim payment certificate @ 1/10th of the sum of delay damages stated in the contract data, for the entire period of 3 months. Such recovery shall continue from the further interim payment certificates till the contractor is able to make good the shortfall and achieve the cumulative targets as per agreed programme. On achieving the cumulative progress targets as per agreed programme, the entire amount recovered till that month, shall be refunded to the contractor in the next interim payment certificate. In case the contractor is unable to make good the shortfall and achieve the cumulative targets resulting in delay in completion of the project, then the provisional recoveries made shall be adjusted against the delay damages to be finally imposed on the contractor.

These delay damages shall be the only damages due from the Contractor for such default, other than in the event of termination under Sub-Clause 49.7/PCC [Termination by Employer] prior to completion of the Works. These damages shall not relieve the Contractor from his obligation to complete the Works, or from any other duties, obligations or responsibilities which he may have under the Contract.

26.9 Suspension of Work

The Engineer may at any time instruct the Contractor to suspend progress of part or all of the Works. During such suspension, the Contractor shall protect, store and secure such part or the Works against any deterioration, loss or damage.

The Engineer may also notify the cause for the suspension. If and to the extent that the cause is notified and is the responsibility of the Contractor, the following Sub-Clauses 26.10, 26.11 and 26.12 of PCC shall not apply.

26.10 Consequences of Suspension -DELETED

26.11 Payment for Plant and Materials in Event of Suspension -DELETED

26.12 Prolonged Suspension

If the suspension under Sub-Clause 26.9/PCC [Suspension of Work] has continued for more than 84 days, the Contractor may request the Engineer's permission to proceed. If the Engineer does not give permission within 28 days after being requested to do so, the Contractor may, by giving notice to the Engineer, treat the suspension as an omission under Clause 34/PCC [Variations and Adjustments] of the affected part of the Works. If the suspension affects the whole of the Works, the Contractor may give notice.

26.13 Resumption of Work

After the permission or instruction to proceed is given, the Contractor and the Engineer shall jointly examine the Works and the Plant and Materials affected by the suspension. The Contractor shall make good any deterioration or defect in or loss of the Works or Plant or Materials, which has occurred during the suspension

26.14 Bonus for early completion:

If the Contractor achieves completion of the whole of the Works or any section(s) prior to the intended Completion Date prescribed in Contract data (Extension of time pursuant to Clause 26.5/PCC or any other clause of these conditions will not be considered), the Employer shall pay to the Contractor a sum stated in the Contract data as bonus for early completion, for every calendar month which shall elapse between the date of completion of all items of works as stipulated in the contract, including variations ordered by the Engineer and the time prescribed in Clause 26.4.

For the purpose of calculating bonus payments, the time given in the Bid for completion of the whole works or any section(s) is fixed and unless otherwise agreed, no adjustment of the time by reasons of granting an extension of time pursuant to clause 26.5/PCC or any other clause of these conditions will be allowed. Any period falling short of completed month shall be ignored for the purpose of computing the period relevant for the payment of bonus.

	<p>Amount of bonus for early completion 1% of initial Contract Price per month (part of the month to be excluded) for substantial completion of work.</p> <p>Maximum limit of bonus 3% of Contract Price.</p> <p>(For earlier completion of the work as a whole from the stipulated original date of completion, a bonus payment of as above shall be paid to the contractor. The engineer's decision is final and binding on the contractor so far as bonus payment to the contractor is concerned. if bonus payment is made, earlier penalties levied for delay caused to various intermediate Key Dates will be refunded.)</p>
<p>Clause-30/CC</p>	<p>The following paras are added to the Existing CC Clauses.</p> <p>30.2 Contractor's Obligations</p> <p>The Contractor shall carry out the Tests on Completion in accordance with this Clause and New-Clause 5.4/PCC [Testing], after providing the documents in accordance with sub-paragraph (d) of New--Clause 4.1/PCC [Contractor's General Obligations].</p> <p>The Contractor shall give to the Engineer not less than 21 days' notice of the date after which the Contractor will be ready to carry out each of the Tests on Completion. Unless otherwise agreed, Tests on Completion shall be carried out within 14 days after this date, on such day or days as the Engineer shall instruct.</p> <p>In considering the results of the Tests on Completion, the Engineer shall make allowances for the effect of any use of the Works by the Employer on the performance or other characteristics of the Works. As soon as the Works, or a Section, have passed any Tests on Completion, the Contractor shall submit a certified report of the results of these Tests to the Engineer.</p> <p><u>Contractor's Obligations:</u> The Contractor shall carry out the Tests on Completion at his own cost in accordance with the Contract and shall provide the documents in accordance with New-Clauses 3.1/PCC and the Contractor shall give, to the Engineer, 21days' notice of the date after which the Contractor will be ready to carry out the Tests on Completion. Unless otherwise agreed, such Tests shall be carried out within 14 days after this date, on such day or days as the Engineer shall instruct.</p> <p>Unless otherwise stated in Conditions of Contract/SCC, the Tests on Completion shall be carried out in the following sequence</p> <ol style="list-style-type: none"> (a) pre-commissioning test, which shall include appropriate instructions and ("dry" or "cold") functional tests to demonstrate that each item of the Plant and Work can safely undertake the next stage (b) Commissioning Test shall include the specified operational tests to demonstrate Works or Sections can be operated safely and as specified under all available operating condition (c) trial operation which shall demonstrate that the Works or Section perform reliably and in accordance with the Contract <p>The Contractor at his own cost shall arrange all tools, equipment, gadgets, facilities or as deemed necessary by the Engineer for such tests, in considering the results of the Tests on Completion, the Engineer shall make allowances for the effect of any use of the Works by the Employer on the performance or other characteristics of the Works. As soon as the</p>

Works, or a Section, have passed the Tests on Completion described in sub-paragraphs (a) (b) or (c), the Contractor shall provide the Engineer and the Employer with a certified report of the results of all such Tests

30.3 Delayed Tests

If the Tests on Completion are being unduly delayed by the Employer, New-Clause 5.4/PCC [Testing] (fifth paragraph) and/or Sub-Clause 46.3/PCC [Interference with Tests on Completion] shall be applicable.

If the Tests on Completion are being unduly delayed by the Contractor, the Engineer may by notice require the Contractor to carry out the Tests within 21 days after receiving the notice. The Contractor shall carry out the Tests on such day or days within that period as the Contractor may fix and of which he shall give notice to the Engineer.

If the Contractor fails to carry out the Tests on Completion within the period of 21 days, the Employer's Personnel may proceed with the Tests at the risk and cost of the Contractor. The Tests on Completion shall then be deemed to have been carried out in the presence of the Contractor and the results of the Tests shall be accepted as accurate.

30.4 Retesting

If the Works, or a Section, fail to pass the Tests on Completion, New-Clause 5.5/PCC [Rejection] shall apply, and the Engineer or the Contractor may require the failed Tests, and Tests on Completion on any related work, to be repeated under the same terms and conditions

30.5 Failure to Pass Tests on Completion

If the Works, or a Section, fail to pass the Tests on Completion repeated under Sub-Clause 30.4/PCC [Retesting], the Engineer shall be entitled to:

- (a) order further repetition of Tests on Completion under Sub-Clause 30.4;
- (b) if the failure deprives the Employer of substantially the whole benefit of the Works or Section, reject the Works or Section (as the case may be), in which event the Employer shall have the same remedies as are provided in sub-paragraph (c) of New-Clause 6.4/PCC [Failure to Remedy Defects]; or
- (c) issue a Taking-Over Certificate, if the Employer so requests.

In the event of sub-paragraph (c), the Contractor shall proceed in accordance with all other obligations under the Contract, and the Contract Price shall be reduced by such amount as shall be appropriate to cover the reduced value to the Employer as a result of this failure. Unless the relevant reduction for this failure is stated (or its method of calculation is defined) in the Contract, the Employer may require the reduction to be (i) agreed by both Parties (in full satisfaction of this failure only) and paid before this Taking-Over Certificate is issued, or (ii) determined and paid under New-Clause 2.4 [Employer's Claims] and New-Clause 3.5 [Determinations].

30.6 Contractor's obligations

Notwithstanding the provisions of New-clauses 4.1/PCC, clause 30.2 to 30.5/PCC the provisions in subsequent sub-clauses shall apply for works of Permanent Way, signalling and telecommunication and railway electrification excluding General Electrical Services.

- (a) The Contractor shall be responsible for the execution of temporary and/or permanent works which may require the prior sanction/approval of EIG/Commissioner of Railway Safety (CRS) in accordance with extant rules for "The Railways opening for Public

	<p>Carriage of Passengers” was amended from time to time. And applicable as and when the works are undertaken. The Contractor shall initiate the process for approval at least 63 (sixty-three) days prior to undertaking such works which require the approval of Commissioner of Railway Safety (CRS) and furnish draft documentation to the Engineer.</p> <p>(b) The Contractor shall ensure that existing services and operations for public carriage of passengers or goods, are not affected except those, which are essentially required to be regulated for execution of works. Such items of works shall be planned and coordinated through the Engineer.</p> <p>(i) Prior to the commencement of commercial operations of passenger traffic, the Employer may permit freight train operations to Railway after certification by the authorized person of Zonal Railway. The Contractor shall be responsible for maintaining the facilities ensuring safety of operations as per specifications.</p>
<p>Clause 34/CC</p>	<p>The following paras are replaced to the Existing CC Clause 34.</p> <p>VARIATIONS AND ADJUSTMENTS.</p> <p>34.1 Right to Vary</p> <p>Variations may be initiated by the Employer at any time prior to issuing the Taking-Over Certificate for the Works, either by an instruction or by making a request to the Contractor to submit a proposal.</p> <p>The Contractor shall execute and be bound by each variation till the price does not exceed 50% of the agreement value as specified in LOA/Original agreement. For variation beyond the above the contractor shall be bound to execute, unless the Contractor promptly gives notice to the Engineer stating (with supporting particulars) that the Contractor cannot readily obtain the Goods required for the Variation. Upon receiving this notice, the Engineer shall cancel, confirm or vary the instruction.</p> <p>Each Variation may include:</p> <p>(a) changes to the quantities of any item of work included in the Contract,</p> <p>(b) changes to the quality and other characteristics of any item of work,</p> <p>(c) changes to the levels, positions and/or dimensions of any part of the Works,</p> <p>(d) omission of any work unless it is to be carried out by others,</p> <p>(e) any additional work, Plant, Materials or services necessary for the Permanent Works, including any associated Tests on Completion, boreholes and other testing and exploratory work, or</p> <p>(f) changes to the sequence or timing of the execution of the Works.</p> <p>The Contractor shall not make any alteration and/or modification of the Permanent Works, unless and until the Engineer instructs or approves a Variation</p> <p>34.2 Value Engineering</p> <p>The Contractor may, at any time, submit to the Engineer a written proposal which (in the Contractor’s opinion) will, if adopted, (i) accelerate completion, (ii) reduce the cost to the Employer of executing, maintaining or operating the Works, (iii) improve the efficiency or value to the Employer of the completed Works, or (iv) otherwise be of benefit to the Employer.</p>

The proposal shall be prepared at the cost of the Contractor and shall include the items listed in Sub-Clause 34.3/PCC [Variation Procedure].

If a proposal, which is approved by the Engineer, includes a change in the design of part of the Permanent Works, then unless otherwise agreed by both Parties:

- (a) the Contractor shall design this part,
- (b) sub-paragraphs (a) to (d) of New-Clause 4.1/PCC [Contractor's General Obligations] shall apply, and
- (c) if this change results in a reduction in the contract value of this part, the Engineer shall proceed in accordance with New-Clause 3.5/PCC [Determinations] to agree or determine a fee, which shall be included in the Contract Price. This fee shall be half (50%) of the difference between the following amounts:
 - (i) such reduction in contract value, resulting from the change, excluding adjustments under Sub-Clause 34.7/PCC [Adjustments for Changes in Legislation] and Sub-Clause PVC/Contract Data [Adjustments for Changes in Cost], and
 - (ii) the reduction (if any) in the value to the Employer of the varied works, taking account of any reductions in quality, anticipated life or operational efficiencies.

However, if amount (i) is less than amount (ii), there shall not be a fee.

34.3 Variation Procedure

If the Engineer requests a proposal, prior to instructing a Variation, the Contractor shall respond in writing as soon as practicable, either by giving reasons why he cannot comply (if this is the case) or by submitting:

- (a) a description of the proposed work to be performed and a programme for its execution,
- (b) the Contractor's proposal for any necessary modifications to the programme according to Sub-Clause 25.3/PCC [Programme] and to the Time for Completion, and
- (c) the evaluation of the Variation shall be as specified in New-Clause 35/PCC [Payment for Variation].

The Engineer shall, as soon as practicable after receiving such proposal (under Sub-Clause 34.2/PCC [Value Engineering] or otherwise), respond with approval, disapproval or comments. The Contractor shall not delay any work whilst awaiting a response.

Each instruction to execute a Variation, with any requirements for the recording of Costs, shall be issued by the Engineer to the Contractor, who shall acknowledge receipt.

Each Variation shall be evaluated in accordance with New-Clause 7 [Measurement and Evaluation], unless the Engineer instructs or approves otherwise in accordance with this Clause.

34.4 Payment in Applicable Currencies

If the Contract provides for payment of the Contract Price in more than one currency, then whenever an adjustment is agreed, approved or determined as stated above, the amount payable in each of the applicable currencies shall be specified. For this purpose, reference shall be made to the actual or expected currency proportions of the Cost of the varied work, and to the proportions of various currencies specified for payment of the Contract Price.

34.5 Provisional Sums

Each Provisional Sum shall only be used, in whole or in part, in accordance with the Engineer's instructions, and the Contract Price shall be adjusted accordingly. The total sum paid to the Contractor shall include only such amounts, for the work, supplies or services to which the Provisional Sum relates, as the Engineer shall have instructed. For each Provisional Sum, the Engineer may instruct:

- (a) work to be executed (including Plant, Materials or services to be supplied) by the Contractor and valued under Sub-Clause 34.3/PCC [Variation Procedure]; and/or
- (b) Plant, Materials or services to be purchased by the Contractor, from a nominated Subcontractor (as defined in Clause 7 [Nominated Subcontractors]) or otherwise; and for which these shall be included in the Contract Price:
 - (i) the actual amounts paid (or due to be paid) by the Contractor, and
 - (ii) a sum for overhead charges and profit, calculated as a percentage of these actual amounts by applying the relevant percentage rate (if any) stated in the appropriate Schedule. If there is no such rate, the percentage rate stated in the Contract Data shall be applied.

The Contractor shall, when required by the Engineer, produce quotations, invoices, vouchers and accounts or receipts in substantiation

34.6 Day work

For work of a minor or incidental nature, the Engineer may instruct that a Variation shall be executed on a daywork basis. The work shall then be valued in accordance with the Daywork Schedule included in the Contract, and the following procedure shall apply. If a Daywork Schedule is not included in the Contract, this Sub-Clause shall not apply.

Before ordering Goods for the work, the Contractor shall submit quotations to the Engineer. When applying for payment, the Contractor shall submit invoices, vouchers and accounts or receipts for any Goods.

Except for any items for which the Daywork Schedule specifies that payment is not due, the Contractor shall deliver each day to the Engineer accurate statements in duplicate which shall include the following details of the resources used in executing the previous day's work:

- (a) the names, occupations and time of Contractor's Personnel,
- (b) the identification, type and time of Contractor's Equipment and Temporary Works, and
- (c) the quantities and types of Plant and Materials used.

One copy of each statement will, if correct, or when agreed, be signed by the Engineer and returned to the Contractor. The Contractor shall then submit priced statements of these resources to the Engineer, prior to their inclusion in the next Statement under Sub-Clause 37.1/PCC [Application for Interim Payment Certificates]

34.7 Adjustments for Changes in Legislation

Contract Price shall be adjusted to take account of any increase or decrease in Cost resulting from a change in the Laws of the Country (including the introduction of new Laws and the repeal or modification of existing Laws) or in the judicial or official governmental interpretation of such Laws, made after the Base Date, which affect the Contractor in the performance of obligations under the Contract.

	<p>If the Contractor suffers (or will suffer) delay and/or incurs (or will incur) additional Cost as a result of these changes in the Laws or in such interpretations, made after the Base Date, the Contractor shall give notice to the Engineer and shall be entitled subject to Sub-Clause 4.1/SCC [Contractor's Claims] to:</p> <p>(a) an extension of time for any such delay, if completion is or will be delayed, under Sub-Clause 26.5/PCC [Extension of Time for Completion], and</p> <p>(b) payment of any such Cost, which shall be included in the Contract Price.</p> <p>After receiving this notice, the Engineer shall proceed in accordance with New-Clause 3.5 [Determinations] to agree or determine these matters.</p> <p>In case there is a decrease in cost as a result of changes of Law by Legislation after the Base Date, the Engineer shall proceed in accordance with New-Clause 3.5 (determination) to agree or determine these matters without waiting for Contractor's / Employer's Notice.</p> <p>Notwithstanding the foregoing, the Contractor shall not be entitled to such an extension of time if the same shall already have been taken into account in determining an extension and such Cost shall not be separately paid if the same shall already have been taken into account in the indexing of any inputs to the table of adjustment data in accordance with the provisions of Sub-Clause PVC/Contract Data.</p>
<p>Clause 35/CC</p>	<p>The clause 35 of CC is substituted with following paras.</p> <p>1. Payment for Variations/New Items.</p> <p>1.1. Variation in the Bill of Quantities</p> <p>i) The quantities of items shown in the Bill of Quantities are approximate, and liable to vary during the actual execution of the work. Some items/group of items may have to be altered, added or omitted. The Contractor shall be bound to carry out and complete the stipulated work as instructed by the Engineer, irrespective of the magnitude of variations including additions, alterations or omissions in the Bill of Quantities, individual items or group of items, specified in the Bill of Quantities.</p> <p>Such variations shall be paid as follows:</p> <p>1.2 Payment for the increase in the quantities of an item in the BOQ up to 25 % of that provided in the Bill of Quantities shall be made at the rates quoted by the Contractor, except in the case of foundation.</p> <p>1.3 In case of foundation work, no variation limit applies and Contractor shall carryout the Work, at rates stipulated in the Contract irrespective of any variation.</p> <p>1.4 For quantities in excess of 125% of the tendered quantity of an item as given in the BOQ, the Contractor shall be paid at the reasonable rate derived from the details mentioned in para no. 3 (applicable for the area of work and current at the time of variations), plus-minus the overall percentage of the original tendered rates over the current schedule of rates prevalent at the time of contract.</p> <p>1.5 If there is no rate for the additional, substituted, or altered item of the work in the BOQ, efforts would be made to derive the rates from those given in the BOQ or the Schedule of Rates (applicable for the area of the work and current at the time of award of Contract) and if found feasible the payment would be made at the derived rate for the item plus or minus the overall percentage of the original</p>

tendered rates over the current Schedule of Rates prevalent at the time of award of Contract.

- 1.6 If the rates for additional, substituted, or altered items of work cannot be determined either as at 1.2, 1.4, or 1.5 above, the Contractor shall be requested to submit his quotation for the items supported by analysis of the rate or rates claimed, within 7 days.
- 1.7 If the Contractor's quotation is determined unreasonable, the Employer may order the Variation and make a change to the Contract Price which shall be based on the Employer's own forecast of the effects of the Variation on the Contractor's costs.
- 1.8 Under no circumstances the Contractor shall suspend the work on the plea of non-settlement of rates for items falling under this Clause.

2. Procedure for the operation of new items/ variations

The following procedure is to be followed in dealing with the proposal for variation in contractual quantity and/or new items

- 2.1 If any item of work that is not provided for in the BOQ or in case of variation in BOQ Quantity is to be operated, the contractor shall take the instructions in writing from the Engineer as per the relevant Clause specified in the conditions of the contract on Variations.
- 2.2 The contractor on receipt of the instructions shall submit a proposal with the details as specified in the Contract including the proposed rates for the items and proper analysis for the same. (New items and Beyond 125 % of individual items in case of variation)

3. Rate for variation and new items

General principle to be adopted shall be, in case of relevant LAR is available it should be considered. In the absence of relevant LAR, SOR rates/ analysis mentioned as per SOR to be followed.

In case of General Electrical works and utility shifting works policy letter issued from time to time by government of Karnataka shall be followed.

The rate for new items or variations beyond 125% may be derived from the latest reasonable rates of following sequence:

KRIDE LAR
SWR LAR
BMRCL LAR
SOR of KPWD/KPTCL
USSOR Railways
SOR of CPWD

In the absence/conflict of above (LAR/ SOR) rate may be derived as below.

- a. Cost of Materials at current market price, as may be actually utilized in the final finished Permanent Works, including a reasonable percentage for wastage and transportation.

	<p>b. Cost of enabling works, if any, (unless provided for separately) worked out on the above basis but with less stringent quality. Specifications minus the salvage value of serviceable material released after completion of work and cost of material released as scrap.</p> <p>c. Cost of labor actually used at the site of work at rates under Payment of Minimum Wages Act for the area of work for each category of workers, further enhanced by a percentage of 10o/o of the aforesaid rates to account for labor not directly utilized at the Site and other ancillary and incidental expenses on labor.</p> <p>d. Hire charges for Plant and Machinery, scaffolding, shuttering, forms, etc. required to be used at the site of the work. The tools used by the various trades shall not be counted as Plant & Machinery for this purpose.</p> <p>e. An amount of 10% of items a, b, c & d above to allow for the Contractor's overheads and profit. This percentage shall also apply to the estimated cost of Materials supplied free to the contractor.</p> <p>f. All taxes as applicable on above.</p>
<p>Clause 37/CC</p>	<p>The clause 37 of CC is replaced with the following.</p> <p>Payments.</p> <p>37.1 Application for Interim Payment Certificates</p> <p>Payments shall be adjusted for deductions for advance payments other than recoveries in terms of contract and taxes, at source as applicable under law. The Contractor shall be liable to pay liquidated damages for shortfall in progress. Items of the Works for which no rate or price has been entered in will not be paid for by the Employer and shall be deemed covered by other rates and prices in the Contract.</p> <p>The Contractor shall submit a Statement in six copies to the Engineer in accordance with the payment procedure specified by the Engineer, after the end of each month, in a form approved by the Engineer, showing in detail the amounts to which the Contractor considers himself to be entitled, together with supporting documents which shall include the report on the progress during this month in accordance with New-Clause 4.39/PCC [Progress Reports] and Record Measurement Sheets.</p> <p>The Statement shall include the following items, as applicable, which shall be expressed in the various currencies in which the Contract Price is payable, in the sequence listed:</p> <p>(a) the estimated contract value of the Works executed and the Contractor's Documents produced up to the end of the month (including Variations but excluding items described in sub-paragraphs (b) to (g) below);</p> <p>(b) any amounts to be added and deducted for changes in legislation and changes in cost, in accordance with Sub-Clause 34.7/PCC [Adjustments for Changes in Legislation] and Sub-Clause PVC/Contract Data [Adjustments for Changes in Cost];</p> <p>(c) any amount to be deducted for retention, calculated by applying the percentage of retention stated in the Contract Data to the total of the above amounts, until the amount so retained by the Employer reaches the limit of Retention Money (if any) stated in the Contract Data;</p>

- (d) Any amounts to be added and deducted for the advance payments and repayments in accordance with sub clause 42.0/PCC [Advance Payment];
- (e) any amounts to be added and deducted for Materials in accordance with New-Clause 13/PCC [Materials intended for the Works];
- (f) any other additions or deductions which may have become due under the Contract or otherwise, including those under Clause 4.1/SCC [Claims, Disputes and Arbitration]; and
- (g) the deduction of amounts certified in all previous Payment Certificates.
- (h) for invoicing as per GST Laws, the estimated contract value of the Works executed in terms of (a) above and any amounts added or deducted as per (b), (e) to (g) above is to be broken up in two components i.e. (i) the base amount excluding GST (ii) GST component (calculated at the rate for works contract service as per GST Laws).
- (i) Statement of interim payments certificates should be submitted by the Contractor to the Engineer by the 7th day of each month for the work executed upto the end of the previous month.
- (j) An amount to be deducted for the payments to be made to different Departments towards payments liable to be made by the Contractor

37.2 Schedule of Payments

If the Contract includes a schedule of payments specifying the installments in which the Contract Price will be paid, then unless otherwise stated in this schedule:

- (a) the installments quoted in this schedule of payments shall be the estimated contract values for the purposes of sub-paragraph (a) of Sub-Clause 37.1/PCC [Application for Interim Payment Certificates];
- (b) New-Clause 13/PCC [Provisional payment against material at site] shall not apply; and
- (c) if these installments are not defined by reference to the actual progress achieved in executing the Works, and if actual progress is found to be less than that on which this schedule of payments was based, then the Engineer may proceed in accordance with New-Clause 3.5/PCC [Determinations] to agree or determine revised installments, which shall take account of the extent to which progress is less than that on which the installments were previously based.

If the Contract does not include a schedule of payments, the Contractor shall submit non-binding estimates of the payments which he expects to become due during each quarterly period. The first estimate shall be submitted within 42 days after the Commencement Date. Revised estimates shall be submitted at quarterly intervals, until the Taking-Over Certificate has been issued for the Works.

37.3 Issue of Interim Payment Certificates

No amount will be certified or paid until the employer has received and approved the performance security. Thereafter, the Engineer shall within two days after receiving a statement and supporting documents (including Contractor's certificate in terms of Sub-Clause 1.22/SCC, issue to the Employer a provisional interim payment certificate which shall state the amount which the Engineer determines to be due after preliminary check as

per K-RIDE's procedure order. After this the Engineer shall, within 28 days after receiving a statement and supporting documents, issue to the employer an Interim Payment Certificate which shall state the amount which the Engineer fairly determines to be due, with supporting particulars.

However, prior to issuing the Taking-Over Certificate for the Works, the Engineer shall not be bound to issue the Interim Payment Certificate in an amount which would (after retention and other deductions) be less than the minimum amount of Interim Payment Certificates (if any) stated in the Contract Data. In this event, the Engineer shall give notice to the Contractor accordingly.

An Interim Payment Certificate shall not be withheld for any other reason, although:

- (a) if anything supplied or work done by the Contractor is not in accordance with the Contract, the cost of rectification or replacement may be withheld until rectification or replacement has been completed; and/or
- (b) if the Contractor was or is failing to perform any work or obligation in accordance with the Contract, and had been so notified by the Engineer, the value of this work or obligation may be withheld until the work or obligation has been performed.

The Engineer may in any Payment Certificate make any correction or modification that should properly be made to any previous Payment Certificate. A Payment Certificate shall not be deemed to indicate the Engineer's acceptance, approval, consent or satisfaction.

37.4 Payment

The Employer shall pay to the Contractor:

- (a) the first installment of the advance payment within 42 days after issuing the Letter of Acceptance or within 21 days after receiving the documents in accordance with New-Clause 4.19/PCC [Performance Security] and Sub-Clause 42.0/PCC [Advance Payment], whichever is later;
- (b) **DELETED**
- (c) the amount certified in the Final Payment Certificate within 56 days after the Employer receives this Payment Certificate or, the undisputed amount shown in the Final Statement, within 56 days after the date of notification of the suspension.

Payment of the amount due, unless specified in the Contract Data, shall be made in INR into the bank account, nominated by the Contractor.

However, in case of JV, direct payment to individual JV partners shall be made on joint certification (about the net amounts payable to individual partners) by the authorized representative of the JV and concerned respective authorized representative of individual JV partners, after making requisite recoveries/deductions from the gross payment. In case of any dispute regarding the net amounts payable to individual partners, the Engineer shall decide the same on the basis of the execution of items of works under Schedules/Bills indicated in the JV agreement as the responsibility of execution of each JV partner. Payment to individual JV partners shall be treated as payment made to the JV. The said payment shall not alter any obligation of the JV and its individual Partners under the Agreement and their obligations under the agreement shall remain joint and several.

A foreign company (either single entity or JV partner), shall have to submit proof of having opened their project office in India before any payment (including advance

payment) is released to such a company. The required proof here shall be a copy of the report containing information as per format prescribed by Reserve Bank of India submitted to the Director General of Police (DGP) of the state concerned in which project office has been established.

37.5 DELETED

37.6 Delayed Payment-

If the Contractor does not receive payment in accordance with Sub-Clause 37.4/PCC [Payment], the Contractor shall be entitled to receive interest compounded monthly on the amount unpaid during the period of delay. This period shall be deemed to commence on the date for payment specified in Sub-Clause 37.4/PCC [Payment], irrespective (in the case of its sub-paragraph (b)) of the date on which any Interim Payment Certificate is issued.

Unless otherwise stated in the Special Conditions of Contract, the interest amount be calculated at the annual rate of 7% (seven percent).

The Contractor shall be entitled to this payment without formal notice or certification, and without prejudice to any other right or remedy, if the Contractor submits the complied (Fulfilled) documents.

37.7 DELETED

37.8 DELETED

37.9 DELETED

37.10 DELETED

37.11 Statement at Completion

Within 84 days after receiving the Taking-Over Certificate for the Works, the Contractor shall submit to the Engineer six copies of a Statement at completion with supporting documents, in accordance with Sub-Clause 37.7/PCC [Application for Interim Payment Certificates], showing:

- (a) the value of all work done in accordance with the Contract up to the date stated in the Taking- Over Certificate for the Works,
- (b) any further sums which the Contractor considers to be due, and
- (c) an estimate of any other amounts which the Contractor considers will become due to him under the Contract. Estimated amounts shall be shown separately in this Statement at completion.

The Engineer shall then certify in accordance with Sub-Clause 37.3/PCC [Issue of Interim Payment Certificates].

Within 56 days after receiving the Performance Certificate, the Contractor shall submit, to the Engineer, six copies of a draft final statement as per procedure prescribed by the Engineer, with supporting documents showing in detail in a form approved by the Engineer:

37.12 Application for Final Payment Certificate

Within 56 days after receiving the Performance Certificate, the Contractor shall submit, to the Engineer, six copies of a draft final statement as per procedure prescribed by the

Engineer, with supporting documents (including Contractor's certificate in terms of Sub-Clause 1.22/SCC showing in detail in a form approved by the Engineer:

- (a) the value of all work done in accordance with the Contract, and
- (b) any further sums which the Contractor considers to be due to him under the Contract or otherwise.

If the Engineer disagrees with or cannot verify any part of the draft final statement, as per procedure prescribed by the Engineer the Contractor shall submit such further information as the Engineer may reasonably require and shall make such changes in the draft as may be agreed between them. The Contractor shall then prepare and submit to the Engineer the final statement as agreed. This agreed statement is referred to in these Conditions as the "Final Statement".

However, if, following discussions between the Engineer and the Contractor and any changes to the draft final statement which are agreed, it becomes evident that a dispute exists, the Engineer shall deliver to the Employer (with a copy to the Contractor) an Interim Payment Certificate for the agreed parts of the draft final statement. Thereafter, if the dispute is finally resolved under Sub-Clause 4.SCC [Obtaining Dispute Board's Decision] or Sub-Clause 4.2/SCC [Amicable Settlement], the Contractor shall then prepare and submit to the Employer (with a copy to the Engineer) a Final Statement.

37.13 Discharge

When submitting the Final Statement, the Contractor shall submit a discharge which confirms that the total of the Final Statement represents full and final settlement of all moneys due to the Contractor under or in connection with the Contract. This discharge may state that it becomes effective when the Contractor has received the Performance Security and the outstanding balance of this total, in which event the discharge shall be effective on such date

37.14 Issue of Final Payment Certificate

Within 28 days after receiving the Final Statement and discharge in accordance with Sub-Clause 37.12/PCC [Application for Final Payment Certificate] and Sub-Clause 37.13/PCC [Discharge], the Engineer shall issue, to the Employer, the Final Payment Certificate which shall state:

- (a) the amount which he fairly determines is finally due, and
- (b) after giving credit to the Employer for all amounts previously paid by the Employer and for all sums to which the Employer is entitled, the balance (if any) due from the Employer to the Contractor or from the Contractor to the Employer, as the case may be.

If the Contractor has not applied for a Final Payment Certificate in accordance with Sub-Clause 37.12/PCC [Application for Final Payment Certificate] and Sub-Clause 37.13/PCC [Discharge], the Engineer shall request the Contractor to do so. If the Contractor fails to submit an application within a period of 28 days, the Engineer shall issue the Final Payment Certificate for such amount as he fairly determines to be due.

37.15 Cessation of Employer's Liability

The Employer shall not be liable to the Contractor for any matter or thing under or in connection with the Contract or execution of the Works, except to the extent that the Contractor shall have included an amount expressly for it:

- (a) in the Final Statement and also
- (b) (except for matters or things arising after the issue of the Taking-Over Certificate for the Works) in the Statement at completion described in Sub-Clause 37.11/PCC [Statement at Completion].

However, this Sub-Clause shall not limit the Employer's liability under his indemnification obligations, or the Employer's liability in any case of fraud, deliberate default or reckless misconduct by the Employer

37.16 Currencies of Payment

- a) The Contract Price shall be paid in Indian Rupees (INR).

37.17 Tax Deduction at Source: Tax deductions will be made at source as per statutory requirement from every payment made to the Contractor at rates notified from time to time.

- i. **Income tax deduction:** Income Tax deduction shall be as per law.
- ii. **Labour Cess & Royalties:** The labour Cess & Royalties will be deducted as per norms of applicable law from each IPCs and remitted to the respective Authorities

37.18 Production of Vouchers

- a. The Contractor shall, whenever required by the Engineer, produce or cause to be produced for examination by the Engineer, any quotation, invoice, cost or other account books, vouchers, receipts, letters, memoranda or any copy of or extract from any such documents and also furnish information and returns, as may be required, relating to the execution of this Contract or relevant for verifying or ascertaining the cost of execution of this Contract or ascertaining the Materials supplied by the Contractor are in accordance with the Specifications laid down in the Contract. The Engineer's decision on the question of relevancy of any documents, information or returns shall be final and binding on the parties
- b. If any part or item of the Work is allowed to be carried out by a Sub-Contractor, assignee or any subsidiary or allied firm, the Engineer shall have power to secure the books of such Sub-Contractor, assignee or any subsidiary or allied firm through the Contractor, and shall have power to examine and inspect the same. The above obligations are without prejudice to the obligations of the Contractor under any statute, rules or orders.

37.19 Withholding and Lien For Sums Claimed

- (i) The Employer shall have lien on and over all materials of every description, tools, tackles, plant, equipment or any amount due and/or that may become due and payable to the Contractor under the Contract, and / or on and over the deposit of Performance Security or other amount or amounts made under the Contract and which may become payable to the Contractor. Employer may exercise a general lien also.
- (ii) And further, unless the Contractor pays and clears immediately on demand any claim of the Employer, the Employer shall at all times be entitled to deduct the amount of the

	<p>said claim from the amount, securities and / or deposits which may have become or will become payable to the Contractor under the existing contract, or under any other Contract or transaction whatsoever between the Employer and the Contractor even if the matter stands referred to Arbitration. The Contractor shall have no claim for any interest or damage whatsoever in respect of any amounts withheld or treated as withheld under the lien referred to above and duly notified as such to the Contractor</p> <p>37.20 Signature on Receipts for Payments</p> <p>Every receipt of payment to Contractor including refund of the Performance Security shall be signed by the person authorized to do so on his behalf. In the event of death of any of the Contractor's partners in case the Contractor is a partnership firm, during the currency of the Contract, it is hereby expressly agreed that every receipt by any one of surviving Contractor's partners, shall, if so signed as aforesaid, be a good and sufficient discharge as aforesaid, provided that nothing in this Clause shall be deemed to prejudice or affect any claim, which the Employer may hereafter have against the legal representatives of any Contractor's partner so dying, for or in respect of breach of any of the conditions of the Contract. Provided also that nothing contained in this clause shall be deemed to prejudice or affect the respective rights and obligations of the Contractor's partners, or of the legal heirs / representatives of any deceased Contractor / partner interest</p> <p>37.21 Post Payment Audit</p> <p>It is an agreed term of the Contract, that the Employer reserves to himself the right to carry out a post payment audit and / or technical examination of the Works, and the Final bill including all supporting vouchers, abstracts, etc., and to make a claim on the Contractor for the refund of any excess amount paid to him, if as a result of such examination, any over-payment to him is discovered to have been made in respect of any work done or alleged to have been done by the Contractor, under the Contract. If any under-payment is discovered, the same shall be paid by the Employer to the Contractor. Such payments or recoveries, however, shall not carry any interest.</p> <p>37.22 Recovery of money due to the Employer</p> <p>All damages (including, without limitation, liquidated damages), costs, charges, expenses, debts, or sums for which the Contractor is liable to the Employer under any provision of the Contract may be deducted by the Employer from amount due to the Contractor under the Contract including, without limitation, and the Employer shall have the power to recover any balance not so deducted from amount due to the Contractor under any other contract between the Employer and the Contractor</p> <p>When the Contractor has assigned to a third party the right to receive amount due, or, to become due, under the Contract to the Contractor or charged such amount in favour of a third party, the Employer's right to deduct damages (including without limitation liquidated damages), costs, charges, expenses, debts or sums for which the Contractor is liable to the Employer from amount due to the Contractor under the Contract shall be limited to the right expressed above.</p>
<p>Clause-38/CC</p>	<p>The clause 38 of CC is substituted with the following para.</p> <p>38.1 Compensation Event:</p> <p>The risks referred to in Sub-Clause 11.4/PCC below, in so far as they directly affect the execution of the works in the Country, are:</p> <p>(a) war, hostilities (whether war be declared or not), invasion, act of foreign enemies,</p>

	<ul style="list-style-type: none"> (b) rebellion, terrorism, sabotage by persons other than the Contractor's Personnel, revolution, insurrection, military or usurped power, or civil war, within the Country, (c) riot, commotion or disorder within the Country by persons other than the Contractor's Personnel, (d) munitions of war, explosive materials, ionising radiation or contamination by radio-activity, within the Country, except as may be attributable to the Contractor's use of such munitions, explosives, radiation or radio-activity, (e) pressure waves caused by aircraft or other aerial devices travelling at sonic or supersonic speeds, (f) use or occupation by the Employer of any part of the Permanent Works, except as may be specified in the Contract, (g) design of any part of the Works by the Employer's Personnel or by others for whom the Employer is responsible.
<p>Clause-40/CC</p>	<p>The following paras are added to the Existing CC Clauses.</p> <p>CONTRACT PRICE</p> <p>40.1 The Contract Price</p> <p>Unless otherwise stated in the Special Conditions of Contract:</p> <ul style="list-style-type: none"> (a) the Contract Price shall be agreed or determined under Clause 35/PCC [Payment for Variation] and be subject to adjustments in accordance with the Contract; (b) the Contractor shall pay all taxes, duties and fees required to be paid by him under the Contract, and the Contract Price shall not be adjusted for any of these costs except as stated in Sub-Clause 34.7/PCC [Adjustments for Changes in Legislation]; (c) any quantities which may be set out in the Bill of Quantities or other Schedule are estimated quantities and are not to be taken as the actual and final quantities: <ul style="list-style-type: none"> (i) of the Works which the Contractor is required to execute, or (ii) for the purposes of New-Clause 7/PCC [Measurement and Evaluation]; and (d) the Contractor shall submit to the Engineer, within 28 days after the Commencement Date, a proposed breakdown of each lump sum price in the Schedules, if applicable. The Engineer may take account of the breakdown when preparing Payment Certificates, but shall not be bound by it. (e) It may be noted that in the event of the Contractor not making the due payments stated in sub-clause (b) above, and the concerned party puts up a claim with the Employer / Engineer, then the Employer / Engineer may make such payments and deduct the same from the sums due to the Contractor. <p>Change in Law</p> <p>Change in Law means the occurrence or coming into force of the following, at any time after the last Date of submission of tender:</p> <p>Any new Central and State Taxes, duties, cess, levies, which is imposed or any existing Central and State Taxes, duties, cess, levies & royalties are withdrawn after the due date of submission of tender and which impacts the performance of the contractor with increased cost or which results in extra financial gains to the contractor due to decreased cost in execution of contract. Such additional or reduced cost shall be certified by the Engineer after</p>

	<p>examining records provided by the contractor and shall be paid by or credited to the employer.</p> <p>However, change in the rate of any existing Central & State taxes (except GST), duties, cess, levies will not be considered as change in Law. Any risk of change in rate of existing Central and State Taxes (except GST), duties, cess, levies lies with and shall be borne by the Contractor.</p>				
<p>Clause 42/CC</p>	<p>The following paras are added to the Existing CC Clauses.</p> <p>Advance Payment:</p> <p>42.1 Mobilization Advance</p> <p>The Employer shall make payment, as an Interest bearing advance for mobilization, when the Contractor submits a guarantee in accordance with this Sub-Clause. The total advance payment, the number and timing of instalments (if more than one), and the applicable currencies and proportions, shall be as stated in the Contract Data.</p> <p>Unless and until the Employer receives this guarantee, or if the total advance payment is not stated in the Contract Data, this Sub-Clause shall not apply.</p> <p>The Engineer shall issue an interim payment certificate for the first installment of mobilisation advance after receiving an application for advance payment (under sub clause 37.1/PCC [Application for Interim Payment Certificates]) and after the Employer receives (i) the Performance Security in accordance with New-Clause 4.19/PCC [Performance Security] and (ii) a guarantee in amounts and currencies equal to the advance payment plus 10%. The next installment shall be released only when the contractor submits statement of having utilized the previous installment of mobilization advance and the Employer is satisfied that the utilization has been done in purposeful manner.</p> <p>Mobilization advance payment: Comprises of the percentage of Accepted Contract Amount payable in the currencies and proportions in which the Accepted Contract Amount is payable and in installments as mentioned below;</p> <table border="1" data-bbox="427 1308 1476 1480"> <thead> <tr> <th data-bbox="427 1308 1058 1359">Mobilisation Advance</th> <th data-bbox="1061 1308 1476 1359">Installments</th> </tr> </thead> <tbody> <tr> <td data-bbox="427 1364 1058 1480">As per request of the Contractor subject to a maximum of 5%</td> <td data-bbox="1061 1364 1476 1480">Two Equal</td> </tr> </tbody> </table> <p>Timing of Mobilization Advance Payment: First Installment within 21 (Twenty-one) days from the date of receipt of Bank guarantee acceptable to Employer.</p> <p>Second Installment shall be released only when the contractor submits statement of having utilized the First Installment of mobilization Advance and the Employer is satisfied that the utilization has been done in purposeful manner. This shall be released within 21 days from the date of receipt of Bank guarantee acceptable to the Employer.</p> <p>Interest on Advance Payment: At the rate of SBI MCLR+2% simple interest per annum on reducing balances</p> <p>42.2 Advance against Plant and Machinery</p> <p>This advance is payable in Indian Rupees/respective currencies as quoted in the Tender and accepted by the Employer against plant, equipment and machinery, provided the same have reached the site, or in the case of new items meant specifically for the works,</p>	Mobilisation Advance	Installments	As per request of the Contractor subject to a maximum of 5%	Two Equal
Mobilisation Advance	Installments				
As per request of the Contractor subject to a maximum of 5%	Two Equal				

firm purchase order has been placed and the invoices received. The plant and machinery shall be valued by the Engineer as follows:

(a) New items: 80% of purchase price

(b) Used items in working order: 80% of the depreciated value as assessed by the Engineer

(c) Items valued at less than Rs. 1,000,000 (Rs. One million) per unit: Not to be considered

The total advance for Plant and Machinery shall be limited to 5% of the Contract Price and will carry an interest rate of SBI MCLR +2% simple interest per annum on reducing balances. It will be paid against submission of Bank Guarantees for 110% of advance value for each stage of advance to be given by each member of the consortium/JV in proportion to their participation as per format given in section 10: Formats, from an Indian Schedule bank (excluding Cooperative Banks) or from a schedule Foreign Bank as defined in Section 2(e) of RBI Act 1934 read with Second Schedule. All bank Guarantees should be payable in Bangalore at the designated branch.

The Contractor should give an Undertaking that "No advance/loan has been taken against the subject plant & machinery from any other individual/financial institution/ organization etc." If a wrong/false undertaking is given, all the BGs can be forfeited and the contract is liable for termination under clause 49 of CC/PCC.

The Advance against Plant and Machinery will be paid within 30 days after receipt of the Contractor's written request by the Employer which is recommended by the Engineer and submission of Bank Guarantees for procurement of plant and machinery.

Wherever Bank Guarantee or any other instrument is to be extended or fresh BG to be obtained, the cost towards getting extension of BG or fresh BG and other incidental charges will be on Contractor's account

The Contractor;

(i) Shall submit the invoice and RC book (wherever applicable) in original, at the time of obtaining advance amount.

(ii) Shall furnish all four Bank Guarantees one time as per Condition of Contract.

(iii) Shall execute an Indemnity bond in favour of an Employer as against Third Party claim.

(iv) Shall not seek the possession of machinery brought to the site till the Advance obtained from Employer is fully settled.

The contractor should ensure that in the case of "Machinery and Equipment Advance" insurance and hypothecation in favour of the Employer should be done. The contractor should submit the proof of document related to Insurance and Hypothecation to the Engineer who will certify that the insurance and hypothecation to the Employer has been done in proper manner.

Employer shall be the sole custodian of the entire plant and machinery whenever the advance amount is given to the contractor and the same shall remain in the custody of Employer, till the Advance obtained from Employer, is fully settled.

The machinery and equipment brought to the site shall be exclusively intended for the execution of the work of Employer and shall not be removed without the consent of the Engineer.

The Contractor shall indemnify and hold harmless, the Employer against all actions, suits, proceedings, claims, damages, losses, expenses, demands pertaining to Advance amount towards plant and machinery.

The Contractor shall not remove any Equipment or Machinery from the site without the prior permission of the Engineer.

The contractor;

a) Shall not mortgage/create charge/hypothecate/encumber, in any way the machineries and equipment brought to site from the amounts advanced by Employer and shall give an undertaking in writing to that effect in favour of Employer.

b) Shall not sell or alienate any part/portion of machinery and equipment without the consent of Employer.

c) In the event of any such sale/alienation of any portion or part of machinery, Employer shall hold First Charge and the proceeds of such sale or alienation shall be appropriated towards the loan/ credit/ advance in respect of plant and machinery brought to the site by contractor.

42.3 Guarantees

Advances as mentioned in sub-clauses 42.1/PCC above, shall be payable against acceptable Bank Guarantees from banks as specified in New-clause 4.19/PCC. The guarantees shall be in the form as given in Section 10 (Contract Forms) or in another form approved by the Employer. The Contractor shall ensure that the guarantees are valid and enforceable until the advance amount paid as has been repaid, but its amount may be progressively reduced by the amount repaid by the Contractor as indicated in the Payment Certificates. If the terms of the guarantee specify its expiry date, and the advance payment has not been repaid by the date 28 days prior to the expiry date, the Contractor shall extend the validity of the guarantee until the advance payment has been repaid.

42.4 Recovery of Advances

Unless stated otherwise in the Contract Data, the advance payment shall be repaid through percentage deductions from the interim payments determined by the Engineer in accordance with Sub-Clause 37.3/PCC [Issue of Interim Payment Certificates], as follows:

- (a) deductions shall commence in the next interim Payment Certificate following that in which the total of all certified interim payments (excluding the advance payment) exceeds 15 percent of the Accepted Contract Amount Less Provisional Sums or passage of six months from the date of release of first advance payment, whichever is earlier; and

	<p>(b) deductions shall be made for accrued interest on the advance up to the month and advance at the rate stated in the Contract Data of the amount of each Interim Payment Certificate (excluding the advance payment and deductions and repayments of retention) in the currencies and proportions of the advance payment until such time as the advance payment and accrued interest has been repaid; provided that the advance payment and accrued interest shall be completely repaid prior to the time when 85 percent of the Accepted Contract Amount has been certified for payment. If the amount of interim payment certificate is not sufficient for recovery of accrued interest or in the opinion of the Employer satisfactory progress is not being achieved by the contractor, then the contractor will have to deposit the accrued interest and return the mobilisation advance in part or in full as demanded by the Employer, failing which Employer shall have the right to encash the Bank Guarantee(s)</p> <p>The contractor shall always have the option to start repayment earlier and/or to complete the repayment earlier than the due date.</p> <p>If the advance payment has not been repaid prior to the issue of the Taking-Over Certificate for the Works or prior to termination under Clause 49.0/PCC [Termination by Employer] or New-Clause 8/PCC [Force Majeure] (as the case may be), the whole of the balance then outstanding shall immediately become due and payable by the Contractor to the Employer.</p> <p>42.5 Repayment rate of Advance payment: 10% (Ten percent) of the amount of each running account bill payment.</p> <p>42.6 Advances to be Used only for this Work</p> <p>The advances shall be used by the Contractor strictly for the purpose of the Contract, and for the purpose for which they are paid. Under no circumstances, shall the advances be diverted for other purposes. Any such diversion shall be construed as a breach of the Contract and the Contractor shall be asked to return the advance at once and pay interest at 15% per annum till the advance is recovered back from him. The Contractor shall return the advance and pay the interest in one go without demur.</p> <p>Employer retains the right for any other remedy prescribed for breach of Contract in this regard.</p> <p>The Contractor, if required by the Engineer shall provide the details of utilisation of Mobilisation advance.</p>
<p>Clause 46/CC</p>	<p>The clause 46 of CC replaced with the following paras.</p> <p>Employer Taking Over</p> <p>46.1 Taking Over of the Works and Sections</p> <p>The Employer shall take over the Site and the Works within after issuing a certificate of Completion. Except as stated in Sub-Clause 30.5/PCC [Failure to Pass Tests on Completion], the Works shall be taken over by the Employer/Railway when (i) the Works have been completed in accordance with the Contract, including the matters described in Sub-Clause 26.4/PCC [Time for Completion] and except as allowed in sub-paragraph (a) below, and (ii) a Taking-Over Certificate for the Works has been issued, or is deemed to have been issued in accordance with this Sub-Clause.</p> <p>The Contractor may apply by notice to the Engineer for a Taking-Over Certificate not earlier than 14 days before the Works will, in the Contractor's opinion, be complete and ready for</p>

taking over. If the Works are divided into Sections, the Contractor may similarly apply for a Taking-Over Certificate for each Section.

In case the works are to be taken over in accordance with sub-clause 30.6/PCC, the completed works shall be taken over by the Zonal Railway with the procedure specified by the Engineer.

The Engineer shall, within 28 days after receiving the Contractor's application:

- (a) issue the Taking-Over Certificate to the Contractor, stating the date on which the Works or Section were completed in accordance with the Contract, except for any minor outstanding work and defects which will not substantially affect the use of the Works or Section for their intended purpose (either until or whilst this work is completed and these defects are remedied); or
- (b) reject the application, giving reasons and specifying the work required to be done by the Contractor to enable the Taking-Over Certificate to be issued. The Contractor shall then complete this work before issuing a further notice under this Sub-Clause.

If the Engineer fails either to issue the Taking-Over Certificate or to reject the Contractor's application within the period of 28 days, and if the Works or Section (as the case may be) are substantially in accordance with the Contract, the Taking-Over Certificate shall be deemed to have been issued on the last day of that period.

46.2 Taking Over of Parts of the Works

The Engineer may, at the sole discretion of the Employer, issue a Taking-Over Certificate for any part of the Permanent Works.

The Employer shall not use any part of the Works (other than as a temporary measure which is either specified in the Contract or agreed by both Parties) unless and until the Engineer has issued a Taking-Over Certificate for this part. However, if the Employer does use any part of the Works before the Taking-Over Certificate is issued:

- (a) the part which is used shall be deemed to have been taken over as from the date on which it is used,
- (b) the Contractor shall cease to be liable for the care of such part as from this date, when responsibility shall pass to the Employer, and
- (c) if requested by the Contractor, the Engineer shall issue a Taking-Over Certificate for this part.

After the Engineer has issued a Taking-Over Certificate for a part of the Works, the Contractor shall be given the earliest opportunity to take such steps as may be necessary to carry out any outstanding Tests on Completion. The Contractor shall carry out these Tests on Completion as soon as practicable before the expiry date of the relevant Defects Notification Period.

If the Contractor incurs Cost as a result of the Employer taking over and/or using a part of the Works, other than such use as is specified in the Contract or agreed by the Contractor, the Contractor shall (i) give notice to the Engineer and (ii) be entitled subject to Sub-Clause 4.1/SCC [Contractor's Claims] to payment of any such Cost, which shall be included in the Contract Price. After receiving this notice, the Engineer shall proceed in accordance with New—Clause 3.5/PCC [Determinations] to agree or determine this Cost and profit.

If a Taking-Over Certificate has been issued for a part of the Works (other than a Section), the delay damages thereafter for completion of the remainder of the Works shall be

	<p>reduced. Similarly, the delay damages for the remainder of the Section (if any) in which this part is included shall also be reduced. For any period of delay after the date stated in this Taking-Over Certificate, the proportional reduction in these delay damages shall be calculated as the proportion which the value of the part so certified bears to the value of the Works or Section (as the case may be) as a whole. The Engineer shall proceed in accordance with New-Clause 3.5/PCC [Determinations] to agree or determine these proportions. The provisions of this paragraph shall only apply to the daily rate of delay damages under Sub-Clause 26.8/PCC [Delay Damages], and shall not affect the maximum amount of these damages</p> <p>46.3 Interference with Tests on Completion</p> <p>If the Contractor is prevented, for more than 14 days, from carrying out the Tests on Completion by a cause for which the Employer/Engineer/other Contractors of the Employer, are responsible, the Employer shall be deemed to have taken over the Works or Section (as the case may be) on the date when the Tests on Completion would otherwise have been completed.</p> <p>The Engineer shall then issue a Taking-Over Certificate accordingly, and the Contractor shall carry out the Tests on Completion as soon as practicable, before the expiry date of the Defects Notification Period. The Engineer shall require the Tests on Completion to be carried out by giving 14 days' notice and in accordance with the relevant provisions of the Contract.</p> <p>If the Contractor suffers delay and/or incurs Cost as a result of this delay in carrying out the Tests on Completion, the Contractor shall give notice to the Engineer and shall be entitled subject to Sub-Clause 4.1/SCC [Contractor's Claims] to:</p> <ul style="list-style-type: none"> (a) an extension of time for any such delay, if completion is or will be delayed, under Sub-Clause 26.5/PCC [Extension of Time for Completion], and (b) payment of any such Cost, which shall be included in the Contract Price. <p>After receiving this notice, the Engineer shall proceed in accordance with New-Clause 3.5/PCC [Determinations] to agree or determine these matters.</p> <p>46.4 Surfaces Requiring Reinstatement</p> <p>Except as otherwise stated in a Taking-Over Certificate, a certificate for a Section or part of the Works shall not be deemed to certify completion of any ground or other surfaces requiring reinstatement.</p>
<p>Clause-49/CC</p>	<p>The following paras are added to the existing CC Clauses.</p> <p>TERMINATION BY EMPLOYER</p> <p>49.6 Notice to Correct</p> <p>If the Contractor fails to carry out any obligation under the Contract as mentioned below, but not limited to the obligations mentioned herein below, the Engineer/ Employer may serve the contractor with a 14 days' notice in writing calling upon the Contractor to make good the failure and to remedy it. If the Contractor;</p> <ul style="list-style-type: none"> (a) fails to comply with New-Clause 4.19/PCC [Performance Security], (b) abandons the Works or otherwise plainly demonstrates the intention not to continue performance of his obligations under the Contract,

- (c) without reasonable excuse fails to:
- (i) proceed with the Works in accordance with Clause 26/CC/PCC [Commencement, Delays and Suspension], or
 - (ii) comply with a notice issued under New-Clause 5.5 [Rejection] or New-Clause 5.6/PCC [Remedial Work], within 28 days after receiving it, or
 - (iii) adhere to the agreed programme of work / activity on the critical path, by a margin of 10% of the stipulated period, or
 - (iv) take steps to deploy competent and adequate number of personnel, and equipment to achieve progress as per agreed programme or
 - (v) adhere to the instructions of Engineers/Employer persistently or
 - (vi) comply any provision of the contract or
 - (vii) provide the Engineer/Employer or their representative proper facilities for inspecting the works or any part thereof as required, under New-Clause 5.3/PCC (Inspection) and New-clause 5.4/PCC (Testing).

- (d) subcontracts the whole or major part of the Works or assigns the Contract without prior written consent of the Employer.,

If the Contractor does not, within 14 days of receipt of notice under this sub-clause, proceed to make good his default in so far as the same is capable of being made good and carry on the work of complying with such direction as contained in the notice under sub clause 49.6/PCC to the entire satisfaction of the Engineer/Employer, the Employer shall be entitled to take action under sub-clause 49.6/PCC, 49.7/PCC below,

In case of Contractor's repeated failure to adhere to the agreed program, and whereas the contractor has been served with a Notice to Correct under Clause 49.6 of PCC, if the Contractor approaches K-RIDE with a revised program with specific monthly physical and financial targets along with the proposal to deploy matching inputs in the form of manpower and other resources to the satisfaction of the Employer, then the Employer may consider whether to proceed with termination of the contract under Clause 49.7/PCC or to continue with the contract. However, the request to continue with the contract shall only be considered if the Contractor supports his earnestness to adhere to the revised program by submitting additional Performance Security in the form of Bank Guarantee(s) of specified number and value as decided by the Employer (total value of which will not exceed 10% of the contract price). The encashment of these additional Bank Guarantee(s) shall be linked with the non-achievement of agreed physical/financial targets agreed upon by the Contractor and the Employer.

In case the Contractor's failure is limited to only some of the works, and in response to Notice to Correct under Clause 49.6 of PCC, the contractor approaches the Employer that such works may be offloaded from him and got executed through another agency and additional cost incurred, if any, should be recovered from his dues, the Employer, on being convinced that the anticipated additional cost for such works will not be substantial and can be recovered from the dues of the contractor and that such offloading will help in improving the overall progress of the project, may

agree to such offloading without any repercussion on the performance security and/or additional bank guarantees, if any, submitted by the contractor. However, the Employer will

not be under any compulsion to agree to such a request. The Contractor shall be informed of the LOA issued to other agency(ies) for such works.

In case the Contractor does not approach the employer for offloading but the Employer is convinced that:

- (i) offloading of some works will help in improving the progress of the project;
- (ii) termination/part termination of the contract at this stage will not be in the interest of the project;
- (iii) the anticipated additional cost for such works will not be substantial and can be recovered from the dues of the Contractor;

The Employer may issue 7 days' notice to the Contractor stating the resources required to be deployed against each work. If the Contractor fails to deploy the required resources as indicated in the notice, the employer shall offload such works and proceed with getting the works executed through other agency(ies). The Contractor shall be informed of the LOA issued to other agency(ies) for such works.

Offloading under the sub clause 49.6/PCC shall be without any repercussion on the performance security and/or additional bank guarantees, if any, submitted by the contractor. The Contractor would have no future claim on this account and the extra expenditure so incurred, if any, by the Employer in getting the offloaded work done, shall be recovered from subsequent payment certificates or any other dues of the Contractor

49.7 Termination by Employer

The Employer shall be entitled to terminate the Contract as a whole or any part or parts (as may be specified in the Notice of Termination under any of the above Sub-Clause issue) if the Contractor:

- (a) fails to comply with the directions contained in the notice under Sub-Clause 49.6/PCC [Notice to Correct],
- (b) becomes bankrupt or insolvent, goes into liquidation, has a receiving or administration order made against it by Court or Statutory Authority him, compounds with his creditors, or carries on business under a receiver, trustee or manager for the benefit of his creditors, or if any act is done or event occurs which (under applicable Laws) has a similar effect to any of these acts or events, or
- (c) gives or offers to give (directly or indirectly) to any person any bribe, gift, gratuity, commission or other thing of value, as an inducement or reward:
 - (i) for doing or forbearing to do any action in relation to the Contract, or
 - (ii) for showing or forbearing to show favour or disfavour to any person in relation to the Contract,

or if any of the Contractor's Personnel, agents or Subcontractors gives or offers to give (directly or indirectly) to any person any such inducement or reward as is described in this sub-paragraph (c). However, lawful inducements and rewards to Contractor's Personnel shall not entitle termination

In any of these events or circumstances, the Employer may, by Notice Terminate the contract with immediate effect.

The Employer's election to terminate the Contract shall not prejudice any other rights of the Employer, under the Contract or otherwise.

The Contractor shall remove all his plants and machinery from the site then leave the Site and deliver any required Goods, all Contractors' Documents, and other design documents made by or for him, to the Engineer within 7 days from the issue of Notice of Termination, failing which Delay Damages as prescribed for delay in completion of works shall be imposed as per provision of clause 26.8/PCC However, the Contractor shall use his best efforts to comply immediately with any reasonable instructions included in the notice of Termination (i) for the assignment of any subcontract, and (ii) for the protection of life or property or for the safety of the Works.

After termination, the Employer may complete the Works and/or arrange for any other entities to do so. The Employer and these entities may then use any Goods, Contractor's Documents and other design documents made by or on behalf of the Contractor for completing the work.

49.8 Valuation at Date of Termination

As soon as practicable after a notice of termination under Sub-Clause 49.7/PCC [Termination by Employer] has taken effect, the Engineer shall proceed in accordance with Sub-Clause 3.5/PCC [Determinations] to agree or determine the value of the Works, Goods and Contractor's Documents, and any other sums due to the Contractor for work executed in accordance with the Contract. For this purpose, the contractor shall be notified the date for witnessing of measurements and handing over of the materials for which contractor has already been paid. In case the contractor fails to attend or send a representative even after such notice, the Engineer shall ex parte proceed with measurements of the works executed and taking over of plants and materials etc. for which payment has already been made to the contractor, which shall be treated as final.

49.9 Payment after Termination

After a notice of termination under Sub-Clause 49.7/PCC [Termination by Employer] has taken effect, the Employer may:

- (a) proceed in accordance with New-Clause 2.4/PCC [Employer's Claims],
- (b) encash the Performance Guarantee and forfeit the Performance Security:
 - i. In full including additional Performance Guarantee amount if any taken in terms of ITT and not due for release on the date of issue of termination letter, in case of termination of the contract as a whole; or
 - ii. in part/parts proportionate to the contract price of the bill/schedule to which the terminated part of work belongs i.e.

$P = (A \times B) \div C$ where,

P = Proportionate Bank Guarantee Amount

A = Contract Price of the particular bill/schedule to which the terminated part of work belongs

B = Performance Guarantee amount in terms of CC New- clause 4.19/PCC

C = Total Contract Price

Plus, additional Performance Guarantee amount if any taken in terms of ITT and not due for release on the date of issue of termination letter against that particular

bill/Schedule to which the terminated part of the work belongs in case of termination in part/parts.

- (c) release any payment due to the contractor for works executed prior to termination and evaluation under clause 49.8/PCC (valuation at date of termination, however, if by this time the Contractor has failed to make a payment due to the Employer, the same will be deducted from the payment due and any balance remaining shall then be paid to the Contractor.)

49.10 Employer's Entitlement to Termination for Convenience

The Employer shall be entitled to terminate the Contract, at any time for the Employer's convenience, by giving notice of such termination to the Contractor. The termination shall take effect 28 days after the later of the dates on which the Contractor receives this notice or the Employer returns the Performance Security. The Employer shall not terminate the Contract under this Sub-Clause in order to execute the Works himself or to arrange for the Works to be executed by another contractor or to avoid a termination of the Contract by the Contractor.

After this termination, the Contractor shall proceed in accordance with the relevant clause and shall be paid in accordance with New-Clause 8/PCC [Payment and Release in case of Optional Termination].

49.11 Payment on Termination

After termination under Sub-Clause-49.7/PCC the Employer shall return the Performance Security, and shall pay the Contractor an amount calculated and certified in accordance with the following conditions:

- A. The value of approved materials actually brought to the site and reasonably required to execute the works during next three months, as per approved programme, and
- B. Value of work completed up to date by the Contractor at rates specified in the Contract, after taking into account any deductions, retentions, and setoff.

C. **DELETED**

The payment as above are full compensation for termination under this clause and the Contractor has no claim for damages or other entitlements whether under the contract or otherwise.

In case of termination/ foreclosure of the Contract under whatsoever circumstances, any remaining tools, plants, equipment's and surplus materials of the Employer with the Contractor will be returned to the Employer at Employer's depot at the Contractor's cost. In case of the failure of the Contractor to do so, the Employer will be entitled to recover their cost from the Contractor from the amount becoming due to the Contractor or from any other amount due in any other contracts.

The decision of the Engineer of the amount to be recovered will be final decision and full credit at rates initially charged to the Contractor shall be allowed for such materials. Similarly, the Employer shall be entitled to recover the cost of the unreturned material, plants, equipment and tools from the Contractor, where such material have been supplied free of cost and plants, equipment and tools, free of cost or on lease basis to the Contractor as stipulated in the Contract.

49.12 Survival

Termination of this Contract

	<p>a. shall not relieve the Contractor or the Employer of any obligations already incurred hereunder which expressly or by implication survives Termination hereof and</p> <p>b. except as otherwise provided in any provision of this Contract expressly limiting the liability of either party, shall not relieve either party of any obligations or liabilities for loss or damage to the other Party arising out of or caused by acts or omissions of such Party prior to the effectiveness of such Termination or arising out of such Termination</p> <p>49.13 Corrupt or Fraudulent Practices</p> <p>If the Employer determines that the Contractor has engaged in corrupt, fraudulent, collusive or coercive practices, in competing for or in executing the Contract, then the Employer may, after giving 14 days' notice to the Contractor, terminate the Contractor's employment under the Contract and expel him from the Site, and the provisions of Clause 49 CC/PCC shall apply as if such expulsion had been made under Sub-Clause 49.7/PCC.</p> <p>For the purposes of this Sub-Clause:</p> <p>(a) "corrupt practice" means the offering, giving, receiving or soliciting of anything of "value to influence the action of a public official in the procurement process or in the Contract execution.</p> <p>(b) "fraudulent practice" means a misrepresentation of facts in order to influence a procurement process or the execution of the Contract to the detriment of the Employer, and includes collusive practice among Bidders (prior to or after bid submission) designed to establish bid prices at artificial non-competitive levels and to deprive the Employer of the benefits of free and open competition</p> <p>(c) "collusive practice" means a scheme or arrangement between two or more bidders, with or without the knowledge of the Employer, designed to establish bid prices at artificial, non-competitive levels.</p> <p>(d) "coercive practice" means harming or threatening to harm, directly or indirectly, persons or their property to influence their participation in the procurement process or affect the execution of a contract.</p>
<p>Clause 1/SCC</p>	<p>The following New-paras are added to the Existing SCC Clauses.</p> <p>1.1 Engagement of Staff and Labour</p> <p>Except as otherwise stated in the Specification, the Contractor shall make arrangements for the engagement of all staff and labour, local or otherwise, and for their payment, housing, feeding and transport.</p> <p>The Contractor is encouraged, to the extent practicable and reasonable, to employ staff and labor with appropriate qualifications and experience from sources within the Country.</p> <p>1.2 Rates of Wages and Conditions of Labour</p> <p>The Contractor shall pay rates of wages, and observe conditions of labour, which are not lower than those established for the trade or industry where the work is carried out. If no established rates or conditions are applicable, the Contractor shall pay rates of wages and observe conditions which are not lower than the general level of wages and conditions observed locally by employers whose trade or industry is similar to that of the Contractor.</p> <p>If the Employer is obliged to provide amenities or arrange payment of wages to contract labour employed by the contractor either directly or through sub-contractor under the contract on account of failures on the part the contractor to provide the amenities and / or arrange payment of wages to the contract labour as required of him under the provision of</p>

the applicable acts / rules made there under, the Engineer/Employer shall be at liberty without prejudice to the rights of Engineer/Employer under Section 20(2) and 21(4) of the Contract Labour (Regulation and Abolition) Act 1970 to recover the whole or part of the expenditure so incurred on the wages so paid by the Engineer/Employer/Railway from the security deposit and/or from any sum or sums due to the Contractor whether under this contract or any other contract.

The Contractor shall inform the Contractor's Personnel about their liability to pay personal income taxes in the Country in respect of such of their salaries, wages, allowances, and any benefits as are subject to taxes under the Laws of the Country for the time being in force, and the Contractor shall perform such duties in regard to such deductions thereof as may be imposed on him by such Laws.

The Contractor shall keep the Employer indemnified in case any action is taken against the Employer by the competent authority on account of contravention of any of the provisions of any Act or rules made there-under, regulation or notifications including amendment. If the Employer is caused to pay or reimburse, such amounts as may be necessary to cause or observe, or for non-observance of the provisions stipulated in the notifications/bye laws/Acts/Rules/ regulations including amendments, if any, on the part of the Contractor, the Engineer/Employer shall have the right to deduct any money due to the contractor including his amount of performance security. The Employer/Engineer shall also have right to recover from the Contractor any sum required or estimated to be required for making good the loss or damage suffered by the Employer.

The employees of the Contractor and the Sub-Contractor in no case shall be treated as the employees of the Employer at any point of time.

The Contractor shall duly comply with the provisions of the Apprentices Act 1961 (III of 1961), the rules made there under and the orders that may be issued from time to time under the said Act and the said Rules and on his failure or neglect to do so he shall be subject to all liabilities provide by the said Act and said Rules.

The Contractor and his Sub Contractors shall comply with all applicable Labour Laws, and should not employ Child Labour for construction and maintenance activities. The Contractor shall provide appropriate facilities for children in Construction Camp sites.

The Contractors shall not differentiate wages between men and women for work of equal value

1.3 Persons in the Service of Employer

The Contractor shall not recruit, or attempt to recruit, staff and labour from amongst persons in the service of the Employer or the Engineer

1.4 Labour Laws

The Contractor shall comply with all the relevant Labour Laws applicable to the Contractor's Personnel, including Laws relating to their employment, health, safety, welfare, immigration, and emigration, and shall allow them all their legal rights. The Contractor and his sub-contractors shall be responsible to ensure at his own cost, compliance to all laws, bye-laws, rules and regulations for the time being in force pertaining to the employment of local or imported labour and shall take all necessary precautions to ensure and preserve the health and safety of all staff employed directly or through sub-contractors or petty contractors on the works which shall include all the acts listed in Appendix – 1 but not limited to the same.

The Contractor shall require his employees to obey all applicable Laws, including those concerning safety at work.

During continuance of the Contract, the Contractor and his Sub-Contractors shall abide at all times by all existing labor enactments and rules made thereunder, regulations, notifications and bye laws of the State or Central government or local authority and any other labor laws (including rules), regulations, bye laws that may be passed or notification that may be issued under any labor law in future either by the State or the Central Government or the local authority. Salient features of some of the major labor laws that are applicable to construction industry are given in Appendix 1 to these Conditions of Contract

1.5 Working Hours

No work shall be carried out on the Site on locally recognized days of rest, or outside the normal working hours stated in the Contract Data, unless:

- (a) otherwise stated in the Contract,
- (b) the Engineer gives consent, or
- (c) the work is unavoidable, or necessary for the protection of life or property or for the safety of the Works, in which case the Contractor shall immediately advise the Engineer.
- (d) The Contractor, generally will have to carry out work during night hours also and in shifts unless specifically provided otherwise in the Contract. No increase in rates or extra payments shall be admissible for night work. Wherever night working is carried out by Contractor, temporary lighting arrangements as per approved layout shall be provided, installed, maintained for the duration of the contract and removed after completion of work. Flashing lights to warn the traffic on roads shall be used at all times on all obstructions. No extra payment will be made for the provision of temporary lighting, flashing lights and for maintenance. It is to be noted that the works are being undertaken in an urban area.
- (e) Should there be complaints received by members of the public regarding excessive noise or vibration, etc. especially at night, and if such complaints are valid, then the contractor shall take remedial measures to prevent such nuisance. No extra payment will be made to the contractor for the provision of such measures.
- (f) Working hours during the Defect liability period will be curtailed when certain system become operational

1.6 Facilities for Staff and Labour

Except as otherwise stated in the Specification, the Contractor shall provide and maintain all necessary accommodation and welfare facilities for the Contractor's Personnel. The Contractor shall also provide facilities for the Employer's Personnel as stated in the Specification.

The Contractor shall not permit any of the Contractor's Personnel to maintain any temporary or permanent living quarters within the structures forming part of the Permanent Works.

1.7 Health and Safety

The Contractor shall at all times take all reasonable precautions to maintain the health and safety of the Contractor's Personnel. In collaboration with local health authorities, the Contractor shall ensure that medical staff, first aid facilities, sick bay and a standing arrangement for ambulance service are available at a phone call at all times at the Site and at any accommodation for Contractor's and Employer's Personnel, and that suitable

arrangements are made for all necessary welfare and hygiene requirements and for the prevention of epidemics.

In the event of any outbreak of illness of an epidemic nature, the Contractor shall comply with and carry out such regulations, orders and requirements as may be made by the Government or the local medical or sanitary authorities, for the purpose of dealing with and overcoming the same. The Contractor shall appoint an accident prevention officer at the Site, responsible for maintaining safety and protection against accidents. This person shall be qualified for this responsibility, and shall have the authority to issue instructions and take protective measures to prevent accidents. Throughout the execution of the Works, the Contractor shall provide whatever is required by this person to exercise this responsibility and authority.

The Contractor shall send, to the Engineer, details of any accident as soon as practicable after its occurrence.

HIV-AIDS Prevention. The Contractor shall conduct an HIV-AIDS awareness programme via an approved service provider, and shall undertake such other measures as are specified in this Contract to reduce the risk of the transfer of the HIV virus between and among the Contractor's Personnel and the local community, to promote early diagnosis and to assist affected individuals

Epidemics

In the event of any outbreak of illness of an epidemic nature, the Contractor shall comply with and carry out such regulations, orders and requirements as may be made by the Government or the local medical or sanitary authorities, for the purpose of dealing with and overcoming the same.

Records of Safety and Health

The Contractor shall maintain such records and make such reports concerning safety, health and welfare of persons and damage to property as the Engineer may from time to time prescribe.

Submission of Returns

The contractor shall be responsible for timely submission of all returns and statements to the concerned authorities in full compliance of all rules, bye-laws and regulations for the time being in force.

The Contractor shall throughout the contract (including the Defects Notification Period): (i) conduct Information, Education and Consultation Communication (IEC) campaigns, at least every other month, addressed to all the Site staff and labor (including all the Contractor's employees, all Sub-Contractors and Consultants' employees, and all truck drivers and crew making deliveries to Site for construction activities) and to the immediate local communities, concerning the risks, dangers and impact, and appropriate avoidance behavior with respect to of Sexually Transmitted Diseases (STD)—or Sexually Transmitted Infections (STI) in general and HIV/AIDS in particular; (ii) provide male or female condoms for all Site staff and labor as appropriate; and (iii) provide for STI and HIV/AIDS screening, diagnosis, counseling and referral to a dedicated national STI and HIV/AIDS program, (unless otherwise agreed) of all Site staff and labor.

The Contractor shall include in the program to be submitted for the execution of the Works under Sub-Clause 25.3 an alleviation program for Site staff and labour and their families in respect of Sexually Transmitted Infections (STI) and Sexually Transmitted Diseases (STD) including HIV/AIDS. The STI, STD and HIV/AIDS alleviation program shall indicate when,

how and at what cost the Contractor plans to satisfy the requirements of this Sub-Clause and the related specification. For each component, the program shall detail the resources to be provided or utilized and any related sub-contracting proposed. The program shall also include provision of a detailed cost estimate with supporting documentation. Payment to the Contractor for preparation and implementation this program shall not exceed the Provisional Sum dedicated for this purpose.

1.8 Contractor's Superintendence

Throughout the execution of the Works, and as long thereafter as is necessary to fulfil the Contractor's obligations, the Contractor shall provide all necessary superintendence to plan, arrange, direct, manage, inspect and test the work.

Superintendence shall be given by a sufficient number of persons having adequate knowledge of the language for communications (defined in Sub-Clause 3/CC [Law and Language]) and of the operations to be carried out (including the methods and techniques required, the hazards likely to be encountered and methods of preventing accidents), for the satisfactory and safe execution of the Works.

The Contractor shall employ the key personnel named in the Schedule of Personnel as referred to in the Contract Data to carry out the functions stated in the Schedule or other personnel approved by the Engineer. The Engineer will approve any proposed replacement of key personnel only if their qualifications, abilities and relevant experience are substantially equal to or better than those of the personnel listed in the Schedule.

The Contractor shall not employ any retired government Gazetted officer, who has either not completed one year after the date of retirement, or has not obtained permission to employment with the Contractor

1.9 Contractor's Personnel

The Contractor's Personnel shall be appropriately qualified, skilled and experienced in their respective trades or occupations. The Engineer may require the Contractor to remove (or cause to be removed) any person employed on the Site or Works, including the Contractor's Representative if applicable, who:

- (a) persists in any misconduct or lack of care,
- (b) carries out duties incompetently or negligently,
- (c) fails to conform with any provisions of the Contract, or
- (d) persists in any conduct which is prejudicial to safety, health, or the protection of the environment.

If the Engineer asks the Contractor to remove a person who is a member of the Contractor's staff or his work force stating the reasons, the Contractor shall ensure that the person leaves the Site within seven (7) days and has no further connection with the work in the Contract. The replacement person shall be appointed within fourteen (14) days of the notification by the Engineer.

A reasonable proportion of the Contractor's Superintending Staff shall have a working knowledge of the English language or the Contractor shall have available on site at all times

a sufficient number of competent interpreters to ensure the proper transmission of instructions and information. If appropriate, the Contractor shall then appoint (or cause to be appointed) a suitable replacement person

1.10 Records of Contractor's Personnel and Equipment

The Contractor shall submit, to the Engineer, details showing the number of each class of Contractor's Personnel and of each type of Contractor's Equipment on the Site. Details shall be submitted each calendar month, in a form approved by the Engineer, until the Contractor has completed all work which is known to be outstanding at the completion date stated in the Taking-Over Certificate for the Works

1.11 Disorderly Conduct

The Contractor shall at all times take all reasonable precautions to prevent any unlawful, riotous or disorderly conduct by or amongst the Contractor's Personnel, and to preserve peace and protection of persons and property on and near the Site

1.12 Foreign Personnel

The Contractor may bring in to the country any foreign personnel who are necessary for the execution of the Works to the extent allowed by the applicable Laws. The Contractor shall ensure that these personnel are provided with the required residence visas and work permits. The Employer will, without any financial liability, if requested by the Contractor, use his best endeavours in a timely and expeditious manner to assist the Contractor in obtaining any local, state, national, or government permission required for bringing in the Contractor's personnel.

The Contractor shall be responsible for the return of these personnel to the place where they were recruited or to their domicile. In the event of the death in the Country of any of these personnel or members of their families, the Contractor shall similarly be responsible for making the appropriate arrangements for their return or burial. Contractor shall also be responsible for any legal liabilities during their stay.

1.13 Supply of Foodstuffs

The Contractor shall arrange for the provision of a sufficient supply of suitable food as may be stated in the Specification at reasonable prices for the Contractor's Personnel for the purposes of or in connection with the Contract

1.14 Supply of Water

The Contractor shall, having regard to local conditions, provide on the Site an adequate supply of drinking and other water for the use of the Contractor's Personnel

1.15 Measures against Insect and Pest Nuisance

The Contractor shall at all times take the necessary precautions to protect the Contractor's Personnel employed on the Site from insect and pest nuisance, and to reduce their danger to health. The Contractor shall comply with all the regulations of the local health authorities, including use of appropriate insecticide

The Contractor shall provide his staff and labour with suitable prophylactics for the prevention of malaria, and take steps to prevent the formation of stagnant pools of water. He shall comply with all the regulations of the local health authorities in these respects and shall in particular arrange to spray thoroughly with approved insecticides all buildings erected on the site such treatment shall be carried out at least once a year or as instructed by the Engineer. The Contractor shall warn his staff and labour of the dangers of diseases

like Malaria, Filaria and other contagious diseases etc. and also regarding, Scorpions, Snakes, Wild animals etc. and preventive actions required to be taken by the labour and staff.

1.16 Alcoholic Liquor or Drugs

The Contractor shall not, otherwise than in accordance with the Laws of the Country, import, sell, give barter or otherwise dispose of any alcoholic liquor or drugs, or permit or allow importation, sale, gift barter or disposal thereto by Contractor's Personnel.

1.17 Arms and Ammunition

The Contractor shall not give, barter, or otherwise dispose of, to any person, any arms or ammunition of any kind, or allow Contractor's Personnel to do so.

1.18 Festivals and Religious Customs

The Contractor shall respect the Country's recognized festivals, days of rest and religious or other customs

1.19 Funeral Arrangements

The Contractor shall be responsible, to the extent required by local regulations, for making any funeral arrangements for any of his local employees who may die while engaged upon the Works.

1.20 Prohibition of Forced or Compulsory Labour

The contractor shall not employ "forced or compulsory labour" in any form. "Forced or compulsory labour" consists of all work or service, not voluntarily performed, that is extracted from an individual under threat of force or penalty.

1.21 Prohibition of Harmful Child Labour

The Contractor shall not employ any child to perform any work that is economically exploitative, or is likely to be hazardous to, or to interfere with, the child's education, or to be harmful to the child's health or physical, mental, spiritual, moral, or social development.

1.22 Employment Records of Workers

The Contractor shall keep complete and accurate records of the employment of labour at the Site. The records shall include the names, ages, genders, hours worked and wages paid to all workers. These records shall be summarized on a monthly basis and shall be available for inspection by the Engineer during normal working hours. These records shall be included in the details to be submitted by the Contractor under Sub-Clause 1.10/SCC of PCC [Records of Contractor's Personnel and Equipment].

In addition to the above, the Contractor shall register his firm/company etc. on website 'www.shramikkalyan.indianrailways.gov.in' and upload requisite details of labour and their payment in this portal. These details shall be available in public domain. The Registration/ updation on Portal shall be done as under:

- (a) Contractor shall apply for onetime registration of his company/firm etc. in the Shramikkalyan portal with requisite details subsequent to issue of Letter of Acceptance. Employer/Engineer shall approve the contractor's registration in the portal within 7 days of receipt of such request.

	<p>(b) Contractor once approved by any Employer/Engineer, can create password with login ID (PAN No.) for subsequent use of portal for all LoAs issued in his favour.</p> <p>(c) The contractor once registered on the portal, shall provide details of his Letter of Acceptances (LoA) / Contract Agreements on shramikkalyan portal within 15 days of issue of any LoA for approval of concerned Employer/Engineer. Employer/Engineer shall update (if required) and approve the details of LoA filled by contractor within 7 days of receipt of such request.</p> <p>(d) After approval of LoA by Employer/Engineer, contractor shall fill the salient details of contract labours engaged in the contract and ensure updating of each wage payment to them on shramikkalyan portal on monthly basis.</p> <p>(e) It shall be mandatory upon the contractor to ensure correct and prompt uploading of all salient details of engaged contractual labour & payments made thereof after each wage period.</p> <p>While processing payment of any 'Interim Payment Certificate' or 'Final Payment Certificate' or release of 'Advances' or 'Performance Guarantee / Security deposit', contractor shall submit a certificate to the Engineer or Engineer's representatives that "I have uploaded the correct details of contract labours engaged in connection with this contract and payments made to them during the wage period in Railway's Shramikkalyan portal at 'www.shramikkalyan.indianrailways.gov.in' till ____Month, ____Year."</p>
<p>Clause Price adjustment/ Contract data</p>	<p><u>REPLACE THE SUB-CLAUSE OF PRICE ADJUSTMENT IN CONTRACT DATA WITH THE FOLLOWING:</u></p> <p>PRICE VARIATION CLAUSE (PVC) - DELETED</p>
<p>New Clause-1.1</p>	<p>Assignment</p> <p>Neither Party shall assign the whole or any part of the Contract or any benefit or interest in or under the Contract. However, either Party:</p> <ol style="list-style-type: none"> i. may assign the whole or any part with the prior agreement of the other Party, at the sole discretion of such other Party, and ii. may, as security in favour of a bank or financial institution, assign its right to any moneys due, or to become due, under the Contract.
<p>New Clause -1.2</p>	<p>Care and Supply of Documents</p> <p>The Specification and Drawings shall be in the custody and care of the Employer. Unless otherwise stated in the Contract, two copies of the Contract and of each subsequent Drawing shall be supplied to the Contractor, who may make or request further copies at the cost of the Contractor.</p> <p>Each of the Contractor's Documents shall be in the custody and care of the Contractor, unless and until taken over by the Employer. Unless otherwise stated in the Contract, the Contractor shall supply to the Engineer six copies of each of the Contractor's Documents.</p> <p>The Contractor shall keep, on the Site, a copy of the Contract, publications named in the Specification, the Contractor's Documents (if any), the Drawings and Variations and other communications given under the Contract. The Employer's Personnel shall have the right of access to all these documents at all reasonable times.</p>

	<p>If a Party becomes aware of an error or defect in a document which was prepared for use in executing the Works, the Party shall promptly give notice to the other Party of such error or defect.</p>
New Clause-1.3	<p>Delayed Drawings or Instructions</p> <p>The Contractor shall give notice to the Engineer whenever the Works are likely to be delayed or disrupted if any necessary drawing or instruction is not issued to the Contractor within a particular time, which shall be reasonable. The notice shall include details of the necessary drawing or instruction, details of why and by when it should be issued, and details of the nature and amount of the delay or disruption likely to be suffered if it is late. If the Contractor suffers delay and/or incurs Cost as a result of a failure of the Engineer to issue the notified drawing or instruction within a time which is reasonable and is specified in the notice with supporting details, the Contractor shall give a further notice to the Engineer and shall be entitled subject to Clause 4.1/SCC of contract conditions [Contractor's Claims] to:</p> <ul style="list-style-type: none"> (a) an extension of time for any such delay, if completion is or will be delayed, under Sub-Clause 26.5/PCC [Extension of Time for Completion], and (b) payment of any such Cost, which shall be included in the Contract Price. <p>After receiving this further notice, the Engineer shall proceed in accordance with New-Clause 3.5/PCC [Determinations] to agree or determine these matters.</p> <p>However, if and to the extent that the Engineer's failure was caused by any error or delay by the Contractor, including an error in, or delay in the submission of, any of the Contractor's Documents, the Contractor shall not be entitled to such extension of time, Cost or profit.</p>
New Clause-1.4	<p>Employer's Use of Contractor's Documents</p> <p>As between the Parties, the Contractor shall retain the copyright and other intellectual property rights in the Contractor's Documents and other design documents made by (or on behalf of) the Contractor.</p> <p>The Contractor shall be deemed (by signing the Contract) to give to the Employer a non-terminable transferable non-exclusive royalty-free licence to copy, use and communicate the Contractor's Documents, including making and using modifications of them. This licence shall:</p> <ul style="list-style-type: none"> (a) apply throughout the actual or intended working life (whichever is longer) of the relevant parts of the Works, (b) entitle any person in proper possession of the relevant part of the Works to copy, use and communicate the Contractor's Documents for the purposes of completing, operating, maintaining, altering, adjusting, repairing and demolishing the Works, and (c) in the case of Contractor's Documents which are in the form of computer programs and other software, permit their use on any computer on the Site and other places as envisaged by the Contract, including replacements of any computers supplied by the Contractor. <p>The Contractor's Documents and other design documents made by (or on behalf of) the Contractor shall not, without the Contractor's consent, be used, copied or communicated to a third party by (or on behalf of) the Employer for purposes other than those permitted under this Sub-Clause.</p>
New Clause-1.5	<p>Contractor's Use of Employer's Documents</p>

	<p>As between the Parties, the Employer shall retain the copyright and other intellectual property rights in the Specification, the Drawings and other documents made by (or on behalf of) the Employer. The Contractor may, at his cost, copy, use, and obtain communication of these documents for the purposes of the Contract. They shall not, without the Employer's consent, be copied, used or communicated to a third party by the Contractor, except as necessary for the purposes of the Contract.</p>
New Clause-1.6	<p>Confidential Details</p> <p>The Contractor shall disclose all such confidential and other information as the Engineer may reasonably require in order to verify the Contractor's compliance with the Contract.</p> <p>The Contractor shall treat the details of the Contract as private and confidential, except to the extent necessary to carry out the Contractor's obligations under the Contract or to comply with applicable Laws. The Contractor shall not publish or disclose any particulars of the Works without the previous agreement of the Employer. However, the Contractor shall be permitted to disclose any publicly available information, or information otherwise required to establish his qualifications to compete for other projects.</p>
New Clause-1.7	<p>Compliance with Laws</p> <p>The Contractor shall, in performing the Contract, comply with applicable Laws. Unless otherwise stated in the Special Conditions of Contract:</p> <ul style="list-style-type: none"> (a) the Employer shall have obtained (or shall obtain) the planning, zoning or similar permission for the Permanent Works, and any other permissions described in the Specification as having been (or being) obtained by the Employer; and the Employer shall indemnify and hold the Contractor harmless against and from the consequences of any failure to do so; and (b) the Contractor shall give all notices, pay all taxes, duties and fees, and obtain all permits, licences and approvals, as required by the Laws in relation to the execution and completion of the Works and the remedying of any defects; and the Contractor shall indemnify and hold the Employer harmless against and from the consequences of any failure to do so.
New Clause-1.8	<p>Joint Venture - Joint and Several Liability</p> <p>If the Contractor constitutes (under applicable Laws) a joint venture of two or more persons/firms:</p> <ul style="list-style-type: none"> (a) these persons shall be deemed to be jointly and severally liable to the Employer for the performance of the Contract; (b) these persons shall notify the Employer of their leader who shall have authority to bind the Contractor and each of these persons; and (c) the Contractor shall not alter its composition or legal status without the prior consent of the Employer. (d) In the event of default by any partner of joint venture, on or after achieving 25% of the financial progress (excluding advance if any) the lead partner or remaining partner(s), in case the defaulting partner is the lead partner, shall notify the Employer within twenty eight (28) days of the occurrence and within Fifty six (56) days of the said notification, the lead partner or remaining partner(s), who are not the defaulting partner, shall assign the works of the defaulting partner, to equally competent party with prior consent of the Employer. For this purpose the term "equally competent party" shall mean as under:

	<p>“The new JV partner replacing the defaulting partner should meet the EQC requirement of package/combination of packages which was met by the defaulting partner on the basis of which the original tender was awarded.”</p> <p>The replacement of any defaulting partner, with the new partner shall be subject to the condition that the new partner has to submit additional performance security equal to 10% of balance cost of work of the JV partner being replaced. The performance security submitted by the defaulting partner shall also continue with K-RIDE till satisfactory completion of the work.</p> <p>(e) Notwithstanding the consent of the Employer for change in composition or legal status of the joint venture the partners shall continue to be jointly and severally liable to the Employer.</p> <p>(f) The joint venture shall enter into a joint venture agreement incorporating the provisions of sub-paras (a) to (e) based upon the form annexed to the Conditions of Contract. The JV agreement shall indicate precisely the specific role of all members of the JV in respect of planning, design, construction equipment, key personnel, work execution, and financing of the project. The authority to sign the agreement shall be evidenced by approved legal instruments.</p> <p>Notwithstanding the contents of the sub-clauses above, if the performance of any JV partner is not found satisfactory by the Employer, in respect of the responsibilities assigned to him as per JV agreement which is a part of this agreement, the Employer may issue notice of such default to the said JV partner or the JV (depending upon reasons of default) and declare the said JV partner or the JV as Poor Performer. The issue of such notice shall automatically debar the JV partner or JV as the case may be from participating in any K-RIDE tender from the date of issue of notice of default.</p>
<p>New Clause-1.9</p>	<p>Inspections by the Employer</p> <p>The Contractor shall permit the Employer and/or persons appointed by the Employer to inspect the Site and/or the Contractor’s records relating to the performance of the Contract.</p>
<p>New Clause-1.10</p>	<p>Bidder’s Credentials:</p> <p>The bidder shall submit an affidavit on a stamp paper to the effect that all the documents submitted by her along with her bid are true. This shall be mandatory all bids. The bid shall be summarily rejected if the bidder fails to submit this undertaking along with the bid.</p> <p>After opening the financial bid, the tender committee shall verify the credentials of the bidder who is declared as the lowest bidder (L1) for their authenticity. In case the credentials of L1 are not found to be in order, the bid shall be treated as technically unresponsive and thus invalid. The process shall be repeated for the next higher bidder till the valid L1 is established. If any document (or copy thereof) submitted by a bidder is found to be false/forged:</p> <p>a) The bidder/each partner/member of the bidding firm shall be liable to legal actions apart from punitive actions, as decided by competent authority of K-RIDE. In such an eventuality. The bid shall also be summarily rejected.</p> <p>b) If the contract has already been awarded, or Letter of Acceptance (LOA) has been issued and in the event of any failure to comply with the above, the contract shall be terminated, irrespective of the stage of progress in execution of the work. In such an eventuality, Security Deposit (SD), performance Guarantee (PG) and partial/full payments otherwise</p>

	<p>due to the contractor, in respect of the partial/full work executed by the contractor, shall be forfeited by the K-RIDE.</p> <p>c) Other punitive actions, like banning the bidder and partners/members of the bidding firm for future dealings with K-RIDE/Government of India/ Government of Karnataka may also be taken.</p>
	2. THE EMPLOYER
New Clause-2.1	<p>Permits, Licenses or Approvals</p> <p>The Employer shall (where he is in a position to do so) provide reasonable assistance to the Contractor at the request of the Contractor:</p> <p>(a) by obtaining copies of the Laws of the Country which are relevant to the Contract but are not readily available, and</p> <p>(b) for the Contractor's applications for any permits, licences or approvals required by the Laws of the Country:</p> <p>(i) which the Contractor is required to obtain under New-Clause 1.7/PCC [Compliance with Laws],</p> <p>(ii) for the delivery of Goods, including clearance through customs, and</p> <p>(iii) for the export of Contractor's Equipment when it is removed from the Site.</p>
New Clause -2.2	<p>Employer's Personnel</p> <p>The Employer shall be responsible for ensuring that the Employer's Personnel and the Employer's other contractors on the Site:</p> <p>(a) co-operate with the Contractor's efforts under New-Clause 4.24/PCC [Co-operation], and</p> <p>(b) take actions similar to those which the Contractor is required to take under sub-paragraphs (a), (b) and (c) of New-Clause 4.26/PCC [Safety Procedures] and under New-Clause 4.36/PCC [Protection of the Environment].</p>
New Clause-2.3	<p>Employer's Financial Arrangements</p> <p>The Employer has sourced the funds to finance the project</p> <p>Assignment by the Employer</p> <p>The Employer shall be fully entitled without the consent of the Contractor, to assign the benefit of the Contract or any part thereof and any interest therein or there under to any third party.</p>
New Clause-2.4	<p>Employer's Claims</p> <p>If the Employer considers himself to be entitled to any payment under any Clause of these Conditions or otherwise in connection with the Contract, and/or to any extension of the Defects Notification Period, the Employer or the Engineer shall give notice and particulars to the Contractor. However, notice is not required for payments due under New-Clause 4.37/PCC [Electricity, Water and Gas], under New-Clause 4.38/PCC [Employer's Equipment and Free-Issue Material], or for other services requested by the Contractor.</p> <p>The notice shall be given as soon as practicable after the Employer became aware, or should have become aware, of the event or circumstances giving rise to the claim. A notice relating to any extension of the Defects Notification Period shall be given before the expiry of such period.</p> <p>The particulars shall specify the Clause or other basis of the claim, and shall include substantiation of the amount and/or extension to which the Employer considers himself to be</p>

	<p>entitled in connection with the Contract. The Engineer shall then proceed in accordance with New-Clause 3.5/PCC [Determinations] to agree or determine (i) the amount (if any) which the Employer is entitled to be paid by the Contractor, and/or (ii) the extension (if any) of the Defects Notification Period in accordance with New-Clause 6.3/[PCC Extension of Defects Notification Period].</p> <p>This amount may be included as a deduction in the Contract Price and Payment Certificates. The Employer shall only be entitled to set off against or make any deduction from an amount certified in a Payment Certificate, or to otherwise claim against the Contractor, in accordance with this Sub-Clause.</p>
	<p>3.THE ENGINEER</p>
<p>New Clause-3.1</p>	<p>Engineer's Duties and Authority</p> <p>The Employer shall appoint the Engineer who shall carry out the duties assigned to him in the Contract. The Engineer's staff shall include suitably qualified engineers and other professionals who are competent to carry out these duties.</p> <p>The Engineer shall have no authority to amend the Contract.</p> <p>The Engineer may exercise the authority attributable to the Engineer as specified in or necessarily to be implied from the Contract.</p> <p>However, the Engineer shall obtain the specific approval of the Employer before taking action under the-following Sub-Clauses of these Conditions:</p> <ol style="list-style-type: none"> a) New-Clause 4.30/PCC [Unforeseeable Physical Conditions] Agreeing or determining an extension of time and/or additional cost. b) Sub-Clause 26.5/PCC [Extension of Time for Completion] Agreeing or determining extension of time. c) New-Clause 6.9/PCC [Performance Certificate] Issue of Performance Certificate. d) Sub-Clause 34. Except, <ol style="list-style-type: none"> i) in an emergency situation as determined by the Engineer and as amplified in sub-paras (h) and (i) below, or ii) DELETED e) Sub-Clause 34.3 -Variation Procedure: Approving a proposal for Variation submitted by the Contractor in accordance with Sub Clause 34.1 or 34.2. f) Sub-Clause 34.4 -Payment in applicable Currencies: Specifying the amount payable in each of the applicable currencies for a Variation. g) Clause 4.1/SCC: Contractor Claims for extension of time and/or additional payment. h) DELETED i) DELETED <p>Notwithstanding the obligation, as set out above, to obtain approval, if, in the opinion of the Engineer, an emergency occurs affecting the safety of life or of the Works or of adjoining property, he may, without relieving the Contractor of any of his duties and responsibility under the Contract, instruct the Contractor to execute all such work or to do all such things as may, in the opinion of the Engineer, be necessary to abate or reduce the risk. The Contractor shall forthwith comply, despite the absence of approval of the Employer, with any such instruction of</p>

	<p>the Engineer. The Engineer shall determine an addition to the Contract Price, in respect of such instruction, in accordance with Clause 34/PCC and shall notify the Contractor accordingly, with a copy to the Employer.</p> <p>i) In case the emergency mentioned in above Sub-paras occurs on account of failure of Contractor, by way of not adhering to the approved scheme of work or not taking adequate safety precautions or by any other reason attributable to the contractor, then no additional amounts shall be paid to the Contractor for attending to such emergencies and the Contractor shall be liable for Employer's claims.</p> <p>j) Clause7/PCC regarding deployment of Sub-Contractors.</p>
<p>New Clause-3.2</p>	<p>Delegation by the Engineer</p> <p>The Engineer may from time to time assign duties and delegate authority to assistants, and may also revoke such assignment or delegation. These assistants may include a resident engineer, and/or independent inspectors appointed to inspect and/or test items of Plant and/or Materials. The assignment, delegation or revocation shall be in writing and shall not take effect until copies have been received by both Parties.</p> <p>However, unless otherwise agreed by both Parties, the Engineer shall not delegate the authority to determine any matter in accordance with New-Clause 3.5/PCC [Determinations].</p> <p>Assistants shall be suitably qualified persons, who are competent to carry out these duties and exercise this authority, and who are fluent in the language for communications defined in Sub-Clause 3/CC [Law and Language].</p> <p>Each assistant, to whom duties have been assigned or authority has been delegated, shall only be authorised to issue instructions to the Contractor to the extent defined by the delegation. Any approval, check, certificate, consent, examination, inspection, instruction, notice, proposal, request, test, or similar act by an assistant, in accordance with the delegation, shall have the same effect as though the act had been an act of the Engineer. However:</p> <p>(a) any failure to disapprove any work, Plant or Materials shall not constitute approval, and shall therefore not prejudice the right of the Engineer to reject the work, Plant or Materials;</p> <p>(b) if the Contractor questions any determination or instruction of an assistant, the Contractor may refer the matter to the Engineer, who shall promptly confirm, reverse or vary the determination or instruction.</p>
<p>New Clause-3.3</p>	<p>Instructions of the Engineer</p> <p>The Engineer may issue to the Contractor (at any time) instructions and additional or modified Drawings which may be necessary for the execution of the Works and the remedying of any defects, all in accordance with the Contract. The Contractor shall only take instructions from the Engineer, or from an assistant to whom the appropriate authority has been delegated under this Clause. If an instruction constitutes a Variation, Clause34/PCC [Variations and Adjustments] shall apply.</p> <p>The Contractor shall comply with the instructions given by the Engineer or delegated assistant, on any matter related to the Contract. Whenever practicable, their instructions shall be given in writing. If the Engineer or a delegated assistant,</p> <p>(a) gives an oral instruction and</p> <p>(b) receives a written confirmation of the instruction, from (or on behalf of) the Contractor, within two working days after giving the instruction, and</p>

	<p>(c) does not reply by issuing a written rejection and/or instruction within two working days after receiving the confirmation,</p> <p>(d) then the confirmation shall constitute the written instruction of the Engineer or delegated assistant (as the case may be).</p>
New Clause-3.4	<p>Replacement of the Engineer</p> <p>Notwithstanding New-Clause 3.1/PCC, if the Employer intends to replace the Engineer, the Employer shall, not less than 21 days before the intended date of replacement, give notice to the Contractor of the name, address and relevant experience of the replacement Engineer.</p>
New Clause-3.5	<p>Determinations</p> <p>Whenever these Conditions provide that the Engineer shall proceed in accordance with this New-Clause 3.5/PCC to agree or determine any matter, the Engineer shall consult with each Party in an endeavour to reach agreement. If agreement is not achieved, the Engineer shall make a fair determination in accordance with the Contract, taking due regard of all relevant circumstances.</p> <p>The Engineer shall give notice to both Parties of each agreement or determination, with supporting particulars. Each Party shall give effect to each agreement or determination unless and until revised under Clause 4/SCC [Claims, Disputes and Arbitration].</p>
	<p>4.THE CONTRACTOR</p>
New Clause-4.1	<p>Contractor's General Obligations</p> <p>The Contractor shall design (to the extent specified in the Contract), execute and complete the Works in accordance with the Contract and with the Engineer's instructions, and shall remedy any defects in the Works.</p> <p>The Contractor shall provide the Plant and Contractor's Documents specified in the Contract, and all Contractor's Personnel, Goods, consumables and other things and services, whether of a temporary or permanent nature, required in and for this design, execution, completion and remedying of defects.</p> <p>All equipment, and material, to be incorporated in or required for the Works shall be procured from approved sources as stipulated in the Contract.</p> <ol style="list-style-type: none"> i. All plants / equipment to be deployed on the work shall carry designated authority certificate. Where not specified, it shall have third party safety certificate for the safe working of the equipment and shall be renewed after every 3 months. This certificate shall be produced to the Engineer as and when required. ii. All the construction plant shall be provided with the experienced operators having valid license issued by the competent authority. iii. Any material or equipment not meeting the approval of the Engineer shall be removed from the site immediately. iv. All Contractor's Equipment and Temporary Works provided by the Contractor shall, when brought on to the site, be deemed to be exclusively intended for execution of the Works and not be removed without the consent in writing of the Engineer. Such consent shall not be unreasonably withheld or delayed.

	<p>The Contractor shall be responsible for the adequacy, stability and safety of all Site operations and of all methods of construction. Except to the extent specified in the Contract, the Contractor (i) shall be responsible for all Contractors' Documents, Temporary Works, and such design of each item of Plant and Materials as is required for the item to be in accordance with the Contract, and (ii) shall not otherwise be responsible for the design or specification of the Permanent Works.</p> <p>The Contractor shall throughout the execution of the Works including the carrying out of any testing, commissioning or remedying of any defect:</p> <ul style="list-style-type: none"> i. provides and maintain all lights, guards, fences and warning signs and watchmen when and where necessary or required by the Engineer or by laws or by any relevant authority for the protection of the Works and for the safety and convenience of the public and all persons on or in the vicinity of the Site; and ii. Contractor is required to take note of all the necessary provisions in Employer's Safety, Health and Environment Manual (SHE Manual) and the Contractor's price shall be inclusive of all the necessary costs to meet the prescribed safety standards as specified in the Special Conditions of Contract. In the case, the Contractor fails in the above; the Employer may provide the necessary arrangements and recover the costs from the Contractor
New Clause-4.2	<p>Tools, Plants and Equipment Supplied by the Employer</p> <ul style="list-style-type: none"> i. Except for any specific item mentioned in the Special Conditions of Contract or in Employer's Requirements, the Contractor shall provide all tools, plants and Equipment for the Works. In respect of such exceptional tools, plants or Equipment committed to be provided by the Employer under terms and conditions specified in the Special Conditions of Contract, the Contractor shall take all reasonable care and shall be responsible for all damages or loss caused by him, his representatives, sub-contractors or his workmen or others while they are in his charge. ii. No tools, plant and equipment shall be supplied by the Employer. Unless specifically incorporated in special conditions, the Contractor has to arrange all tools, plant, equipment required for the work. iii. On completion of the Works, the Contractor shall hand over the unused balance of the tools, plants and Equipment supplied by the Employer to the Employer back in good order and repair, fair wear and tear expected, and shall be responsible for any failure to account for the same or any damage done thereto. iv. The decision of the Engineer as to the amount recoverable from the Contractor on this account shall be final and binding.
New Clause-4.3	<p>Employer's Materials</p> <p>Except for items mentioned in the Special Conditions of Contract, the Contractor shall provide all materials for the Works. Material if any, to be provided by Employer will be done only in a phased manner as per pre-approved program, against a Bank Guarantee for the value of the Material and at terms and conditions for issue, upkeep, usage, return and recovery of such Materials as specified in Special Conditions of Contract.</p>
New Clause-4.4	<p>Sheds, Stores, Yards</p> <p>It shall be the responsibility of the Contractor to provide at his own expense the required sheds, store houses, and yards for both Permanent and Temporary Works and provide free access to the Engineer and the Engineer's Representative who will have right of inspection including that of instructing the Contractor to remove a particular material from the stores and not to use the same on the Works.</p>

New Clause-4.5	<p>Temporary Works</p> <p>The Contractor's proposals for erection of all ancillary and temporary works shall be in conformity with the proposals submitted along with the Tender and modifications thereto as approved by Engineer.</p> <p>The Contractor shall submit drawings, supporting design calculations of Temporary works, where called for by the Engineer and other relevant details of all such works to the Engineer for approval at least one month before he desires to commence such works. Approval by the Engineer of any such proposal shall not relieve the Contractor of his responsibility for sufficiency of such works.</p> <p>All temporary works necessary for the proper execution of the Works shall be provided and maintained by the Contractor at his cost (unless otherwise provided in tender document) and subject to the consent of the Engineer shall be removed by Contractor at his own expense when they are no longer required and in such manner as the Engineer shall direct. In case the Contractor fails to remove the temporary works on completion the Engineer is authorized to get the same removed and recover the cost thereof from the Contractor.</p>
New Clause-4.6	<p>Access for Engineer</p> <p>The Contractor shall allow at all times the Engineer or the Engineer's assistant or any other person authorised by the Engineer access to the Site and to any place where work in connection with the Contract is being carried out or is intended to be carried out and to any place where materials or plant are being manufactured, fabricated and/or assembled for the Works. The Contractor shall ensure that sub contracts if any shall contain provisions entitling the Engineer or any person authorised by him to have such access.</p>
New Clause-4.7	<p>Access Road and Way Leave</p> <ol style="list-style-type: none"> I. Providing access roads/ way leaves to the site will be Contractor's responsibility. II. The Contractor shall pay the statutory vehicle license and permit fees for use of public roads. The Contractor's heavy construction or tracked equipment shall not travel on any public road or bridge, unless the Contractor has made arrangements with the authority concerned and has obtained the approval of the Engineer to such arrangements. III. The Contractor shall repair any damage to the road or bear the cost thereof due to movement of contractor's plants and equipment, vehicles etc. to the specifications and satisfaction of road authorities as well as of Engineer. IV. The Contractor shall plan transportation of construction materials to work site in accordance with traffic regulations enforced by local traffic authorities from time to time and in such a way that congestion on the roads and road accidents are avoided. The Contractor should study this aspect thoroughly before quoting for the work.
New Clause-4.8	<p>Contractor to keep Site Clear</p> <ol style="list-style-type: none"> i. During the execution of the Works, the Contractor shall keep the Site free from all unnecessary obstruction, and shall store or dispose of any Contractor's Equipment or surplus materials. The Contractor shall clear away and remove from the Site any wreckage, rubbish or Temporary Works no longer required. ii. On completion of the works, the Contractor shall clear away and remove from site all Constructional Plant, surplus material and Temporary Works. He should leave the whole of the site and Works in a clean, tidy and workman like condition to the satisfaction of the Engineer. iii. On completion of Work the Contractor shall also clear away the labour camps, hutments and other related installations and restore the land to its original condition to the satisfaction of the Engineer within 45 days of the physical completion of Work. The cost on account of

	<p>delay in return of land and reinstatement of original condition within the stipulated time as determined by Engineer will be recovered from the Contractor's dues.</p> <p>iv. All garbage shall be removed from site daily or as they accumulate. All surface and sub-soil drains shall be maintained in a clean, sound and satisfactory state of performance. No extra payment shall be made on this account.</p> <p>v. No final payment in settlement of the accounts for Works shall be made till, in addition to any other condition necessary for such final payment, site clearance and clearances of labour camps etc. shall have been effected by him. Such clearance may be made by the Engineer through any other agency at the expense of the Contractor in the event of the Contractor's failure to comply with this provision within 7 days after receiving notice to that effect from the Engineer. All expenses on such removal / clearance shall be debit able to the Contractor as loans due from the Contractor to the Employer, and the Employer shall be competent to recover the same from Contractor's on-account or final bills, or from Performance Security amount or from any other amount payable to the Contractor in any other Contract.</p>
<p>New Clause-4.9</p>	<p>Security of the Site</p> <p>I. The Contractor shall take all measures necessary to ensure security, including exercising control over all persons and vehicles which are employed or engaged on the Site or in connection with the Works or the other works comprising the Project and with the security arrangements applicable to any other site within the Project.</p> <p>II. The Contractor shall arrange the issue of passes for the admission of all persons and vehicles to the Site or to any part thereof and may refuse admission to or remove from the Site any person or vehicle failing to show an appropriate pass on demand to any duly authorized person.</p> <p>III. If required by the Engineer, the Contractor shall submit a list identifying all persons to whom passes have been issued together with two photographs of each person and all entities to which a pass has been issued in respect of any vehicle and shall satisfy the Engineer of the bonafides of any such person or entity.</p> <p>IV. The Contractor shall not, without the written permission of the Engineer or otherwise in accordance with the Contract, allow access to the Site to any person unless the presence on Site of such person is necessary in connection with the execution of the Works or with the discharge of the duties of any relevant authority.</p> <p>V. The Contractor shall be wholly responsible for security of site and Works. The Contractor shall follow relevant Safety and Security instructions issued by the concerned Authorities from time to time and shall work in close coordination with the concerned Authorities.</p>
<p>New Clause-4.10</p>	<p>Contractor's Operations on Site</p> <p>I. The Contractor shall confine his operations to the Site, and to any additional area which may be provided to the Contractor and agreed by the Engineer as working areas. The Contractor shall take all necessary precautions to keep his personnel and equipment within the Site and such additional areas, and to keep and prohibit them from encroaching on adjacent land.</p>

	<p>II. The Contractor, after obtaining any necessary consent from any relevant authority, shall submit to the Engineer proposals showing the layout of pedestrian routes, lighting, signs, and guarding any road opening or traffic diversion which may be required in connection with the execution of the Works and which the Contractor intends to construct. Any consent given by the Engineer to such proposals shall not relieve the Contractor of any obligation under the Contract or absolve the Contractor from any liability for or arising from such proposals or the implementation thereof.</p> <p>III. All lights provided by the Contractor shall be so placed or screened as not to interfere with signs, signals or lights. The Contractor shall not in any way obscure or affect signs, signals or lights, in use by any relevant authority. In the event that the Contractor does so, the Contractor shall pay all costs associated with the re-fitting, re-instating or provision of alternatives for any sign, signal or light, obscured or affected.</p> <p>IV. For the purposes of this Clause only, "Site" shall include off-Site places of manufacture or storage and the Contractor's Work Areas and shall include, areas provided to the Contractor by others.</p>
New Clause-4.11	<p>Publicity</p> <p>The Contractor shall not publish or otherwise circulate alone or in conjunction with any other person, any articles, photographs or other materials relating to the Contract, the Site, the Works, the Project or any part thereof, nor impart to the press, or any radio or television network any information relating thereto, nor allow any representative of the media access to the Site, Contractor's Works Areas, or off-Site place of manufacture, or storage except with the permission, in writing, of the Employer. The Contractor shall ensure that his sub-contractors of any tier shall be bound by a like obligation and shall, if so required by the Employer, enforce the same at his own expense. The provisions of this Sub-Clause shall not exempt the Contractor from complying with any statutory provision in regard to the taking and publication of photographs.</p>
New Clause-4.12	<p>Disclosure of Relationship</p> <p>If the Contractor or any partner of the Contractor or Director of the Contractor's company is closely related to any of the Officers of the Employer or the Engineer, or alternatively, if any close relative of an officer of the Employer or the Engineer has financial interest / stake in the Contractor's firm, the same shall be disclosed by the Contractor at the time of filing his tender. Any failure to disclose the interest involved, shall entitle the Employer to rescind the Contract, without payment of any compensation to the Contractor. The Contractor shall note that he is prohibited from developing such interest during the Contract period.</p>
New Clause-4.13	<p>Use Of Explosives</p> <p>Explosives if required on the Work shall be used by Contractor only with prior Approval of the Engineer and in the manner and to the extent permitted by him. The explosives shall be handled, stored in a special magazine to be provided at the cost of the Contractor and used under the strict supervision of persons licensed for this purpose under the requisite statutory rules and regulations. The Contractor shall take all precautions in transporting and using the explosives and avoid damage to nearby structures and utilities. The Contractor shall be responsible for taking all the precautions in the usage of the explosives at Contractor's cost, sole risk and responsibility. The Contractor shall hold the Employer harmless and indemnify for the above.</p>
New Clause-4.14	<p>In pursuance with this policy, the Employer</p> <p>a. Will reject the Tender for the Work or rescind the Contract, if the Employer determines that the Tenderer/Contractor has engaged in corrupt or fraudulent practices.</p>

	<p>b. Will declare a Tenderer/Contractor ineligible, either indefinitely or for a minimum period of 2 years from the date of identification of such prohibited conduct, to be awarded a Contract/s if the Employer at any time determines that the Contractor has engaged in corrupt or fraudulent practices in competing for, or in executing the Contract.</p>
New Clause-4.15	<p>Compensation to Contractor on rescission of Contract under this clause</p> <p>In the event of rescission of Contract, the Contractor shall not be entitled to any compensation whatsoever, except for the work done up to the date of rescission.</p>
New Clause-4.16	<p>Quality Assurance</p> <p>Unless otherwise stated in Special Conditions of Contract and/or Employer's Requirement, the Contractor shall institute a quality assurance system to demonstrate compliance with the requirements of the Contract. Such system shall be in accordance with the details stated in the Contract. Compliance with the quality assurance system shall not relieve the Contractor of his duties, obligations or responsibilities.</p> <p>Details of all procedure and compliance documents shall be submitted to the Engineer for his consent before each execution stage is commenced</p>
New Clause-4.17	<p>Work by Persons Other than Contactor</p> <ol style="list-style-type: none"> I. If the Contractor shall fail to carry out any work required under the Contract or refuse to comply with any instruction or order given by the Engineer in accordance with the Contract within a reasonable time, the Engineer may give the Contractor 14 days' notice in writing to carry out such work or comply with such instruction. II. If the Contractor fails to comply with such notice, the Employer shall be entitled to carry out such work or instruction by his own workmen or by other contractors in whatever manner the Engineer decides, be it single Tender or limited Tender or open Tender or on entrustment basis without any right of appeal by the contractor. III. However, in case of emergencies/urgencies/affecting safety the period of 14 days' notice shall be 24hours notice in writing. The Classification of work as emergencies/urgencies/affecting safety is the prerogative of Engineer and his decision is final and binding on the contractor. Without prejudice to any other right or remedy, all additional expenditure properly incurred by the Employer in having such work or instruction carried out shall be recoverable by the Employer from the Contractor. IV. If by reason of any accident or failure or other event occurring to, in, or in connection with the Works any remedial or other work shall, in the opinion of the Engineer, be urgently necessary and the Contractor is unable or unwilling at once to do such remedial or other work, the Engineer may authorize the carrying out of such remedial or other work by a person other than the Contractor. V. If the remedial or other work so authorized by the Engineer is work, which, in the Engineer's opinion, the Contractor was liable to do under the Contract; all expenses properly incurred in carrying out the same shall be recoverable by the Employer from the Contractor. Provided that the Engineer shall, as soon after the occurrence of any such emergency as may be reasonably practicable, notify the Contractor thereof in writing.
New Clause-4.18	<p>Confidentiality of Information</p> <ol style="list-style-type: none"> I. The Contractor shall not use or divulge, except for the purpose of the Contract or with the written permission of the Employer, any information relating to the Works or the Project provided in the Contract or otherwise provided by the Employer, or the Engineer. The Contractor shall ensure that his sub-contractors of any tier shall be bound by a like confidentiality undertaking.

	<p>II. The Employer, Engineer and any third party to whom an assignment has been made in accordance with New-clause 2.3/PCC may use any information provided by the Contractor in accordance with the Contract. The Employer shall use reasonable endeavours to ensure that the Engineer and any third party referred to in aforesaid New-clause 2.3/PCC shall not; divulge such information except for any purpose connected with the Contract.</p> <p>On completion of the works, the contractor shall arrange to furnish to the Employer two (2) bound sets of all "As Built" drawings for every component of the Works at his own cost, all such copies being on Polyester film of quality to be approved by the Engineer or his Representative. The Taking – over Certificate of the Works, as per the provisions of Clause 46.1/PCC herein, shall not be issued by the Engineer in the event of the Contractor's failure to furnish the aforesaid "As Built" drawings for the entire works.</p> <p>If the Contract specifies that the Contractor shall design any part of the Permanent Works, then unless otherwise stated in the Special Conditions of Contract:</p> <ul style="list-style-type: none"> (a) the Contractor shall submit to the Engineer the Contractor's Documents for this part in accordance with the procedures specified in the Contract; (b) these Contractor's Documents shall be in accordance with the Specification and Drawings, shall be written in the language for communications defined in Sub-Clause 3/CC [Law and Language], and shall include additional information required by the Engineer to add to the Drawings for co-ordination of each Party's designs; (c) the Contractor shall be responsible for this part and it shall, when the Works are completed, be fit for such purposes for which the part is intended as are specified in the Contract; and (d) prior to the commencement of the Tests on Completion, the Contractor shall submit to the Engineer the "as-built" documents and operation and maintenance manuals in accordance with the Specification and in sufficient detail for the Employer to operate, maintain, dismantle, reassemble, adjust and repair this part of the Works. Such part shall not be considered to be completed for the purposes of taking-over under Sub-Clause 46.1/PCC [Taking Over of the Works and Sections] until these documents and manuals have been submitted to the Engineer.
<p>New Clause-4.19</p>	<p>Performance Security:</p> <p>The Contractor shall obtain (at his cost) a Performance Security and an additional Performance Security, if any in terms of ITT 25.5, for proper performance of the contract, for the amount, currencies and validity period for Performance Security stated in the Contract Data. If an amount is not stated in the Contract Data, this Sub-Clause shall not apply. The Contractor shall deliver the Performance Security and additional Performance Security, if any, to the Employer within 20 days after receiving the Letter of Acceptance, and shall send a copy to the Engineer. The Performance Security/additional Performance Security shall be issued by an entity and from within a country (or other jurisdiction) approved by the Employer and shall be in the form as given in Section 10 (Formats) or in another form specifically approved by the Employer. The procedure for obtaining Performance Guarantee is outlined below: The successful bidder shall have to</p>

submit a Performance Guarantee (PG) within 20 (Twenty) days from the date of issue of Letter of Acceptance (LOA). Extension of time for submission of PG beyond 20 (Twenty) days and upto 60 days from the date of issue of LOA may be given by the Authority who is competent to sign the contract agreement. However, a penal interest of 12% per annum shall be charged for the delay beyond 20 (Twenty) days, i.e. from 21st day after the date of issue of LOA. Further, if the 60th day happens to be a declared holiday in the concerned office of the Railway, submission of PG can be accepted on the next working day. In all other cases, if the Contractor fails to submit the requisite PG even after 60 days from the date of issue of LOA, the contract is liable to be terminated. In case contract is terminated railway shall be entitled to forfeit Earnest Money Deposit and other dues payable against that contract. In case a tenderer has not submitted Earnest Money Deposit on the strength of their registration as a Startup recognized by Department for promotion of industry and internal trade (DPIIT) under Ministry of Commerce and Industry, DPIIT shall be informed to this effect. The failed Contractor shall be debarred from participating in re-tender for that work.

The Performance Security/additional Performance Security shall be, at the Contractor's option, in any of the following forms:

- (i) An unconditional Bank Guarantee in the prescribed format
- (ii) A Pay Order / Demand Draft drawn on a Scheduled / Nationalized Bank in India in favour of "Rail Infrastructure Development Company (Karnataka) Ltd" payable at Bangalore.
- (iii) FDR in favour of "Rail Infrastructure Development Company (Karnataka) Ltd." (free from any encumbrance).
- (iv) A online bank transfer to K-RIDE account.

The Bank Guarantee shall be from a bank having minimum net-worth of over INR 500 million from the specified banks as under:

- (i) a Schedule Bank in India, or
- (ii) a Foreign Bank having their operations in India, or
- (iii) a Foreign Bank which does not have operations in India is required to provide a counter-guarantee by State Bank of India,

The Scheduled Bank is suing the Bank Guarantee must be on "Structured Financial Messaging System (SFMS)" platform. A separate advice of the BG shall be invariable be sent by the issuing bank to the Employer's Bank through SFMS and only after this the BG shall become operative and acceptable to the Employer.

The Issuing Bank shall send the SFMS to:

Beneficiary: Rail Infrastructure Development Company (Karnataka) Ltd. (K-RIDE)

Bank Name: Canara Bank

Branch: Prime Corporate Branch

Account No. 0430201012110

IFSC Code: CNRB0002636.

In case the contractor is a JV;" the Performance Security/additional Performance Security, if any in terms of ITT 25.5, shall be submitted by each JV Partner separately on behalf of the JV in favour of K-RIDE in proportion of their respective percentage share specified in the JV Agreement. The additional Performance Security shall be submitted by the partner(s) responsible for execution of schedule(s) (as per JV agreement) against which additional Performance Security is required to be submitted in terms of ITT 25.5.

However, Submission of Performance Guarantee Security by individual partners on behalf of the JV shall in no way dilute their Joint & Several responsibility. The Employer shall be entitled to recover the amount of Bank Guarantees individually and / or from all the Partners jointly at its discretion."

The Contractor shall ensure that the Performance Security/additional Performance Security is valid and enforceable until the Contractor has executed and completed the Works and remedied defects, if any. If the contractor does not complete the work for any reasons whatsoever, the terms of the Performance Security/ additional Performance Security specify its expiry date, and the Contractor has not become entitled to receive the Performance Certificate by the date 28 days prior to the expiry date, the Contractor shall be bound to extend the validity of the Performance Security/additional Performance Security until the Works have been completed and any defects have been remedied.

Failure of the successful Tenderer to furnish the required Performance Security shall be a ground for the annulment of the award of Contract and execution of the Tender Securing Declaration.

Release of performance security:

- i. The whole or such portion of the Performance Security amount shall be liable to be forfeited by the Employer at the discretion of the Employer, in the event of any breach of Contract on the part of the Contractor.
- ii. After completion of the entire Work, the Performance Security shall be released to the Contractor, on issue of last Taking Over Certificate if more than one Certificate exist, by the Engineer, the release of Performance Security shall not relieve the Contractor from his obligations and liabilities, to make good that may be detected during the Defects Liability Period.

The Guarantees shall be unconditional and irrevocable. The Employer shall return the Performance Security to the Contractor within 21 days after receiving a copy of the Performance Certificate or passing of the Final Payment Certificate whichever is later. However, on completion of specified section(s) and successful passage of defect liability period for such section(s) along with execution of any leftover works at the time of completion of such section(s), the contractor shall be entitled for release of 90% of the proportionate Performance Security calculated as specified in Contract Data subject to the condition that Engineer certifies that no recoveries are pending in the contract. In case Engineer points out amount to be recovered then the contractor

shall be entitled for release of 90% of the proportionate Performance Security calculated as specified in Contract Data minus the amount to be recovered.

The Employer shall return additional Performance Security submitted in terms of ITT 25.5 as per the following;

(a) If the Contractor submits an application stating that all the works against the particular schedule(s)/bill(s) for which additional Performance Security was submitted in terms of ITT 25.5 have been completed in all respect, then the Employer, on being satisfied with the claim of the Contractor, shall return the full additional Performance Security against the particular schedule(s). Decision of the Employer regarding completion of works against a particular schedule/bill shall be final and binding on the Contractor.

(b) If the Contractor submits an application stating that majority of the works (physical progress being not less than 90%) against the particular schedule(s)/bill(s) for which additional Performance Security was submitted in terms of ITT 25.5 have been completed and execution of balance works is held up for reasons not attributable to the Contractor, then the Employer, on being satisfied with the claim of the Contractor, shall return 75% of the amount of additional Performance Security against the particular schedule(s). The balance amount of additional Performance Security shall however be returned only after completion of the works against the particular schedule(s)/bill(s) for which additional Performance Security was submitted in terms of ITT 25.5, in all respects to the satisfaction of the Employer. Decision of the Employer regarding completion of works against a particular schedule/bill shall be final and binding on the Contractor.

Without limitation to the provisions of the rest of this Sub Clause, whenever the Engineer determines an addition or a reduction to the Contract Price as a result of a change in cost and/or legislation or as a result of a Variation amounting to more than 25 percent of the portion of the Contract Price payable in a specific currency, the Contractor shall at the Engineer's request promptly submit Performance Guarantee @ 10% of the increased amount over the original contract price in a specific currency. On the other hand if the value of contract price decreases by more than 25% of the original contract price payable in a specific currency, Performance Guarantee @ 10% of the decrease in contract price from the original contract price in a specific currency shall be returned to the contractor, on his request.

Wherever the contract is terminated under Clause 49.7/PCC, the Performance Guarantee shall be encashed by the Employer:

- i) in full including additional Performance Guarantee amount, if any, taken in terms of clause 25.5 and 29 of ITT and not due for release on the date of issue of termination letter in terms of this clause, in case of termination of the contract as a whole; or
- ii) at the discretion of the Employer it may be encashed in part/parts proportionate to the Contract price of the bill/schedule to which the terminated part of work belongs
i.e
 $P = (A \times B) \div C$ where
P=Proportionate Bank Guarantee Amount.
A=Contract price of the particular bill/schedule to which the terminated part of work belongs.

	<p>B=Performance Guarantee amount in terms of CC New-clause 4.19/PCC C=Total Contract price.</p> <p>Plus additional performance Guarantee amount, if any, taken in terms of sub clause 25.5 and 29 of ITT and not due for release on the date of issue of termination letter in terms of this clause against this particular bill/schedule to which the terminated part of the work belongs, in case of termination in part/parts.</p> <p>The balance work should be got done separately, and independently by K-RIDE without risk and cost of the original contractor. The original contractor shall be debarred from participating in the tender for executing the balance work. If the failed contractor is a JV or a partnership firm, then every member/partner of such a firm would be debarred from participating in the tender for the balance work either in his/her individual capacity or as a partner of any other JV/partnership firm.</p> <p>In case the Contractor fails to perform the Contract or any JV partner fails to perform its obligations under the JV agreement, which is a part of this agreement, the Employer may issue notice of such default to the said JV partner or the JV (depending upon reasons of default) and declare the said JV partner or the JV as Poor Performer. The issue of such notice shall automatically debar the JV partner or JV, as the case may be, from participating in any K-RIDE tender from the date of issue of notice of default. The relevant performance security including additional performance security, if any, in terms of sub clauses 25.5 and 29 of ITT submitted by the Contractor or submitted on behalf of JV partner to the extent not due for release at the time of contemplation of such action shall be encashed and forfeited either fully or in proportion of the percentage share of that partner in the JV agreement, as the case may be.</p>
<p>New Clause-4.20</p>	<p>Security Deposit: The Security Deposit shall be 5% of the contract value. Security Deposit may be deposited by the Contractor before release of first on account bill in cash or Term Deposit Receipt issued from Scheduled Bank, or may be recovered at the rate defined in this section PCC, the bill amount till the full Security Deposit is recovered. Provided also that in case of defaulting Contractor, the Employer may retain any amount due for payment to the Contractor on the pending "on account bills" so that the amounts so retained (including amount guaranteed through Performance Security) may not exceed 10% of the total value of the contract. The security deposit may be recovered at the rate 6% of bill amount till the security deposit is recovered.</p> <p>Further, in case of contracts having value equal to or more than ₹ 50 crore (Rs Fifty crore) the Security Deposit may be deposited as Bank Guarantee Bond also, issued by a scheduled bank after execution of contract documents, but before payment of 1st on account bill. Provided further that the validity of Bank Guarantee Bond shall be extended from time to time, depending upon extension of contract granted in terms Clause No 26 of PCC.</p> <p>Further, in case Security Deposit has been submitted as Term Deposit Receipt/Bank Guarantee Bond in full amount, the Bid security by Contractor with his tender will be returned by K-RIDE.</p> <p>Note: After the work is physically completed as certified by competent authority, Security Deposit recovered from the running bills of a Contractor can be returned to him, if he so desires, in lieu of Term Deposit Receipt/irrevocable Bank Guarantee for equivalent amount from Scheduled Bank, to be submitted by him.</p> <p>4.2.b(i) Refund of Security Deposit: Security Deposit mentioned in clause above shall be returned to the Contractor along with or after, the following:</p>

	<p>(a) Final Payment of the Contract and</p> <p>(b) Execution of Final Supplementary Agreement or Certification by Engineer that K-RIDE has No Claim on Contractor and</p> <p>(a) Maintenance Certificate issued, on expiry of the maintenance period.</p> <p>4.2.b(ii) Forfeiture of Security Deposit: Whenever the contract is rescinded as a whole under clause 49 of CC/PCC, the Security Deposit already with K-RIDE under the contract shall be forfeited. However, in case the contract is rescinded in part or parts under clause 49 of CC/PCC, the Security Deposit shall not be forfeited.</p> <p>4.2.(c) No interest shall be payable upon the Bid Security and Security Deposit or amounts payable to the Contractor under the Contract, but Government Securities deposited in terms of New-Clause 4.19/PCC of this clause will be payable with interest accrued thereon.</p>
<p>New Clause -4.21</p>	<p>Contractor Representative:</p> <p>The Contractor shall depute his Representative to attend all the review meetings notified by the Engineer.</p> <p>Facilities for and Co-ordination with Others</p> <p>The Contractor shall not impede and shall afford all necessary facilities, access and/or services to the Employer, Engineer, Designated Contractors, utility undertakings, other relevant authorities and other contractors (whether employed by the Employer or not) who are carrying out on, or in the vicinity of, the Site, works not included in the Contract but forming part of the Project:</p> <p>A. The Contractor shall take all reasonable steps to ensure that the Works are co-ordinated and integrated with the Design, manufacture, installation execution and testing of such other works and shall in particular (but without limitation):</p> <p>(i) comply with any direction which the Engineer may give for the integration of the Design with the design of any other part of the Project;</p> <p>(ii) consult, liaise and co-operate with those responsible for carrying out such other works, including where necessary, in the preparation of the respective designs, the preparation of co-ordinated programmes, method statements, co-ordination drawings and specifications together with arrangements of service priorities and zoning;</p> <p>B. The Contractor shall undertake Design co-ordination with other contractors who are carrying out works forming part of the Project as described in the Employer's Requirements. At the end of each such co-ordination period, the Contractor and the other contractor with whose works the interface period refers shall jointly state in writing that their design co-ordination activities are complete and that their respective designs are integrated and can be finalised without interference with each other's designs or the designs with which their designs have already been integrated.</p> <p>A copy of this joint written statement shall be provided to the Engineer within 7 days of the end of the said design co-ordination period. Unless and until copies of all relevant and necessary design co-ordination statements have been submitted to the Engineer, the Engineer shall be entitled to suspend any review or further review of the Contractor's or the other contractor's design submissions. Such suspension shall not be grounds for the</p>

	<p>Contractor to claim nor shall be entitled to receive an extension of time or additional payments.</p> <p>C. The Contractor shall share within the Site, staging, storage and unloading areas for the use of Designated Contractors, if any, who are undertaking civil work, fare collection system, supply, testing and commissioning of Rolling Stock, escalators, lifts, signalling and telecommunications and traction power installation works, etc. Separate locations shall be provided for each such contractor. The exact size and location of these staging, storage and unloading areas, and the commencement date shall be co-ordinated and agreed during the design interface period with each Designated Contractor.</p> <p>D. Any other contract which depends for its execution on the Contract or upon which the Contract is dependent for its own execution shall be identified by the Engineer as a "Designated Contract". The Contractor shall provide attendance on Designated Contractors in accordance with the Employer's Requirements and as instructed by the Engineer. The identity of the contractor for a Designated Contract may not be known before the execution of the Contract but this shall not be a ground for the Contractor to object to the subsequent appointment of a Designated Contractor</p> <p>E. The Contractor shall in accordance with the requirements of the Engineer co-ordinate his own Works with that of Designated Contractors through Co-ordinated Installation Programme (CIP) stated in the Employer's Requirements, or as the Engineer may require, and shall afford the Designated Contractors all reasonable opportunities for carrying out their works.</p> <p>F. The Contractor shall afford all reasonable opportunities, for carrying out their work, to other contractors employed by the Employer and their workmen respectively and the workmen of the Employer who may be engaged on or near the Site of any work, ancillary to the Works, but, not included in the Contract and shall not cause them inconvenience.</p> <p>G. If the Contractor shall suffer delay by reason of failure by any Designated Contractor to meet the specified installation interfacing and co-ordination, completion dates, which delay shall be caused otherwise than by fault of the Contractor, or, if compliance with sub-clause (f) herein shall involve the Contractor in delay beyond that which could be reasonably foreseen by an experienced contractor at the time of tender, then the Engineer shall take such delay into account in determining any extension of time to which the Contractor is entitled under the Contract.</p> <p>H. It shall be the responsibility of the Contractor to ensure that the full extent of the Works under the Contract and the works to be carried out by Designated Contractors within the Works or, in, on, under, through and over the Site are co-ordinated and integrated in their design, manufacture, installation and construction. Such responsibility shall neither be mitigated nor in any other way affected by virtue of similar responsibilities being placed on other contractors.</p> <p>The Contractor shall be deemed to have made adequate allowance in the Contract Price and in the Works Programme in respect of these obligations.</p> <p>If any act or omission of the Contractor whether directly or indirectly results in the delay in the execution of the works of a Designated Contractor, the Contractor, in addition to his liability in respect of liquidated damages if they become due, shall pay to the Employer, or the Engineer may deduct from Interim Payment Certificates such amount as the Engineer shall have certified in respect of additional payments or costs to the Designated Contractor in respect of such delay.</p>
New Clause-4.22	DELETED

New Clause-4.23	DELETED
New Clause-4.24	<p>Co-operation</p> <p>The Contractor shall, as specified in the Contract or as instructed by the Engineer, allow appropriate opportunities for carrying out work to:</p> <ul style="list-style-type: none"> (a) the Employer's Personnel, (b) any other contractors employed by the Employer, and (c) the personnel of any legally constituted public authorities, <p>who may be employed in the execution on or near the Site of any work not included in the Contract.</p> <p>Any such instruction shall constitute a Variation if and to the extent that it causes the Contractor to incur Unforeseeable Cost. Services for these personnel and other contractors may include the use of Contractor's Equipment, Temporary Works or access arrangements which are the responsibility of the Contractor.</p> <p>If, under the Contract, the Employer is required to give to the Contractor possession of any foundation, structure, plant or means of access in accordance with Contractor's Documents, the Contractor shall submit such documents to the Engineer in the time and manner stated in the Specification.</p>
New Clause-4.25	<p>Setting Out</p> <p>The Contractor shall set out the Works in relation to original points, lines and levels of reference specified in the Contract or notified by the Engineer. The Contractor shall be responsible for the correct positioning of all parts of the Works, and shall rectify any error in the positions, levels, dimensions or alignment of the works, notifying the Engineer within 28 days of the date of commencement</p> <p>In the event of such discrepancy arising during the course of the work, for which Employer's documents are handed over after the date of commencement, the contractor shall seek clarifications within 14 days of receipt of such documents</p> <p>The Employer shall be responsible for any errors in these specified or notified items of reference, but the Contractor shall use reasonable efforts to verify their accuracy before they are used.</p> <p>Contractor shall promptly notify the Employer and the Engineer of any error, omission, fault, or any other defect in the design, drawing or specifications for the works, which he discovers when reviewing the Contract Documents, and in the process of execution of the Works. The contractor shall be responsible to ensure correlation in various drawings and bill of quantities, before commencement and execution of work. In case of any discrepancy the contractor shall bring it to notice of the Engineer for clarification within 28 days of the issue of Letter of Acceptance. In the event of such discrepancy arising during the course of the work, for which drawings are given after the date of issue of Letter of Acceptance, the contractor shall seek clarifications within 14 days of receipt of such drawings.</p> <p>Notwithstanding with any other provision, the Contractor shall have to pay penalty for damage to Railway cable in terms of clause C 15 of the JPO as given in para 1.2 of Chapter 1. (Safety and Security) of Section 8 and shall also indemnify the Employer against any losses, damages to property or life in terms of para 1.11 and 1.12 of the chapter 1. (Safety and Security) of Section 8.</p>
New Clause-4.26	Safety Procedures-

The Contractor shall follow the provisions laid down in Chapter 1. (Safety and Security) of Section 8 and shall:

- (a) comply with all applicable safety regulations,
- (b) take care for the safety of all persons entitled to be on the Site,
- (c) use reasonable efforts to keep the Site and Works clear of unnecessary obstruction so as to avoid danger to these persons,
- (d) provide fencing, lighting, guarding and watching of the Works until completion and taking over under Clause 46/PCC [Employer's Taking Over], and
- (e) provide any Temporary Works (including roadways, footways, guards and fences) which may be necessary, because of the execution of the Works, for the use and protection of the public and of owners and occupiers of adjacent land.

Additional Safety Precautions

- (1) The Contractor shall comply with all the precautions as required for the safety of the workmen by the I.L.O Convention No.62 as far as they are applicable to the Contract. The Contractor shall provide all necessary safety appliances; such as safety goggles, helmets, masks, etc to the workmen and the staff.
- (2) Suitable scaffolds shall be provided for workmen for all work that cannot safely be done from the ground, or from solid construction except for such short period work as can be done safely from ladders. When a ladder is used, an extra labourer shall be engaged for holding the ladder and if the ladder is used for carrying materials as well, suitable foot-holds and hand-holds shall be provided on the ladder, which shall be given an inclination not steeper than 1/4 to 1 (1/4 horizontal in 1 vertical).
- (3) **DELETED**
- (4) **DELETED**
- (5) Every opening in the floor of a structure or in a working platform shall be provided with suitable means to prevent fall of persons or materials by providing suitable fencing or railing with a minimum height of one metre.
- (6) Safe means of access and egress shall be provided to all working platforms and other working places. Every ladder shall be securely fixed. No portable single ladder shall be over 9 metres in length. The width between side rails in a rung ladder shall in no case be less than 30 cm for ladders up to and including 3 metres in length. For longer ladders the width shall be increased at least 6 mm for each additional 30 cm of length. Spacing of steps shall be uniform and shall not exceed 30 cm.
- (7) Adequate precautions shall be taken to prevent danger from electrical equipment. Adequate safety measures shall be taken when any work is undertaken near any live highly charged electric wire. Necessary shutdown may be arranged, where and whenever essential. All rules in force in this connection shall be fully complied with. The Contractor shall ensure all precautions to prevent any accidents due to electrocution or otherwise.
- (8) No materials on any of the sites shall be so stacked or placed as to cause danger or inconvenience to any person or the public. The Contractor shall provide all necessary fencing and lights to protect the public from accidents and shall be bound to bear the

expenses of defending every suit, action or other proceedings at law that may be brought by any person for injury sustained owing to neglect of the above precautions and to pay any damages and costs which may be awarded in any such suit, action or proceedings to any such person or which may with the consent of the Contractor be paid to compromise any claim by any such person.

- (9) **DELETED**
- (10) Demolition : Before any demolition work is commenced and also during the process of the work :
- (a) All roads and open areas adjacent to the work site shall either be closed or suitably protected.
 - (b) No electric cable or apparatus, which is liable to be a source of danger other than a cable or apparatus used by operators, shall remain electrically charged:
 - (c) All practical steps shall be taken to prevent danger to persons employed by the Employer, from risk of fire or explosion, or flooding. No floor, roof or other part of a building shall be so overloaded with debris or materials as to render it unsafe.
- (11) All necessary personal safety equipment as considered adequate by the Engineer shall be available for use of persons employed on the site and maintained in a condition suitable for immediate use; and the Contractor shall take adequate steps to ensure proper use of such equipment by those concerned.
- (a) Workers employed on mixing asphaltic materials, cement, lime mortars, concrete etc. shall be provided with protective footwear and protective goggles.
 - (b) Those engaged in handling any material, which is injurious to the eyes, shall be provided with protective goggles.
 - (c) Those engaged in welding works shall be provided with welder's protective eye-shield.
 - (d) Stone breakers shall be provided with protective goggles and protective clothing and seated at sufficiently safe intervals.
 - (e) **DELETED**
- (12) The Contractor shall not employ men below the age of 18 years and women, on the work of painting with products containing lead in any form. Whenever men above the age of 18 years are employed on the work of lead painting, the following precautions shall be taken
- (a) No paint containing lead or lead products shall be used except in the form of paste or readymade paint.
 - (b) Suitable face masks shall be supplied for use by workers when paint is applied in the form of spray or a surface having lead paint dry rubbed and scrapped.

	<p>(c) Overalls shall be supplied by the Contractor to workmen and adequate facilities shall be provided to enable workers to wash during and at the close of any day's work.</p> <p>13) When work is performed near any place where there is risk of drowning all necessary equipment shall be provided and kept ready for use and all necessary steps taken for prompt first aid treatment of all injuries likely to be sustained during the course of the work.</p> <p>(14) Use of hoisting machines and tackle including their attachments, anchorage and supports shall conform to the following:</p> <p>(i) These shall be of good mechanical construction, sound material and adequate strength and free from patent defects and shall be kept in good working order, be regularly inspected and properly maintained.</p> <p>(ii) Every rope used in hoisting or lowering materials or as a means of suspension shall be of durable quality and adequate strength, and free from defects</p> <p>a) Every crane driver or hoisting appliance operator shall be properly qualified and no person under the age of 21 shall be in charge of any hoisting machine including scaffold equipment. Only trained men over the age of 21 shall be permitted to give signals to such plant and appliance operators.</p> <p>For every hoisting machine and every chain hook, shackle, swivel and pulley block used in hoisting, lowering or as means of suspension, safe working load shall be ascertained by adequate means. Every hoisting machine and all gear referred to above shall be plainly marked with safe working load. In case of a hoisting machine or a variable safe working load, each safe working load and conditions under which it is applicable shall be clearly indicated. No part of any machine or any gear referred to in the paragraph above shall be loaded beyond safe working load except for the purpose of testing.</p> <p>b) In case of the Employer's machine, safe working load shall be notified by the Engineer or his Representative. As regards Contractor's machines, the Contractor shall notify safe working load of each machine to the Engineer or his Representative, whenever he brings it to the site of work and get it verified by him.</p> <p>(15) Motors, gearing, transmission, electric wiring and other dangerous parts of hoisting appliances shall be provided with efficient safeguards; hoisting appliances shall be provided with such means as will reduce the risk of accident during descent of load to the minimum. Adequate precautions shall be taken to reduce to the minimum risk of any part of a suspended load becoming accidentally displaced. When workers are employed on electrical installations, which are already energised, insulating mats, working apparel such as gloves, sleeves and boots, as may be necessary, shall be provided. Workers shall not wear any rings, watches and carry keys or other materials which are good conductor of electricity.</p> <p>(16) All scaffolds, ladders and other safety devices mentioned or described herein shall be maintained in a safe condition and no scaffold, ladder or equipment shall be altered or</p>
--	---

	<p>removed while it is in use. Adequate washing facilities shall be provided at or near places of work.</p> <p>(17) These safety provisions shall be brought to the notice of all concerned by displaying on a notice board at a prominent place at the work location. Persons responsible for ensuring compliance with the Safety Code shall be named therein by the Contractor.</p> <p>(18) To ensure effective enforcement of the rules and regulations relating to safety precautions, arrangements made by the contractor shall be open to inspection by the Engineer or his Representative.</p> <p>(19) Notwithstanding anything contained in conditions (1) to (17) above, the Contractor shall at its own costs, remain liable to comply with the provisions of all acts, rules, regulations, and bylaws for the time being in force in India and applicable in this matter.</p> <p>(20) For work carried out in the vicinity of any wharf or quay, the Contractor shall abide by all the provisions of the Dock Workers (Safety, Health and Welfare) Scheme, 1961.</p> <p>(21) The Contractor shall at his own expense provide protective safety Equipment like gloves and footwear for all labour engaged on concrete mixing work and all other types of working involving the use of tar, cement, etc. to the satisfaction of the Engineer or his Representative, and on his failure to do so, the employer shall be entitled to provide the same and recover the cost from the Contractor.</p> <p>The Contractor shall be responsible for observance, by the sub-contractors, of the foregoing provisions.</p> <p>(23) All construction labour at all-time shall use personal protective equipment like, safety shoes, helmets and reflective jackets in all activities at site. This shall be ensured without fail on each work site. Failing to comply with this, provision shall attract penalty of Rs. 500/- per occasion per staff.</p> <p>Notwithstanding with any other provision, the Contractor shall have to pay penalty for damage to Railway cable in terms of clause C 15 of the JPO as given in para 1.2 of Chapter 1. (Safety and Security) of Section 8 and shall also indemnify the Employer against any losses, damages to property or life in terms of para 1.11 and 1.12 of the chapter 1. (Safety and Security) of Section 8).</p>
New Clause-4.27	<p>Quality Assurance</p> <p>The Contractor shall institute a quality assurance system to demonstrate compliance with the requirements of the Contract. The system shall be in accordance with the details stated in the Contract. The Engineer shall be entitled to audit any aspect of the system.</p> <p>Details of all procedures and compliance documents shall be submitted to the Engineer for information before each design and execution stage is commenced. When any document of a technical nature is issued to the Engineer, evidence of the prior approval by the Contractor himself shall be apparent on the document itself.</p> <p>Compliance with the quality assurance system shall not relieve the Contractor of any of his duties, obligations or responsibilities under the Contract.</p> <p>Quality Control</p> <p>Within 28 days of the issue of the Letter of acceptance, the Contractor shall submit to the Engineer, for his consent, his proposed Site Quality Plan based on the Outline Quality Plan and the Employer's Requirements. The quality manual should address the quality system</p>

	<p>as required by ISO 9001-1991. Any supplement to the Site Quality Plan shall be submitted at least 14 days before commencement of the relevant work.</p> <p>Upon the Engineer notifying his consent to the Site Quality Plan, or any supplement thereto, the Contractor shall, adhere to the principles and procedures contained in such document, except where the Engineer gives his consent to any amended or varied version thereof. The Contractor shall cause any sub-contractors to adhere to this Plan.</p> <p>The Contractor shall appoint a suitably qualified and experienced person, not otherwise engaged in the performance of the Contract, to act as manager of the quality assurance system and shall provide such other personnel and resources as required to ensure effective operation of the quality assurance system. The said manager shall carry out audits of the application of the quality assurance system, and ensure effective quality control and delivery of quality assurance.</p> <p>The Contractor shall provide all necessary access, assistance and facilities to enable the Engineer to carry out surveillance visits both on and off the Site to verify that the quality assurance system is being properly and fully implemented. No extra payment shall be made in this regard and the cost of the Work under this element shall be deemed to be included in the Contract Price.</p>
<p>New Clause-4.28</p>	<p>Site Data</p> <p>The Employer shall have made available to the Contractor for his information, prior to the Base Date, all relevant data in the Employer's possession on sub-surface and hydrological conditions at the Site, including environmental aspects. The Employer shall similarly make available to the Contractor all such data which come into the Employer's possession after the Base Date. The Contractor shall be responsible for interpreting all such data.</p> <p>To the extent which was practicable (taking account of cost and time), the Contractor shall be deemed to have obtained all necessary information as to risks, contingencies and other circumstances which may influence or affect the Bid or Works. To the same extent, the Contractor shall be deemed to have inspected and examined the Site, its surroundings, the above data and other available information, and to have been satisfied before submitting the Bid as to all relevant matters, including (without limitation):</p> <ul style="list-style-type: none"> (a) the form and nature of the Site, including sub-surface conditions, (b) the hydrological and climatic conditions, (c) the extent and nature of the work and Goods necessary for the execution and completion of the Works and the remedying of any defects, (d) the Laws, procedures and labour practices of the Country, and (e) the Contractor's requirements for access, accommodation, facilities, personnel, power, transport, water and other services. (f) Data made available by the Employer in accordance with the preceding paragraph shall be deemed to include data listed elsewhere in the contract as open for inspection at the address stipulated in the Contract.
<p>New Clause-4.29</p>	<p>Sufficiency of the Accepted Contract Amount</p> <p>The Contractor shall be deemed to:</p> <ul style="list-style-type: none"> a) have satisfied himself as to the correctness and sufficiency of the Accepted Contract Amount, and

	<p>b) have based the Accepted Contract Amount on the data, interpretations, necessary information, inspections, examinations and satisfaction as to all relevant matters referred to in New-Clause 4.28/PCC [Site Data].</p> <p>Unless otherwise stated in the Contract, the Accepted Contract Amount covers all the Contractor's obligations under the Contract (including those under Provisional Sums, if any) and all things necessary for the proper execution and completion of the Works and the remedying of any defects.</p>
New Clause-4.30	<p>Unforeseeable Physical Conditions</p> <p>In this Sub-Clause, "physical conditions" means natural physical conditions and man-made and other physical obstructions and pollutants, which the Contractor encounters at the Site when executing the Works, including sub-surface and hydrological conditions but excluding climatic conditions.</p> <p>If the Contractor encounters adverse physical conditions which he considers to have been Unforeseeable, the Contractor shall give notice to the Engineer as soon as practicable.</p> <p>This notice shall describe the physical conditions, so that they can be inspected by the Engineer, and shall set out the reasons why the Contractor considers them to be Unforeseeable. The Contractor shall continue executing the Works, using such proper and reasonable measures as are appropriate for the physical conditions, and shall comply with any instructions which the Engineer may give. If an instruction constitutes a Variation, Clause 34/PCC [Variations and Adjustments] shall apply.</p> <p>If and to the extent that the Contractor encounters physical conditions which are Unforeseeable, gives such a notice, and suffers delay and/or incurs Cost due to these conditions, the Contractor shall be entitled subject to Sub-Clause 4.1/SCC [Contractor's Claims] to:</p> <ul style="list-style-type: none"> (a) An extension of time for any such delay, if completion is or will be delayed, under Sub-Clause 26.5/PCC [Extension of Time for Completion], and (b) Payment of any such Cost, which shall be included in the Contract Price. <p>After receiving such notice and inspecting and/or investigating these physical conditions, the Engineer shall proceed in accordance with New-Clause 3.5/PCC [Determinations] to agree or determine (i) whether and (if so) to what extent these physical conditions were Unforeseeable, and (ii) the matters described in sub-paragraphs (a) and (b) above related to this extent.</p> <p>However, before additional Cost is finally agreed or determined under sub-paragraph (ii), the Engineer may also review whether other physical conditions in similar parts of the Works (if any) were more favourable than could reasonably have been foreseen when the Contractor submitted the Bid. If and to the extent that these more favourable conditions were encountered, the Engineer may proceed in accordance with New-Clause 3.5/PCC [Determinations] to agree or determine the reductions in Cost which were due to these conditions, which may be included (as deductions) in the Contract Price and Payment Certificates. However, the net effect of all adjustments under sub-paragraph (b) and all these reductions, for all the physical conditions encountered in similar parts of the Works, shall not result in a net reduction in the Contract Price.</p> <p>The Engineer may take account of any evidence of the physical conditions foreseen by the Contractor when submitting the Bid, which may be made available by the Contractor, but shall not be bound by any such evidence.</p>

New Clause-4.31	<p>Rights of Way and Facilities</p> <p>The Contractor shall bear all costs and charges for special and/or temporary rights-of-way which he may require, including those for access to the Site. The Contractor shall also obtain, at his risk and cost, any additional facilities outside the Site which he may require for the purposes of the Works.</p> <p>In case any operation connected with traffic necessitates diversion, obstruction or closure of any road, railway or any other right of way, the approval of the Engineer and the concerned authorities shall be obtained well in advance by the Contractor.</p> <p>Provided that if it is found necessary for the Contractor to move one or more loads of heavy constructional plants and equipment, materials or pre-constructed units or parts of units of work over roads, highways, bridges on which such oversized and overweight items that are not normally to be moved, the contractor shall obtain prior permission from the concerned authorities.</p> <p>Payments for complying with the requirements, if any, for protection or strengthening of the roads, highways or bridges shall be made by the contractor and such expenses shall be deemed to be included in his quoted contract price.</p>
New Clause-4.32	<p>Avoidance of Interference</p> <p>The Contractor shall not interfere unnecessarily or improperly with:</p> <ol style="list-style-type: none"> a) the convenience of the public, or b) the access to and use and occupation of all roads and footpaths, irrespective of whether they are public or in the possession of the Employer or of others or c) Passenger amenities at stations and station platforms. <p>The Contractor shall indemnify and hold the Employer harmless against and from all damages, losses and expenses (including legal fees and expenses) resulting from any such unnecessary or improper interference.</p>
New Clause-4.33	<p>Access Route</p> <p>The Contractor shall be deemed to have been satisfied as to the suitability and availability of access routes to the Site. The Contractor shall use reasonable efforts to prevent any road or bridge from being damaged by the Contractor's traffic or by the Contractor's Personnel. These efforts shall include the proper use of appropriate vehicles and routes.</p> <p>Except as otherwise stated in these Conditions:</p> <ol style="list-style-type: none"> (a) the Contractor shall (as between the Parties) be responsible for any maintenance which may be required for his use of access routes; (b) the Contractor shall provide all necessary signs or directions along access routes, and shall obtain any permission which may be required from the relevant authorities for his use of routes, signs and directions; (c) the Employer shall not be responsible for any claims which may arise from the use or otherwise of any access route; (d) the Employer does not guarantee the suitability or availability of particular access routes; and

	(e) Costs due to non-suitability or non-availability, for the use required by the Contractor, of access routes shall be borne by the Contractor.
New Clause-4.34	<p>Transport of Goods</p> <p>Unless otherwise stated in the Special Conditions of Contract:</p> <p>(a) the Contractor shall give the Engineer not less than 21 days' notice of the date on which any Plant or a major item of other Goods will be delivered to the Site;</p> <p>(b) the Contractor shall be responsible for packing, loading, transporting, receiving, unloading, storing and protecting all Goods and other things required for the Works; and</p> <p>(c) the Contractor shall indemnify and hold the Employer harmless against and from all damages, losses and expenses (including legal fees and expenses) resulting from the transport of Goods, and shall negotiate and pay all claims arising from their transport.</p>
New Clause-4.35	<p>Contractor's Equipment</p> <p>The Contractor shall be responsible for all Contractors' Equipment. When brought on to the Site, Contractor's Equipment shall be deemed to be exclusively intended for the execution of the Works. The Contractor shall not remove from the Site any major items of Contractor's Equipment without the consent of the Engineer. However, consent shall not be required for vehicles transporting Goods or Contractor's Personnel off Site</p> <p>In the event of Contractor imports any equipment the following shall apply"</p> <p>A. Custom Clearance: The Employer will assist the contractor, when required by furnishing letters of recommendation for obtaining expeditious clearance through customs of constructional plants, material and other things required for the works and then for re-export, if any. The following publications, may be referred to by the contractor for guidance about custom regulations etc :</p> <ol style="list-style-type: none"> i. Import & export policy, together with amendments, if any, published by Govt. of India, Ministry of Commerce.. ii. Hand Book of Procedures, together with amendments, if any, Volume 1 and 2 published by Ministry of Commerce. iii. Customs Tariff, together with amendments, if any published by Central Customs. <p>The Contractor shall be responsible to follow the latest rules and regulations without any liability of the Employer.</p> <p>B. Re-export of contractors equipment: The contractor shall obtain all the relevant information regarding procedure for the import and subsequent re-export of his equipment and materials from the Chief Controller of Imports and Exports, Bangalore, and shall inform himself and keep himself informed on the details of custom charges and draw-back regulations as applicable to the items of Constructional plant. The contractor shall provide the necessary guarantee/bonds where these are required by the customs notwithstanding that import licenses may be granted in the name of Employer.</p> <p>C. Notwithstanding the provisions mentioned above, Contractor's Equipment, including essential spare parts therefore, imported by the Contractor for the sole purpose of executing the Contract shall be temporarily exempt from the payment of import duties and taxes upon initial importation, provided the Contractor shall post with the customs authorities at the port of entry an approved export bond or bank guarantee, valid until the Time for Completion plus six months, in an amount equal to the full import duties and taxes which would be payable on the assessed imported value of such Contractor's Equipment and spare parts,</p>

	<p>and callable in the event the Contractor's Equipment is not exported from the Country on completion of the Contract. A copy of the bond or bank guarantee endorsed by the custom authorities shall be provided by the Contractor to the Employer upon the importation of individual items of Contractor's Equipment and spare parts. Upon export of individual items of Contractor's Equipment or spare parts, or upon the completion of the Contract, Contractor shall prepare for approval by the customs authority the authorities, an assessment of the residual value of the Contractor's Equipment and spare parts to be exported based on the depreciation scale(s) and other criteria used by the customs authorities for such purposes under the provisions of the applicable Laws. Import duties and taxes shall be due and payable to the customs authorities by the Contractor on (a) the difference between the initial imported value and the residual value of the contractor's equipment and spare parts to be exported and (b) on the initial imported value that contractor's equipment and spare parts remaining in the Country after completion of the Contract. Upon payment of such dues within 28 days of being invoiced, the bond or bank guarantee shall be reduced or released accordingly; otherwise the security shall be called in the full amount remaining in the Country.</p> <p>D. Conditions of hire of the contractor's equipment: A certified copy of the agreement in respect of any item of Equipment held by contractor under any agreement for hire or hire purchase thereof, shall be supplied to the Engineer/Employer."</p>
New Clause-4.36	<p>Protection of the Environment</p> <p>The Contractor shall take all reasonable steps to protect the environment (both on and off the Site) and to limit damage and nuisance to people and property resulting from pollution, noise and other results of his operations.</p> <p>The Contractor shall ensure that emissions, surface discharges and effluent from the Contractor's activities shall not exceed the values stated in the Specification or prescribed by applicable Laws.</p>
New Clause-4.37	<p>Electricity, Water and Gas</p> <p>The Contractor shall, except as stated below, be responsible for the provision of all power, water and other services he may require.</p> <p>The Contractor shall be entitled to use for the purposes of the Works such supplies of electricity, water, gas and other services as may be available on the Site and of which details and prices are given in the Specification. The Contractor shall, at his risk and cost, provide any apparatus necessary for his use of these services and for measuring the quantities consumed.</p> <p>The quantities consumed and the amounts due (at these prices) for such services shall be agreed or determined by the Engineer in accordance with New-Clause 2.4/PCC [Employer's Claims] and New-Clause 3.5/PCC [Determinations]. The Contractor shall pay these amounts to the Employer.</p>
New Clause-4.38	<p>Employer's, Equipment and Free-Issue Material</p> <p>The Employer shall make the Employer's Equipment (if any) available for the use of the Contractor in the execution of the Works in accordance with the details, arrangements and prices stated in the Specification. Unless otherwise stated in the Specification:</p> <p>(a) the Employer shall be responsible for the Employer's Equipment, except that</p>

	<p>(b) the Contractor shall be responsible for each item of Employer's Equipment whilst any of the Contractor's Personnel is operating it, driving it, directing it or in possession or control of it.</p> <p>The appropriate quantities and the amounts due (at such stated prices) for the use of Employer's Equipment shall be agreed or determined by the Engineer in accordance with New-Clause 2.4/PCC [Employer's Claims] and New-Clause 3.5/PCC [Determinations]. The Contractor shall pay these amounts to the Employer.</p> <p>The Employer shall supply, free of charge, the "free-issue materials" (if any) in accordance with the details stated in the Contract data.</p> <p>The Employer shall, at his risk and cost, provide these materials at the time and place specified in the Contract. The Contractor shall then visually inspect them, and shall promptly give notice to the Engineer of any shortage, defect or default in these materials. Unless otherwise agreed by both Parties, the Employer shall immediately rectify the notified shortage, defect or default.</p> <p>In case materials are handed over, in accordance with the procedure prescribed by the Engineer, after proper measurement and accounted for, the contractor shall be solely liable for any shortage, damage, defect or default in such material, and shall indemnify the Employer until the final account of materials is made by the Contractor on completion of the work.</p>
<p>New Clause-4.39</p>	<p>Progress Reports</p> <p>Unless otherwise stated in the Special Conditions of Contract, monthly progress reports shall be prepared by the Contractor and submitted to the Engineer in six copies. The first report shall cover the period up to the end of the first calendar month following the Commencement Date. Reports shall be submitted monthly thereafter, each within 7 days after the last day of the period to which it relates.</p> <p>Reporting shall continue until the Contractor has completed all work which is known to be outstanding at the completion date stated in the Taking-Over Certificate for the Works.</p> <p>Each report shall include:</p> <p>Charts and detailed descriptions of progress, including each stage of design (if any), Contractor's Documents, procurement, manufacture, delivery to Site, construction, erection and testing; and including these stages for work by each nominated Subcontractor (as defined in Clause 7/PCC (Nominated Subcontractors)),</p> <p>photographs showing the status of manufacture and of progress on the Site; for the manufacture of each main item of Plant and Materials, the name of the manufacturer, manufacture location, percentage progress, and the actual or expected dates of:</p> <ul style="list-style-type: none"> (i) commencement of manufacture, (ii) Contractor's inspections, (iii) tests, and (iv) shipment and arrival at the Site; <p>the details described in Sub-Clause 1.10/SCC of PCC [Records of Contractor's Personnel and Equipment];</p> <ul style="list-style-type: none"> a) copies of quality assurance documents, test results and certificates of Materials; b) list of notices given under New-Clause 2.4/PCC [Employer's Claims] and notices given under Sub-Clause 4.1/SCC [Contractor's Claims];

	<p>c) safety statistics, including details of any hazardous incidents and activities relating to environmental aspects and public relations; and</p> <p>d) Comparisons of actual and planned progress of all activities, with details of any events or circumstances which may jeopardise the completion in accordance with the Contract, and the measures being (or to be) adopted to overcome delays.</p>
New Clause-4.40	<p>Security of the Site</p> <p>Unless otherwise stated in the Special Conditions of Contract:</p> <p>(a) the Contractor shall be responsible for keeping unauthorised persons off the Site, and</p> <p>(b) authorised persons shall be limited to the Contractor's Personnel and the Employer's Personnel; and to any other personnel notified to the Contractor, by the Employer or the Engineer, as authorised personnel of the Employer's other contractors on the Site.</p>
New Clause-4.41	<p>Contractor's Operations on Site</p> <p>The Contractor shall confine his operations to the Site, and to any additional areas which may be obtained by the Contractor and agreed by the Engineer as working areas. The Contractor shall take all necessary precautions to keep Contractor's Equipment and Contractor's Personnel within the Site and these additional areas, and to keep them off adjacent land.</p> <p>During the execution of the Works, the Contractor shall keep the Site free from all unnecessary obstruction, and shall store or dispose of any Contractor's Equipment or surplus materials. The Contractor shall clear away and remove from the Site any wreckage, rubbish and Temporary Works which are no longer required.</p> <p>Upon the issue of a Taking-Over Certificate, the Contractor shall clear away and remove, from that part of the Site and Works to which the Taking-Over Certificate refers, all Contractor's Equipment, surplus material, wreckage, rubbish and Temporary Works. The Contractor shall leave that part of the Site and the Works in a clean and safe condition.</p> <p>However, the Contractor may retain on Site, during the Defects Notification Period, such Goods as are required for the Contractor to fulfill obligations under the Contract.</p>
New Clause-4.42	<p>Design – General Obligations:</p> <p>Drawings for Permanent works: - DELETED</p> <p>Design, Drawings and Specifications:</p> <p>The Contractor shall Design the proposed track crossing, shifting/modification of LT/HT OH line etc., required to perform their work and shall get the same and related working drawings approved by the Engineer. The Contractor would supply 2 sets of these drawings to the Engineer for the latter's use. The contractor would supply 5 sets of As Erected drawings to the Engineer after final adjustment.</p> <p>Shop Drawings - DELETED</p>
New Clause-4.43	<p>Fossils</p> <p>All fossils, coins, articles of value or antiquity, and structures and other remains or items of geological or archaeological interest found on the Site shall be placed under the care and authority of the Employer. The Contractor shall take reasonable precautions to prevent Contractor's Personnel or other persons from removing or damaging any of these findings.</p> <p>The Contractor shall, upon discovery of any such finding, promptly give notice to the Engineer, who shall issue instructions for dealing with it. If the Contractor suffers delay and/or incurs Cost</p>

	<p>from complying with the instructions, the Contractor shall give a further notice to the Engineer and shall be entitled subject to Sub-Clause 4.1/SCC [Contractor's Claims] to:</p> <p>(a) an extension of time for any such delay, if completion is or will be delayed, under Sub-Clause 26.5/PCC [Extension of Time for Completion], and</p> <p>(b) payment of any such Cost, which shall be included in the Contract Price.</p> <p>After receiving this further notice, the Engineer shall proceed in accordance with New-Clause 3.5/PCC [Determinations] to agree or determine these matters.</p>
	5. PLANT, MATERIALS AND WORKMANSHIP.
New Clause-5.1	<p>Manner of Execution</p> <p>The Contractor shall carry out the manufacture of Plant, the production and manufacture of Materials, and all other execution of the Works:</p> <p>(a) in the manner (if any) specified in the Contract,</p> <p>(b) in a proper workmanlike and careful manner, in accordance with recognised good practice, and</p> <p>(c) with properly equipped facilities and non-hazardous Materials, except as otherwise specified in the Contract.</p>
New Clause-5.2	<p>Samples</p> <p>The Contractor shall submit the following samples of Materials, and relevant information, to the Engineer for consent prior to using the Materials in or for the Works:</p> <p>(a) manufacturer's standard samples of Materials and samples specified in the Contract, all at the Contractor's cost, and</p> <p>(b) additional samples instructed by the Engineer as a Variation.</p> <p>Each sample shall be labelled as to origin and intended use in the Works.</p>
New Clause-5.3	<p>Inspection</p> <p>The Employer's Personnel shall at all reasonable times:</p> <p>(a) have full access to all parts of the Site and to all places from which natural Materials are being obtained, and</p> <p>(b) during production, manufacture and construction (at the Site and elsewhere), be entitled to examine, inspect, measure and test the materials and workmanship, and to check the progress of manufacture of Plant and production and manufacture of Materials.</p> <p>The Contractor shall give the Employer's Personnel full opportunity to carry out these activities, including providing access, facilities, permissions and safety equipment. No such activity shall relieve the Contractor from any obligation or responsibility.</p> <p>The Contractor shall give notice to the Engineer whenever any work is ready and before it is covered up, put out of sight, or packaged for storage or transport. The Engineer shall then either carry out the examination, inspection, measurement or testing without unreasonable delay, or promptly give notice to the Contractor that the Engineer does not require to do so. If the Contractor fails to give the notice, he shall, if and when required by the Engineer, uncover the work and thereafter reinstate and make good, all at the Contractor's cost.</p>
New Clause-5.4	Testing

	<p>This Sub-Clause shall apply to all tests specified in the Contract, other than the Tests after Completion (if any).</p> <p>The Contractor shall provide all apparatus, assistance, documents and other information, electricity, equipment, fuel, consumables, instruments, labour, materials, and suitably qualified and experienced staff, as are necessary to carry out the specified tests efficiently. The Contractor shall agree, with the Engineer, the time and place for the specified testing of any Plant, Materials and other parts of the Works.</p> <p>The Engineer may, under Clause 34/PCC [Variations and Adjustments], vary the location or details of specified tests, or instruct the Contractor to carry out additional tests. If these varied or additional tests show that the tested Plant, Materials or workmanship is not in accordance with the Contract, the cost of carrying out this Variation shall be borne by the Contractor, notwithstanding other provisions of the Contract.</p> <p>The Engineer shall give the Contractor not less than 24 hours' notice of the Engineer's intention to attend the tests. If the Engineer does not attend at the time and place agreed, the Contractor may proceed with the tests, unless otherwise instructed by the Engineer, and the tests shall then be deemed to have been made in the Engineer's presence.</p> <p>If the Contractor suffers delay and/or incurs Cost from complying with these instructions or as a result of a delay for which the Employer is responsible, the Contractor shall give notice to the Engineer and shall be entitled subject to Sub-Clause 4.1/SCC [Contractor's Claims] to:</p> <ul style="list-style-type: none"> (a) an extension of time for any such delay, if completion is or will be delayed, under Sub-Clause 26.5/PCC [Extension of Time for Completion], and (b) payment of any such Cost, which shall be included in the Contract Price. <p>After receiving this notice, the Engineer shall proceed in accordance with New--Clause 3.5/PCC [Determinations] to agree or determine these matters.</p> <p>The Contractor shall promptly forward to the Engineer duly certified reports of the tests. When the specified tests have been passed, the Engineer shall endorse the Contractor's test certificate, or issue a certificate to him, to that effect. If the Engineer has not attended the tests, he shall be deemed to have accepted the readings as accurate.</p>
New Clause-5.5	<p>Rejection</p> <p>If, as a result of an examination, inspection, measurement or testing, any Plant, Materials or workmanship is found to be defective or otherwise not in accordance with the Contract, the Engineer may reject the Plant, Materials or workmanship by giving notice to the Contractor, with reasons. The Contractor shall then promptly make good the defect and ensure that the rejected item complies with the Contract.</p> <p>If the Engineer requires this Plant, Materials or workmanship to be retested, the tests shall be repeated under the same terms and conditions. If the rejection and retesting cause the Employer to incur additional costs, the Contractor shall subject to New-Clause 2.4/PCC [Employer's Claims] pay these costs to the Employer.</p>
New Clause-5.6	<p>Remedial Work</p> <p>Notwithstanding any previous test or certification, the Engineer may instruct the Contractor to:</p>

	<p>(a) remove from the Site and replace any Plant or Materials which is not in accordance with the Contract,</p> <p>(b) remove and re-execute any other work which is not in accordance with the Contract, and</p> <p>(c) Execute any work which is urgently required for the safety of the Works, whether because of an accident, unforeseeable event or otherwise.</p> <p>The Contractor shall comply with the instruction within a reasonable time, which shall be the time (if any) specified in the instruction, or immediately if urgency is specified under sub-paragraph (c).</p> <p>If the Contractor fails to comply with the instruction, the Employer shall be entitled to employ and pay other persons to carry out the work. Except to the extent that the Contractor would have been entitled to payment for the work, the Contractor shall subject to New-Clause 2.4/PCC [Employer's Claims] pay to the Employer all costs arising from this failure.</p>
New Clause-5.7	<p>Ownership of Plant and Materials</p> <p>Each item of Plant and Materials shall, to the extent consistent with the Laws of the Country, become the property of the Employer at whichever is the earlier of the following times, free from liens and other encumbrances:</p> <p>(i) when it is delivered to the Site;</p> <p>(ii) when the Contractor is entitled to payment of the value of the Plant and Materials under Sub-Clause 26.11/PCC [Payment for Plant and Materials in Event of Suspension].</p> <p>Unless otherwise stated in the Specification, the Contractor shall pay all royalties, rents and other payments for:</p> <p>a) natural Materials obtained from outside the Site, and</p> <p>b) the disposal of material from demolitions and excavations and of other surplus material (whether natural or man-made), except to the extent that disposal areas within the Site are specified in the Contract.</p>
	<p>6. Defect Liability</p>
New Clause-6.1	<p>Completion of Outstanding Work and Remedying Defects</p> <p>In order that the Works and Contractor's Documents, and each Section, shall be in the condition required by the Contract (fair wear and tear excepted) by the expiry date of the relevant Defects Notification Period or as soon as practicable thereafter, the Contractor shall:</p> <p>(a) complete any work which is outstanding on the date stated in a Taking-Over Certificate, within such reasonable time as is instructed by the Engineer, and</p> <p>(b) execute all work required to remedy defects or damage, as may be notified by (or on behalf of) the Employer on or before the expiry date of the Defects Notification Period for the Works or Section (as the case may be).</p> <p>If a defect appears or damage occurs, the Contractor shall be notified accordingly, by (or on behalf of) the Employer.</p>
New Clause-6.2	<p>Cost of Remedying Defects</p>

	<p>All work referred to in sub-paragraph (b) of New-Clause 6.1/PCC [Completion of Outstanding Work and Remedying Defects] shall be executed at the risk and cost of the Contractor, if and to the extent that the work is attributable to:</p> <ul style="list-style-type: none"> (a) any design for which the Contractor is responsible, (b) Plant, Materials or workmanship not being in accordance with the Contract, or (c) failure by the Contractor to comply with any other obligation. <p>If and to the extent that such work is attributable to any other cause, the Contractor shall be notified promptly by (or on behalf of) the Employer, and Sub-Clause 34.1/PCC [Variation Procedure] shall apply</p>
New Clause-6.3	<p>Extension of Defects Notification Period</p> <p>The Employer shall be entitled subject to New-Clause 2.4/PCC [Employer's Claims] to an extension of the Defects Notification Period for the Works or a Section if and to the extent that the Works, Section or a major item of Plant (as the case may be, and after taking over) cannot be used for the purposes for which they are intended by reason of a defect or damage. However, a Defects Notification Period shall not be extended by more than two years.</p> <p>If delivery and/or erection of Plant and/or Materials was suspended under Sub-Clause 26.9/PCC [Suspension of Work] the Contractor's obligations under this Clause shall not apply to any defects or damage occurring more than two years after the Defects Notification Period for the Plant and/or Materials would otherwise have expired.</p>
New Clause-6.4	<p>Failure to Remedy Defects</p> <p>If the Contractor fails to remedy any defect or damage within a reasonable time, a date may be fixed by (or on behalf of) the Employer, on or by which the defect or damage is to be remedied. The Contractor shall be given reasonable notice of this date.</p> <p>If the Contractor fails to remedy the defect or damage by this notified date and this remedial work was to be executed at the cost of the Contractor under New-Clause 6.2/PCC [Cost of Remedying Defects], the Employer may (at his option):</p> <ul style="list-style-type: none"> (a) Carry out the work himself or by others, in a reasonable manner and at the Contractor's cost, but the Contractor shall have no responsibility for this work; and the Contractor shall subject to New-Clause 2.4/PCC [Employer's Claims] pay to the Employer the costs reasonably incurred by the Employer in remedying the defect or damage; (b) require the Engineer to agree or determine a reasonable reduction in the Contract Price in accordance with New-Clause 3.5/PCC [Determinations]; or (c) if the defect or damage deprives the Employer of substantially the whole benefit of the Works or any major part of the Works, terminate the Contract as a whole, or in respect of such major part which cannot be put to the intended use. Without prejudice to any other rights, under the Contract or otherwise, the Employer shall then be entitled to recover all sums paid for the Works or for such part (as the case may be), plus financing costs and the cost of dismantling the same, clearing the Site and returning Plant and Materials to the Contractor.
New Clause-6.5	<p>Removal of Defective Work</p> <p>If the defect or damage cannot be remedied expeditiously on the Site and the Employer gives consent, the Contractor may remove from the Site for the purposes of repair such items of Plant as are defective or damaged. This consent may require the Contractor to increase the amount</p>

	of the Performance Security by the full replacement cost of these items, or to provide other appropriate security.
New Clause-6.6	<p>Further Tests</p> <p>If the work of remedying of any defect or damage may affect the performance of the Works, the Engineer may require the repetition of any of the tests described in the Contract. The requirement shall be made by notice within 28 days after the defect or damage is remedied.</p> <p>These tests shall be carried out in accordance with the terms applicable to the previous tests, except that they shall be carried out at the risk and cost of the Party liable, under New-Clause 6.2/PCC [Cost of Remedying Defects], for the cost of the remedial work.</p>
New Clause-6.7	<p>Right of Access</p> <p>Until the Performance Certificate has been issued, the Contractor shall have such right of access to the Works as is reasonably required in order to comply with this Clause, except as may be inconsistent with the Employer's reasonable security restrictions.</p>
New Clause-6.8	<p>Contractor to Search</p> <p>The Contractor shall, if required by the Engineer, search for the cause of any defect, under the direction of the Engineer. Unless the defect is to be remedied at the cost of the Contractor under New-Clause 6.2/PCC [Cost of Remedying Defects], the Cost of the search shall be agreed or determined by the Engineer in accordance with New-Clause 3.5/PCC [Determinations] and shall be included in the Contract Price.</p>
New Clause-6.9	<p>Performance Certificate</p> <p>Performance of the Contractor's obligations shall not be considered to have been completed until the Employer has issued the Performance Certificate to the Contractor, stating the date on which the Contractor completed his obligations under the Contract.</p> <p>The Employer shall issue the Performance Certificate within 28 days after the latest of the expiry dates of the Defects Notification Periods, or as soon thereafter as the Contractor has supplied all the Contractor's Documents and completed and tested all the Works, including remedying any defects.</p> <p>Only the Performance Certificate shall be deemed to constitute acceptance of the Works.</p>
New Clause-6.10	<p>Unfulfilled Obligations</p> <p>After the Performance Certificate has been issued, each Party shall remain liable for the fulfilment of any obligation which remains unperformed at that time. For the purposes of determining the nature and extent of unperformed obligations, the Contract shall be deemed to remain in force.</p> <p>Emergency defect rectification</p> <p>If any defect or damage is one requiring immediate attention from safety, environmental or operational viewpoint, the Engineer has the authority to proceed with rectification in any manner suitable and deduct such sums from the Contract Price</p>
New Clause-6.11	<p>Clearance of Site</p> <p>Upon receiving the Performance Certificate, the Contractor shall remove any remaining Contractor's Equipment, surplus material, wreckage, rubbish and Temporary Works from the Site.</p>

	<p>If all these items have not been removed within 28 days after the Employer receives a copy of the Performance Certificate, the Employer may sell or otherwise dispose of any remaining items. The Employer shall be entitled to be paid the costs incurred in connection with, or attributable to, such sale or disposal and restoring the Site.</p> <p>Any balance of the moneys from the sale shall be paid to the Contractor. If these moneys are less than the Employer's costs, the Contractor shall pay the outstanding balance to the Employer.</p>
	7.MEASURMENT AND EVALUATION
New Clause 7.1	<p>Works to be Measured</p> <p>The Works shall be measured, and valued for payment, in accordance with this Clause.</p> <p>Whenever the Engineer requires any part of the Works to be measured, reasonable notice shall be given to the Contractor's Representative, who shall:</p> <ul style="list-style-type: none"> (a) promptly either attend or send another qualified representative to assist the Engineer in making the measurement, and (b) supply any particulars requested by the Engineer. <p>If the Contractor fails to attend or send a representative, the measurement made by (or on behalf of) the Engineer shall be accepted as accurate.</p> <p>Except as otherwise stated in the Contract, wherever any Permanent Works are to be measured from records, these shall be prepared by the Engineer. The Contractor shall, as and when requested, attend to examine and agree the records with the Engineer, and shall sign the same when agreed. If the Contractor does not attend, the records shall be accepted as accurate.</p> <p>If the Contractor examines and disagrees the records, and/or does not sign them as agreed, then the Contractor shall give notice to the Engineer of the respects in which the records are asserted to be inaccurate. After receiving this notice, the Engineer shall review the records and either confirm or vary them. If the Contractor does not so give notice to the Engineer within 14 days after being requested to examine the records, they shall be accepted as accurate.</p>
New Clause 7.2	<p>Method of Measurement</p> <p>Except as otherwise stated in the Contract and notwithstanding local practice:</p> <ul style="list-style-type: none"> (a) measurement shall be made of the net actual quantity of each item of the Permanent Works, and (b) the method of measurement shall be in accordance with the Bill of Quantities or other applicable Schedules.
New Clause 7.3	<p>Omissions</p> <p>Whenever the omission of any work form's part (or all) of a Variation, the value of which has not been agreed, if:</p> <ul style="list-style-type: none"> a) the Contractor will incur (or has incurred) cost which, if the work had not been omitted, would have been deemed to be covered by a sum forming part of the Accepted Contract Amount; b) the omission of the work will result (or has resulted) in this sum not forming part of the Contract Price; and c) this cost is not deemed to be included in the evaluation of any substituted work;

	then the Contractor shall give notice to the Engineer accordingly, with supporting particulars. Upon receiving this notice, the Engineer shall proceed in accordance with New-Clause 3.5/PCC [Determinations] to agree or determine this cost, which shall be included in the Contract Price.
New Clause 8	<p>FORCE MAJEURE</p> <p>If at any time, during the continuance of this contract, the performance in whole or in part by either party of any obligation under this contract shall be prevented or delayed by reason of any war, hostility, acts of public enemy, civil commotion, sabotage, serious loss or damage by fire, explosions, epidemics, pandemics, strikes, lockouts or acts of God (hereinafter referred to 'events') provided, notice of the happening of any such event is given by either party to the other within 14 days from the date of occurrence thereof, neither party shall by reason of such event, be entitled to terminate this contract nor shall either party have any claim for damages against the other in respect of such non-performance or delay in performance, and works under the contract shall be resumed as soon as practicable after such event has come to an end or ceased to exist, and decision of the Engineer as to whether the works have been so resumed or not shall be final and conclusive, PROVIDED FURTHER that if the performance in whole or in part of any obligation under this contract is prevented or delayed by reason of any such event for a continuous period exceeding 84 days, either party may at its option terminate the contract by giving notice to the other party.</p> <p>Payment and Release in case of Optional Termination</p> <p>Upon such termination, the Engineer shall determine the value of the work done and issue a Payment Certificate which shall include:</p> <ol style="list-style-type: none"> a) The amounts payable for any work carried out for which a price is stated in the contract; b) The Cost of Plant and Materials ordered for the Works which have been delivered to the Contractor, or of which the contractor is liable to accept delivery; this Plant and materials shall become the property of (and be at the risk of) the Employer when paid for by the Employer, the Contractor shall place the same at the Employer's disposal; c) Other Costs or liabilities supported by necessary documentary evidence which in the circumstances were reasonably and necessarily incurred by the Contractor in the expectation of completing the Works as per mutually agreed programme. d) the Cost of removal of Temporary Works and Contractor's Equipment from the Site and the return of these items to the Contractor's works in his country (or to any other destination at no greater cost).
New Clause-9	Defect liability period: 365 Days
New Clause-10	<p>Integrated testing and system commissioning</p> <p>Integrated Testing: Tests on Completion shall also include Integrated Testing. The Contractor shall, following satisfactory completion of tests on his works, equipment, sub-systems or system, perform, at the direction of the Engineer, programme of tests to verify and confirm the compatibility and complete performance of his works, equipment, sub-systems or system with the works, equipment, sub-systems or system provided by others.</p>

	<p>Compilation of Test Results: The results of the Integrated Testing and Commissioning shall be compiled and evaluated by the Engineer and the Contractor</p> <p>Retesting: If the Works, or a part thereof, or a Section, fail to pass the Integrated Testing and Commissioning, the Engineer may order such failed tests to be repeated with the same terms and conditions. If such failure and retesting result from a default of the Contractor and cause the Employer to incur costs, the same shall be recoverable from the Contractor by the Employer, and may be deducted by the Employer from any amount due, or to become due, to the Contractor.</p> <p>Failure to Pass Test: If the Works, or a part thereof, or a Section, fail to pass Integrated Testing and Commissioning and the Contractor in consequence proposes to make any adjustment or modification to the Works or a part thereof, or a section, the Engineer may, with the approval of the Employer, instruct the Contractor to carry out such adjustment or modification, at his own cost and to satisfy the requirements of Integrated Testing and Commissioning within such time as the Employer / Engineer may deem to be reasonable.</p> <p>Statutory Requirements: The Contractor shall carry out all statutory tests and trials, under the supervision of the Engineer, necessary for obtaining sanction of the competent authority for opening the system for public carriage of passengers as mentioned in the Special Conditions of Contract.</p>
<p>New clause-11</p>	<p>Conflict of Interest:</p> <p>The Contractor shall carry out all statutory tests and trials, under the supervision of the Engineer, necessary for obtaining sanction of the competent authority for opening the system for public carriage of passengers as mentioned in the Special Conditions of Contract.</p> <p>Conflict of Interest The remuneration of the Tenderer shall constitute the Tenderer's sole remuneration in connection with this Contract or the Services and, the Tenderers shall not accept for their own benefit any trade commission, discount or similar payment in connection with activities pursuant to this Contract or to the Services or in the discharge of their obligations hereunder, and the Tenderers shall use their best efforts to ensure that any Personnel either of them, similarly shall not receive any such additional remuneration Neither the Tenderer nor the Personnel of either of them shall engage, either directly or indirectly, in any of the following activities:</p> <p>(a) during the term of this Contract, any business or professional activities in India which would conflict with the activities assigned to them under this Contract</p> <p>The tenderer shall not be one of the following:</p> <p>(i) A firm which has been engaged by the Employer to provide consulting services for the preparation related to procurement for or implementation of this project.</p> <p>(ii) Any association/affiliation (inclusive of parent firms) of a firm or an organization mentioned in para (i) above.</p> <p>(iii) A Tenderer who lends, or temporarily seconds its personnel to firms or organizations which were engaged in consulting services for the preparation related to procurement for or implementation of the project, if the personnel would be involved in any capacity on the same project.</p> <p>Jurisdiction of Court in case of dispute or differences arising on account of this tender: Any suit or application, arising out of any dispute or differences on account of this tender shall be filed in</p>

	a competent court at Bangalore, Karnataka only and no other court or any other district of the country shall have any jurisdiction in the matter.
New Clause-12	<p>Special/Acceleration Advance</p> <p>Employer at his sole discretion, may provide Interest bearing Special/Acceleration Advance based on the recommendation of the Engineer to expedite works or to bring forward the completion date(s) and on account of immediate additional mobilization to complete balance works as targeted. The maximum cumulative Special/Acceleration Advance shall be 10% of the Accepted contract amount, which shall be released in stages as and when deemed appropriate as decided by the Engineer/Employer. The advance released at a time shall not exceed 2.5% of the Accepted contract amount.</p>
New Clause-13	<p>Provisional Payment Against Material at Site. -DELETED</p> <p>A provisional payment on account of main construction materials required for the Permanent Works shall be paid in INR only on request of the Contractor after these materials are brought to Site, against the Bank Guarantee and Insurance. The payment shall be limited to 80% of the actual value or assessed value of these materials on the basis of invoice and the total of such provisional payment on account of construction materials at a time shall be limited to three percent of original contract value or likely average consumption of such materials for three months, whichever is less and at any time the total outstanding provisional payment against material at site shall not exceed four percent of the original contract value. The valuation of the average consumption of such main construction materials shall be approved by the Engineer, whose decision shall be final. Materials which are of perishable nature should be adequately insured. Advances and provisional payments as admissible, shall be payable only on Contractor's written request to the Employer/Engineer.</p>
New Clause-14	Ruling Language- English
New Clause-15	Language for communications- English
New Clause-16	<p>Time for access to Site (after the date of commencement)</p> <p>Starting from the Date of Commencement, the section will be progressively handed over in 180 days.</p>
New clause-17	<p>Employers' Bank details for Letter of Credit</p> <p>(a) Nodal Branch Canara Bank, MG Road, Bangalore 560001 IFSC Code – CNRB0002636 A/c No - 0430201012110</p> <p>(b) Issuance/ reimbursing branch for LC Shall be indicated later.</p>

APPENDIX 1

SALIENT FEATURES OF SOME MAJOR LABOUR LAWS APPLICABLE TO ESTABLISHMENTS ENGAGED IN BUILDING AND OTHER CONSTRUCTION WORK

(The laws as current on the date of bid opening will apply)

- a) **Employees Compensation Act 1923:** The Act provides for compensation in case of injury by accident arising out of and during the course of employment.
- b) **Payment of Gratuity Act 1972:** Gratuity is payable to an employee under the Act on satisfaction of certain conditions on separation if an employee has completed 5 years' service or more or on death the rate of 15 days wages for every completed year of service. The Act is applicable to all establishments employing 10 or more employees.
- c) **Employees Provident Fund and Miscellaneous Provisions Act 1952 (since amended):** The Act Provides for monthly contributions by the employer plus workers @ 10% or 8.33%. The benefits payable under the Act are:
 - (i) Pension or family pension on retirement or death, as the case may be.
 - (ii) Deposit linked insurance on the death in harness of the worker.
 - (iii) payment of P.F. accumulation on retirement/death etc.
- d) **Maternity Benefit Act 1951:** The Act provides for leave and some other benefits to women employees in case of confinement or miscarriage etc.
- e) **Contract Labour (Regulation & Abolition) Act 1970:** The Act provides for certain welfare measures to be provided by the Contractor to contract labour and in case the Contractor fails to provide, the same are required to be provided, by the Principal Employer by Law. The Principal Employer is required to take Certificate of Registration and the Contractor is required to take license from the designated Officer. The Act is applicable to the establishments or Contractor of Principal Employer if they employ 20 or more contract labour.
- f) **Minimum Wages Act 1948:** The Employer is supposed to pay not less than the Minimum Wages fixed by appropriate Government as per provisions of the Act if the employment is a scheduled employment. Construction of Buildings, Roads, Runways are scheduled employments.
- g) **Payment of Wages Act 1936:** It lays down as to by what date the wages are to be paid, when it will be paid and what deductions can be made from the wages of the workers.
- h) **Equal Remuneration Act 1979:** The Act provides for payment of equal wages for work of equal nature to Male and Female workers and for not making discrimination against Female employees in the matters of transfers, training and promotions etc.
- i) **Payment of Bonus Act 1965:** The Act is applicable to all establishments employing 20 or more employees. The Act provides for payments of annual bonus subject to a minimum of 8.33% of wages and maximum of 20% of wages to employees drawing Rs.7000/-per month or the minimum wage as fixed by the appropriate government whichever is higher. The Act does not apply to certain

establishments. The newly set-up establishments are exempted for five years in certain circumstances. Some of the State Governments have reduced the employment size from 20 to 10 for the purpose of applicability of this Act.

- j) **Industrial Disputes Act 1947:** The Act lays down the machinery and procedure for resolution of Industrial disputes, in what situations a strike or lock-out becomes illegal and what are the requirements for laying off or retrenching the employees or closing down the establishment.
- k) **Industrial Employment (Standing Orders) Act 1946:** It is applicable to all establishments employing 100 or more workmen (employment size reduced by some of the States and Central Government to 50). The Act provides for laying down rules governing the conditions of employment by the Employer on matters provided in the Act and get the same certified by the designated Authority.
- l) **Trade Unions Act 1926:** The Act lays down the procedure for registration of trade unions of workmen and employers. The Trade Unions registered under the Act have been given certain immunities from civil and criminal liabilities.
- m) **Child and Adolescent Labour (Prohibition & Regulation) Act 1986:** The Act prohibits employment of children below 14 years of age in certain occupations and processes and provides for regulation of employment of children in all other occupations and processes. Employment of Child Labour is prohibited in Building and Construction Industry.
- n) **Inter-State Migrant Workmen's (Regulation of Employment & Conditions of Service) Act 1979:** The Act is applicable to an establishment which employs 5 or more inter-state migrant workmen through an intermediary (who has recruited workmen in one state for employment in the establishment situated in another state). The Inter-State migrant workmen, in an establishment to which this Act becomes applicable, are required to be provided certain facilities such as housing, medical aid, travelling expenses from home up to the establishment and back, etc.
- o) **The Building and Other Construction Workers (Regulation of Employment and Conditions of Service) Act 1996 and the Cess Act of 1996:** All the establishments who carry on any building or other construction work and employs 10 or more workers are covered under this Act. All such establishments are required to pay cess at the rate not exceeding 2% of the cost of construction as may be modified by the Government. The Employer of the establishment is required to provide safety measures at the building or construction work and other welfare measures, such as Canteens, First-Aid facilities, Ambulance, Housing accommodations for workers near the work place etc. The Employer to whom the Act applies has to obtain a registration certificate from the Registering Officer appointed by the Government.

As per Central Government's Notification No.S.O.2899 dated 26.09.1996 under this act, the cess shall be levied @1% of cost of construction works which shall be deducted from each bill of the payment due to the contractor.

- p) **Factories Act 1948:** The Act lays down the procedure for approval at plans before setting up a factory, health and safety provisions, welfare provisions, working hours, annual earned leave and rendering information regarding accidents or dangerous occurrences to designated authorities. It

is applicable to premises employing 10 persons or more with aid of power or 20 or more persons without the aid of power engaged in manufacturing process.

- q) **The Employees State Insurance Act, 1948 (Act No. 34 of 1948) (Provisions as extended from time to time):** An Act to provide for certain benefits to employees in case of sickness, maternity and 'employment injury' and to make provision for certain other matters in relation thereto.

--00--00--00--

K-RIDE

SECTION 8A

EMPLOYER'S REQUIREMENT – GENERAL INFORMATION AND SCOPE OF WORK

INDEX

Table of Contents

SI No	Description	Page No
1	OBJECTIVE	230
2	RELEVANT DOCUMENTS	230
3	GENERAL	230
4	OBTAINING CLEARANCES/CERTIFICATES FROM AUTHORITIES	232
5	INTER COMMUNICATION FACILITIES	233
6	SITE INFORMATION	233
7	RESTRICTIONS IN WORKING	233
8	GENERAL CLIMATIC CONDITIONS	233
9	WORK CONTENT	234-241
10	DAMAGE TO PROPERTY	241-242
11	DRAWINGS	242-243
12	TRAFFIC MANAGEMENT	244
13	LIGHTING AND FIRE PREVENTION	244
14	UTILITIES	244
15	BARRICADING OF SITE AND WORK AREAS	244
16	INTERFACE WORKS	244
17	RESPONSIBILITIES OF CONTRACTOR	244
18	ASSOCIATED WORKS DEEMED INCLUDED IN ITEM RATES OF PERMANENT WORKS	246
19	PENALTY FOR NON-COMPLIANCE	246
20	APPENDIX – 01	248
21	APPENDIX – 02	249
22	APPENDIX – 03	250-251
23	APPENDIX – 04	252-253
24	APPENDIX – 05	254
25	APPENDIX – 06	255
26	APPENDIX – 07	256
27	ANNEXURE-1	257

Section 8A

WORKS/EMPLOYER'S REQUIREMENTS

1. GENERAL INFORMATION & SCOPE OF WORK

Brief Scope

Name of work:

“SHIFTING OF ELECTRICAL UTILITIES INFRINGING PROPOSED CORRIDOR-2 OF BENGALURU SUBURBAN RAIL PROJECT BETWEEN LOTTEGOLAHALLI TO YESWANTPUR OF CHIKKBANAVARA TO BAIYYAPPANA HALLI SECTION”.

The tendered work is part of the Corridor-2 of Bengaluru Suburban Rail Project between BAIYYAPPANA HALLI TO CHIKKABANAVARA. It is proposed to shift/modify the power lines which are infringing to proposed Corridor works between Lottegolahalli to Yeswantpur. The work can be started immediately in order to give the working clearance for the corridor construction works.

The brief scope of work of this tender is shifting of Electrical utilities infringing proposed Bengaluru Suburban Rail Project Corridor-2 from Lottegollahalli to Yeswantpur under C-6. Subdivision of Mathikere O&M Unit & Yeswantapur O&M Unit belongs to BESCO.

1. Modification of over L.T and H.T Lines to Underground Cables in Mohan Kumar Nagar (feeds from 3 feeders-LG Halli ,SBM Colony &VR Layout)

The present power supply arrangement/network at the said location is through HT/LT overhead power line. The same is required to be converted in to underground power supply system by laying HT and LT cables and terminated to the Concerned Compact Sub Station and Ring Main Units.

2. Some of the L.T & H.T Lines should be relocated with P.S.C.C Poles by raising cables or stringing the conductor.
3. Street Light Fitting Arrangements should be made with new PSCC Poles by Providing U.G Cable.
4. Compact Substations of Capacity 800KVA & 500 KVA should be installed by removing 750KVA & 500KVA DTC's throughout the stretch in Lottegollahalli and Mathikere Area.
5. To provide 1 no DAS Specified 5 way RMU ,3 no's of 3 way RMU due to Modification Requirement of O.H lines to U.G Conversion.
5. The L.T Overhead Lines should be Converted with U.G Cable of various size i.e 240,50,25,16sq.mm and provision of L.T feeder Pillar Boxes.
6. The H.T Overhead Lines should be Converted into 400 & 95 Sq.mm Cables.
6. All the Dismantled Materials should be handed over to the Concerned Bescom's stores.

The above installations pertain to BESCO. The work is to be carried out in co-ordination with BESCO and work is to be completed up to the satisfaction of BESCO and the installations are to be handed over to BESCO.

As discussed in above paras, the existing power network is of overhead transmission and distribution. It is proposed to convert the existing arrangement in to UG system in the existing BBMP road. Currently, gas pipe line, water pipe line and sewage pipe line etc., have been laid in the existing BBMP road. While executing the work proper permission from concerned local authorities is to be obtained by the successful tenderer. Utmost care is to be taken while execution of work so that no damages are to be done to existing gas pipe line, water pipe line, sewage line, existing road and safety of road users shall be ensured.

The work has been divided in to four parts i.e Part-A: HT work, Part-B: Compact substation work, Part-C: LT work and Part-D: De-commissioning work. The brief description of scope of work is as follows:

Part-A: HT work

Provision of one no. 5-way RMU (2 OD+3VL), lifting of excess earth up to a distance of 10 kM and earth excavation for RMU foundation, depositing of earth on bank up to lead of 50 mtr with a lift upto 1.5 mtr., lettering the RMU with enamel paint and also writing single line diagram of each panel, caution board, danger board etc. including cost of labor, paint, brush etc. for satisfactory completion of lettering, single line diagram, caution board etc. on RMU, fixing foundation frame of channels and angle iron welding, fixing in concrete, aligning the RMU on foundation bed, providing and laying in position plain cement concrete of mix M-7.5 (1:4:8) with OPC cement @ 180 Kgs, providing and constructing of granite/trap/ballast size stone masonry in foundation cement mortar 1:8 stones, plastering concrete surface in cement mortar 1:4 and 20mm thick inclusive of smooth rendering, supply and laying of 3x400 sq.mm , round armored cable through HDD method with suitable size HDPE pipe, supply of route and joint indicating stones, digging of cable trench, drawing of cable in the trench and RCC pipe reconsolidation of trench and making good the road up to the satisfaction of BBMP, supply and laying of 3x95 sq.mm, round armored and pressure extruded 11 kV class, XLPE cable, supply and making end termination of 3X400 Sq.mm HT XLPE cable with indoor & outdoor type heat shrinkable termination kits, supply and making end termination of 3X95 sq. mm HT XLPE cable with indoor type heat shrinkable termination kits, supply and making straight through, heat shrinkable joint for making cable joint of 3X95 Sq.mm of 11 KV HT XLPE cable, supply and erection of GI pipe of class B, 150mm dia for raising of cable at transformer centers/DP structures/Drainages, earthing of transformers body, transformer's neutral, other metal structures of transformer center.. The detailed specification of items involved in above work is given under section-8B. The cost of above work includes the cost of labor and items required for satisfactory completion of above work.

Part-B: Compact substation work:

Supply, erection, testing and commissioning of 7 No's. 500KVA. 4 No's 800KVA Compact pre-fabricated packaged sub-station 11 kV/433V consisting of 3-way SF6/VCB insulated compact RMU, oil cooled/dry type Cu wound transformer and LT section with one ACB as in coming and 7 No for 500 kVA, 6 Nos. for 800 kVA. outgoing MCCB feeders and with enclosure made of electronically galvanized, 500KVA,800KVA oil cooled transformer, providing and laying in position plain cement concrete of mix M15 (1:2;4), providing and constructing of granite/trap/ballast size stone masonry in foundation cement mortar 1:8 stones hammered and dressed in courses not less than 20 Cms. Height, bond stones at 2

mtr, plastering concrete surface in cement mortar 1:4 and 20mm thick inclusive of smooth rendering of curing etc. complete above ground level, supply and erection of 2 Nos. 11 KV GOS unit consisting of 11 mtr spun pole, three H frame without transformer seating and seating angle support, cross arm for 11 mtr. spun pole structure kit, spun pole cement concreting with coping, HTST with clamps/fish plates, bolts and nuts, 11 kV pin insulator Rabbit conductor for jumpers, 200A single break gang operating switch, HG Fuse unit 11 kV solid core type and 2 Nos. metal oxide type 9 kV lightning arrester with ground disconnecter, construction of Earth pit for Earthing of transformers body, neutral, other metal structures of transformer center etc. The detailed specification of items involved in above work is given in Section 8-B under Technical specification. The cost of above work includes the cost of labor and items required for satisfactory completion of above work.

Part-C: LT work

Supply and laying of 240 sq.mm 3.5 core, 95sq.mm 3.5 core, 50sq.mm 4 core, 25 sq.mm 4 core, 16 sqmm 4 core. 1.1 kV XLPE, armored LT UG cable as per IS-1554 (part-1), armoring strip thickness in average +/- 5% and resistivity of 14 ohms/km (max) as per IS-3975, supply and fixing of feeder pillar box with porcelain rewireable cutout and 1 No. of 630A load break switch with copper bus bar as per IS-13947 Part-1&2, laying of UG cables by trenchless technology by adopting horizontal boring and drawing cable including preparation with suitable size HDPE pipe, earthing of transformers body, neutral, other metal structures of transformer, supply of 240, 95, 50, 25 and 16 sq. mm copper terminals, jointing kits, bolt and nuts required for cable termination and other works, supply and laying of RCC hume pipe, 2000mm long, 150 mm dia with collars, supply and fixing route and joint indicating stones, supply and erection of GI pipe of 150 mm dia for cable rising, supply of MS tubular poles required for street light, supply and fixing of deep drawn / sheet metal lighting metering box with automatic control switch, contactors with automatic control switch with single phase 5-30A meter and 5/50A CT, supply and fixing of LED tube light fitting with tube, supply and laying of 16 sq.mm and 25 sq.mm PVC wire. The detailed specification of items involved in above work is given under section 8-B. The cost of above work includes the cost of labor and items required for satisfactory completion of above work.

Part-D: Decommissioning of Assets:

The Scope of the work includes releasing of DTC 11 KV/433V with oil, -, 250 KVA -7 no's, 500 KVA -5 no's. 4 no's of Lightning Arrestors, Releasing of Rabbit ACSR Conductor of 7 Km. Releasing of GOS Single Break 200A- 48Set's. Releasing of H.G Fuse unit-11unit. To Release Transformer Structure from spun pole of capacity 250 KVA -6 no's. To release Transformer from structure of capacity 200-250KVA- 7 no's, 300-500KVA-5 no's. Releasing of Spun pole of 11 meters-18 no's, R.C.C Poles-128 no's. Releasing of Service mains consumer installation & street light 450 installation's. Releasing of L.T Distribution Box -4 no's. and control box of GSM modem, control Transformer-11no's. The cost of work includes handing over the all released items to BESCO depots at no extra cost of KRIDE. Further, the cost also includes obtaining shut down for HT and LT power supply, liaison/co-ordination with BESCO, GAIL, BBMP etc. for smooth execution of work, transportation charges and other incidental charges for involving in above works.

EMPLOYERS REQUIREMENT - SCOPE OF WORK

1. OBJECTIVE

The tendered work is part of the Bengaluru Suburban Rail Project between chikkbanavara-baiyyappanahalli section. It is proposed to shift/modify the power lines which are infringing to proposed Corridor -2 of Bengaluru Suburban Rail Project. The shifting/modification work is located between Lottegolahalli to Yeswanthpur and it can be started immediately so that the construction works of corridor-2 is planned to start soon.

The objective of the contract is to shift/modify the existing infringing utilities to facilitate smooth execution of Corridor-2 works as stipulated in the contract. In full recognition of this objective, and with full acceptance of the obligations, liabilities and risks which may be involved, the Contractor shall undertake the execution of the Works. The general and specific requirements of the employer are detailed out in this document for understanding of the bidders and for mandatory compliance by the successful bidder/contractor. The Employer's requirements have been divided into different sections / sub-heads for convenience only. They do not restrict any cross-references. The Contractor shall take into account inter-relations between various parts of works. No claim shall be entertained on account of compartmental interpretations.

2. RELEVANT DOCUMENTS

The Engineer shall issue drawings to Contractor for the execution of works in accordance with the agreed terms and conditions of the Contract Agreement.

The following Documents shall be referred in conjunction with each other by the Contractor for construction work as these are mutually complimentary to each other:

- a) Drawings issued by the Engineer
- b) Employer's Requirements as part of Contract
- c) Technical Specifications and explanatory notes to the BOQ, as part of Contract
- d) Bill of Quantities as part of Contract
- e) Indian and International Standards referenced therein.
- f) The schedules and any other documents forming part of the Contract.

The Contractor shall always seek advice from the Engineer in the event of conflicts among above cited documents. In case of conflict, Engineer's decision shall be final and binding.

3. GENERAL

The project site is located in Bengaluru City. The tendered work is associated with Corridor -2 of Bengaluru Suburban Rail Project.

The scope of work includes shifting of electrical utilities which are infringing the proposed Corridor -2 of Bengaluru Suburban Rail Project.

Availability of Land: DELETED

Bidders should inspect the alignment before submission of bid and assess the scope and its associated work. It is the responsibility of the contractor to thoroughly examine the site of work and all constraints before submitting the bid(s).

- i. Before carrying out the work at site, necessary permissions from various local agencies / Railway authorities / road authorities such as SWR, BBMP, BESCOM, PWD, GAIL, Traffic Police etc., shall be required to be obtained by the contractor. The Employer shall assist only by way of issue of necessary support letters.
- ii. Any services affected by the works must be temporarily supported by the contractor. The work of temporarily supporting and protecting the public utility, services during execution of the works shall be deemed to be part of the contract.
- iii. The contractor shall take all precautions for safeguarding the environment during the course of the construction of the works. He shall abide by all laws, rules and regulations in force governing pollution and environmental protection that are applicable in the area where the works are situated. The contractor must take all necessary steps to fix specially dust nuisance during the construction of the works.
- iv. The levels, measurements and other information concerning the existing site as shown on the drawings are believed to be correct, but the contractor should verify them for himself and also examine the nature of the ground as no claim or allowance whatsoever will be entertained on account of any error or omission in the levels or strata turning out different during execution from what is shown on the drawings.
- v. **DELETED**
- vi. The preliminary works such as site clearance, barricading, trail trenching etc., wherever required, shall be taken up simultaneously along with mobilization activities.
- vii. **DELETED**
- viii. The contractor shall at all-time carryout the work on either side of existing IR tracks/ highway/road/service road in a manner creating least interference to the flow of traffic. The contractor shall take prior approval of the Engineer and traffic police regarding traffic arrangements and diversion of traffic during construction.
- ix. All temporary traffic diversion works, which will be required for the smooth flow of running traffic in order to carry out the works without any interruption including all safety precautions, signage, barricading, emergency lighting, traffic marshals, look-out men / watchmen etc.; shall be carried out. The permanent traffic diversions shall be carried out in consultation with traffic police. Contractor has to provide traffic diversion proposals, traffic marshals, cones, traffic diversion boards etc., as desired by Traffic Police.
- x. **DELETED**

- xi. **DELETED**
- xii. **DELETED**
- xiii. Restoration of Road and allied works immediately after completion of work up to road level or as per instructions of Engineer.
- xiv. **DELETED**
- xv. **DELETED**
- xvi. **DELETED**
- xvii. **DELETED**
- xviii. The CONSTRUCTION PROGRAMME AND PROJECT MONITORING is to be given as mentioned in General Conditions of Contract.
- xix. **DELETED**
- xx. Maintaining and keeping the Existing Railway banks, structures and adjacent roads clean in the area of work and where construction machineries ply.
- xxi. Measures to minimize water, air and noise pollution;
- xxii. All aspects of quality assurance, including testing of materials and other components of the work, as specified and as directed;
- xxiii. **DELETED**
- xxiv. Clearing of site and handing over of all the Works, as specified or as directed
- xxv. Maintenance of the completed Work during the maintenance period as directed;
- xxvi. Submission of completion (i.e., 'As-Built') drawings and other related documents as specified; and
- xxvii. The contractor shall not display any name-board for the works without the written permission of the engineer.
- xxviii. No labor camp shall be allowed at work site or any unauthorized place.

4. OBTAINING CLEARANCES/CERTIFICATES FROM AUTHORITIES

The contractor shall arrange well in advance stage wise as may be required, submission of all the required documents and drawings for approval from other authorities and installation of the works and their inspection and obtain approval/completion certificates with respect to his work as required for use and

connection of the utilities and occupation from the Statutory Authorities. The Contractor shall obtain and deliver to the Engineer, on completion of the works, the final Inspection Report and approval from the Authorities.

5. INTER COMMUNICATION FACILITIES

Telephone and fax services are available at Bengaluru. Should the Contractor wish to use Radio communication on the site, the Employer will recommend to the appropriate authority the application for allocation of radio frequencies to the Contractor.

6. SITE INFORMATION-

The project site is located in and around Bengaluru City. Bengaluru is well connected to other parts of the country by Road, Rail and Air. It has an international Airport.

7. RESTRICTIONS IN WORKING

It has to be noted by the Bidder that,

- a. The various items of construction work have to be carried out in narrow roads / streets of Bengaluru city/Beside/across/Parallel to the existing railway line where there are buildings adjacent to the road/track and railway traffic may be heavy.
- b. There are restrictions for movement of trucks and heavy vehicles (ex: trailers) carrying construction materials, cleaning during the day hours on some roads.
- c. There are some one-way roads where traffic can't move in both directions.
- d. Generally, at least two lanes of traffic in both directions have to be kept while the works are on, including foundation works.
- e. Execution of works will have to be planned in such a manner that they do not obstruct or interfere with the existing roads; railways tracks and other utilities.
- f. Where work is required to be carried out at locations adjacent to such Existing IR tracks, roads, utilities, structures, monuments, religious structures, etc., suitable safety and protection arrangements will have to be ensured. Nothing extra will be payable on these accounts. It should also be ensured that no damage is caused to any such element and Engineer/ Employer shall be indemnified against such damage at no extra cost.

8. GENERAL CLIMATIC CONDITIONS

Bengaluru is located in meridians of 12° N latitude and 77°3' E Longitude, spread over an area of 531 sqm km. located at an altitude of 900m, Bengaluru boasts of delightful weather around the year registering maximum temperature of 34° centigrade in summer and minimum temperature of 14° centigrade in winter. Bengaluru receives both the Southwest and Northeast Monsoons, getting an annual

average rainfall of 760 mm, generally during the months of May to September/October. Bengaluru falls in Seismic Zone II

9. WORK CONTENT

9.1 Brief Scope

The proposed work is in connection with the shifting of electrical utilities infringing proposed Corridor -2 of Bengaluru Suburban Rail Project.

- i. Works to be performed shall also include all general works and works of any kind necessary for the due and satisfactory construction, completion and maintenance of the works to the intent and meaning of the drawings adopted and technical specifications, to best Engineering standards and orders that may be issued by the Engineer from time to time, compliance by the agency with all as per Contract document,
- ii. Supply of all materials, apparatus, plant, equipment, tools, fuel, water, transport, offices, stores, workshop, staff, labor and the provision of proper and sufficient protective works, diversion, temporary fencing, lighting and watching required for the safety of the public and protection of works on adjoining land; first-aid equipment, accommodation and sanitation for the staff and workmen, effecting and maintenance of all insurances, the payment of all wages, salaries, provident fund, fees, royalties, duties or the other charges arising out of the erection of works and the regular clearance of rubbish, clearing up, leaving the site perfect and tidy on completion.
- iii. The work to be constructed and maintained as per BOQ, Technical Specification, relevant Codes, and specifications of IS, CPWD, KPWD, BESCO, drawings, best engineering practices and/or as directed by the Engineer.

9.2 The Scope of Civil & Structural works - DELETED

9.3 Civil Formation- DELETED

9.4 Special stipulations/features

Civil Work - DELETED

9.4.6 Power & Traffic Block

- (i) Track occupation may be granted at any time during day or night to suit convenience of traffic operations and will ordinarily be granted over a distance covered by one or two consecutive block sections. Work trains will normally be allowed to take advantage of block shadows. Normally the total duration of block on any section will be maximum of 1.5 to 2.5 hours at a stretch in a day,

once or more than once. Block provided may be utilized for one or more work trains or track Lorries or ladder trolleys to suit convenience of work.

- (ii) Blocks will not ordinarily be given for laying the feeders except where crossing of track is involved, which will have to be laid manually in general.
- (iii) Any traffic / power blocks, temporary speed restrictions and caution orders required in connection with execution of works by the contractor, shall be got sanctioned from the Railway authorities well in advance, through the Engineer. The Railways may sanction the same for specific sites within the overall recovery time available in the Railway time table. The contractor shall have to schedule his programme according to the convenience of the Railways. No claim from the contractor for any delay / inconvenience / loss on this account shall be entertained by the Employer / Engineer.
- (iv) The contractor shall undertake the work involving Railway track, Railway Electrification installations in co-ordination with the Engineer and Railways in accordance with the programme of work. Where traffic / power blocks are involved, the Contractor shall ensure that interruption to Railway operations, if any, is kept to the bare minimum level.
- (v) In order to minimize blocking of the track for work/material trains, the contractor shall consider the working conditions on the section and assess use of alternative method of construction on a part or whole of the work. He should submit clear proposal along with financial implication if any to the purchaser for such special method of saving of blocks that could be obtained along with reduction / redundancy of the facilities being provided by the Railway / K RIDE.
- (vi) The protection required for block working i.e., flagmen, flags etc. shall be provided by the contractor. Competency for the above shall, however, be given by the Railway authority. Protection of track by banner flags etc. shall be done in accordance with General Rules of Indian Railway and Subsidiary Rules of the concerned zonal Railway where work is being carried out. Contractor shall provide Safety helmet, Safety belt and Safety Shoes to their staff while working at site.
- (vii) In case of theft/breakdown, the contractor shall restore the traffic in minimum possible time. Failure to do so shall attract suitable penalty.

9.4.7 Provisional Acceptance

- i) Immediately after completion of works/such part of works, the Contractor shall certify and advise the Engineer in writing that the works are (i) complete (ii) ready for satisfactory commercial service and (iii) ready to be handed over. He will also place at the disposal of the Engineer the required staff for checking it and putting it into operation.
- ii) The test or tests as stipulated in approved Technical Specifications shall be carried out jointly by the Railway / Engineer and the contractor within a month after the receipt of the Contractor's notification as stated in sub-Para above.

- iii) The provisions contained in the relevant GCC clause shall be followed for taking over of the installations.

9.4.8 Use of Rejected/Sub Standard Items/ Equipment

In the event of such rejection as aforesaid, the Engineer shall, without prejudice to his other rights and remedies and in particular without prejudice to his rights under the clause just preceding, be entitled to the use of the rejected/substandard equipment/item for a time reasonably sufficient to enable him to obtain other replacement. During such period, if the rejected/substandard equipment/item is used commercially the Contractor shall not be entitled to the payment on energization until such rejected equipment is rectified and/or replaced, but the Engineer shall not be entitled to claim any damages arising out of rejected/ substandard equipment/item in respect of such period.

9.4.9 Guarantee

- (i) The Contractor shall guarantee satisfactory working of the installations erected by him, for a period of 12 (Twelve) months from the date of commercial operation or from the date of Provisional Acceptance by the Engineer whichever is earlier. The guarantee for spares (if any) should be coincident with the guarantee for erected equipment. The provisions contained in the relevant GCC clause shall be followed for rectification of defects.
- (ii) During the defect liability period the Contractor shall keep available an experienced engineer and necessary equipment to attend to any defective installations resulting from defective erection and / or defects in the equipment supplied by the Contractor. The Contractor shall bear the cost of all modifications, additions or substitutions that may be considered necessary due to faulty materials, design or workmanship for the satisfactory working of the equipment. The final decision shall rest with the Engineer/Employer.
- (iii) During the defect liability period the Contractor shall be liable for the replacement at site of any parts which may be found defective in the equipment whether such equipment be of his own manufacture or those of his sub-contractor whether arising from faulty design, materials, workmanship or negligence in any manner on the part of the Contractor provided always that such defective parts as are not repairable at site are promptly returned to the contractor if so required by him at his (Contractor's) own expenses. In case of type defects in Contractor's equipment and components detected during guarantee period, Contractor should replace all such items irrespective of the fact whether all such items have failed or not. The contractor shall bear the cost of repairs carried out on his behalf by the Engineer at site. In such a case, the Contractor shall be informed about the works proposed to be carried out by the Engineer/Employer.
- (iv) If it becomes necessary for the Contractor to replace or renew any defective portion of the equipment under the Para aforesaid then the provision of the said Para shall also apply to the portions of the equipment so replaced or renewed until the expiration of six months from the date of such replacement or renewal or until the end of the above-mentioned period whichever is later. Such extension shall not apply in case of defects of a minor nature, the decision of the Engineer or his nominee being final in the matter. If any defect be not remedied within a reasonable time during the aforesaid period, the Engineer may proceed to do work at the Contractor's risk and

expense, but without prejudice to any other rights and remedies which the Engineer may have against the Contractor in respect of such defects or faults.

- (v) The repaired or renewed parts shall be delivered and erected on site free of charge to the satisfaction of Engineer/Employer.

9.4.10 **Accountably and disposal of released materials**

- (i) The Contractor shall liaison with the Engineer to finalize the procedure for taking over of the whole or part of the section and for disposal of the released materials.
- (ii) All released materials shall be handed over to the authorized Railway Representative through the Engineer at the nearest OHE/PSI depot/BESCOM/BBMP stores or places nominated by Railway/K RIDE.
- (iii) The material released on account of modifications/alterations shall be accounted by the contractor in the presence of the Engineer and the Railway Representative, except for the material permitted to be re-used by the Engineer. For this material, only erection cost shall be paid, under the appropriate item of the Schedule.
- (iv) If there are any shortages during final reconciliation, their cost will be recovered by the Purchaser from the Contractor at the prices inclusive of all charges as specified in note below: -

If any shortfall of material is noticed at the time of completion of the work, the contractor shall be liable to pay for the shortfall as per book rate or the last purchase rate or the prevailing market rate, whichever is higher, plus 2% on account of incidental charges together with supervision charges at 12.5% of the total cost inclusive of material freight and incidental charges. Freight between the Purchaser's source of supply and the Contractor's depot. The same shall be recovered from the bill of the contractor as per the extant policy of K RIDE.

9.5 **Codes and specifications**

The works shall be carried out as per Standard Specifications of Indian Railways/South Western Railway, which can be obtained on payment. Wherever reference is made in the Contract to specific standards and codes to be met by the goods and materials to be furnished and work performed or tested the provisions of the latest current edition or revision of the relevant standards and codes in effect shall apply, unless otherwise expressly stated in the Contract. Where such standards and codes are national or relate to a particular country or region, other authoritative standards which ensure an equal or higher quality than the standards and codes specified will be accepted subject to the Engineer's prior review and written approval. Differences between the standards specified and the proposed alternative standards must be fully described in writing by the Contractor and submitted to the Engineer at least 14 days prior to the date when the Contractor desires the Engineer's approval. In the event the Engineer determines that such proposed deviations do not ensure equal or higher quality, the Contractor shall comply with the standards specified in the documents.

All goods and materials to be incorporated in the goods be new, unused, and of the most recent or current models, and that they incorporate all recent improvements in design and materials unless provided for otherwise in the contract.

- (a) The Standard Specifications of Indian Railways/South Western Railway/K RIDE and the list of codes and manuals given in the annexure thereof shall be prime governing.
- (b) Where there is conflict between provisions in IRS & IS specifications, provisions in IRS specifications shall prevail.
- (c) Where there is no provision of specifications in IRS, provisions in IS specifications should be adopted. Where there are no provisions in IRS and IS Specifications, provisions should be followed.
- (d) For items not covered in IRS/IS specifications, BS-5400 Part 1 to 10 may also be considered.
- (e) The decision of Engineer shall be final and binding in the interpretation of the clause of the codes of practice and specifications of this tender and no claim whatsoever shall be entertained on this account from the Contractor.

9.6 Survey and fixing working bench marks and alignment markers - DELETED

9.7 Bench marks

- 9.9.1 All along the length of the proposed double line benchmarks have been set up by the Employer at intervals of about a kilometer. The details of these bench marks along with their reduced levels have been marked on the design drawings indicating the plan and 'L' section which form a part of the tender. The contractor along with the Engineer should verify the details of these bench marks in the first instance, soon after taking possession of the site. If any mistakes are detected in these details of these bench marks the same should be indicated to the Engineer. The mistakes detected should be corrected in consultation with the Engineer. These corrections should be got approved by the Engineer before starting of any other work.
- 9.9.2 The contractor shall then in presence of the Engineer establish working bench marks at short intervals, adequately connecting them to the reference bench marks set up by the Employer in the Project length. The working bench mark levels should be got approved from the Engineer. An up-to-date record of all bench marks including approved corrections if any, shall be maintained by the contractor and also the Engineer.
- 9.9.3 All levels taken for making out the longitudinal section and cross section should be related only to these working bench marks.
- 9.9.4 While doing the above-mentioned work, the fact that similar work will have to be done once again on the completed earth work in formation for fixing up the longitudinal levels of the installed P. Way should be kept in view.

9.8 Alignment

- 9.8.1 All along the length of the proposed double line at an interval of about half a kilometer, alignment reference pillars have been set up the Employer; in addition, five reference pillars have been erected for each of the curves to indicate the start & end of the overall length of the curve and its circular portion and apex, by the Employer. In the design drawings showing the plan and 'L' section, which forms part of the tender, the co-ordinates for these pillars have also been given. This has been done to facilitate setting of the alignment of the proposed line. The contractor along with the Engineer should verify the details of these alignment pillars, soon after taking possession of the site. If any mistakes are detected in these details, the same should be indicated to the Engineer before starting any other work. These detected mistakes should be corrected by the Contractor in consultation with the Engineer. These corrections should be got approved from the Engineer.
- 9.8.2 The contractor shall then, in presence of the Engineer, establish working alignment reference markers at shorter intervals, adequately connecting them to the reference pillars set up by the Employer in the Project length. The location of these subsidiary alignment markers should be got approved from the Engineer. An up-to-date record of all alignment pillars, and corrections, if any done, shall be maintained by the contractor and also the Engineer.
- 9.8.3 The alignment for the double line should be related only to these working bench marks.
- 9.8.4 While doing the above-mentioned work, the fact that similar work will have to be done once again on the completed earth work in formation for fixing up the alignment of the installed P. Way should be kept in view.
- 9.8.5 After the formation has been constructed, the center line of track both in Block Sections and Yards should be re-fixed taking guidance from already set up alignment references. Similarly, the rail levels of track both in the block sections and the yards should also be fixed with reference markers. These will be used for installation of track.

9.9 Responsibility for establishing and maintaining working bench marks and alignment markers

- 9.9.1 The Engineer, when necessary, will provide the contractor with the data necessary for setting out of the centerline. All dimensions and levels shown on the drawing or mentioned in the documents forming part of or issued under the contract shall be verified by the contractor on the site; he shall immediately inform the Engineer of any apparent errors or discrepancies noticed in such dimensions or levels. In consultation with the Engineer, the noticed mistakes should be corrected. These corrections should have the approval of the Engineer.
- 9.9.2 The contractor will be entirely responsible for accurate setting out of the works and safeguarding all survey monuments, bench marks, alignment references etc. The work of setting out shall be deemed to be a part of the general works preparatory to the execution of work and no separate payment shall be made for the same
- 9.9.3 The above-mentioned points have been repeated in the respective sections dealing with specifications for different works for laying emphasis on these items.

9.9.4 The contractor will be entirely responsible for accurate setting out of the works and safeguarding all survey monuments, bench marks, alignment references etc. The work of setting out shall be deemed to be a part of the general works preparatory to the execution of work and no separate payment shall be made for the same.

9.10 Issue of materials by Employer

9.10.1 The issue of materials by the Employer to contractor shall be governed by the following change.

9.10.2 The rails and other materials to be issued by the Employer to Contractor will be handed over at any convenient locations within Railway Land in the contract section. The contractor should collect the same from these locations and transport them to the work site as found necessary. He shall use only mechanical means for handling of rails during all stages of work to avoid any damages to the rails. Leading will be paid separately as per relevant item of BOQ.

9.11 Interfacing and Integrations of Works

9.11.1 As a part of provision of this tendered work Modification/shifting of Electrical utilities are to be executed by the successful tenderer. In proposed project area many other agencies are also working. The interfacing for the purpose of integration of works between the Civil or other agencies or between the Contractor and his sub-contractors, (if permitted) will arise. This has to be kept in view.

9.11.2 Land is available throughout the section for carrying out the works. However, if additional land is required in yards/mid-section, necessary arrangements will be made for acquiring the land without affecting the progress of work.

9.11.3 The contractor shall take full responsibility in terms of organizing, managing, coordinating and administrating the interfacing of all components of works including all issues related to and arising out of such tasks and responsibility. The contractor shall interface with all concerned authorities and other contractors as required to complete the work satisfactorily within the stipulated period.

9.11.4 Under consideration and application of the above clause, the contractor shall and has also the obligation to liaise with the other contractors and Authorities to obtain all necessary technical information, all necessary information concerning organization of works, coordinating the works etc. which are necessary to assess, mitigate, take care of contractual obligations, risks, liabilities and whatsoever arising out of interfacing, engineering issues, organization of the works etc. The employer/engineer shall not be held liable in any way, throughout the preparation of the offer and/or execution of the works and/or maintenance period and/or defects liability period for any omissions, misunderstanding, negligence etc. arising out of interfacing, coordinating, organizing etc. of the works. The employer will not entertain any claim arising out of misunderstanding, miscommunication, omission, withholding of necessary/required information or whatsoever between the concerned contractors/Authorities concerning interfacing, organizing etc. of works. In case of any claim arising from any of the contractors, as aforesaid, referring to interfacing and/or interfacing related issues; the Employer will hold the concerned contractors liable for not taking care of their contractual obligation concerning interfacing, organizing, co-ordination etc. of the related works.

- 9.11.5 Needless to say, that commissioning of this double line project requires close coordination among various agencies executing the works in this section, Engineer, Employer and the Railway authorities. The contractor shall therefore plan all his works requiring interfacing, like works in mid-section, station yards, with other agencies, meticulously, in consultation and coordination with all concerned parties, in advance, for expeditious execution, without causing any delay either to his works or those of others.
- 9.11.6 If, in the opinion of Engineer, any delay in execution of any part of the Project requiring interfacing is attributable to the failures of the contractor to take adequate steps for smooth execution of such works, then the Engineer shall have the right to take necessary steps to organize and streamline such works, including excluding the requisite portion of work from the scope of the Contractor and getting the same executed by other agencies, at the risk and cost of the contractor.

10.0 **DAMAGE TO PROPERTY**

The contractor shall organize all his activities so as not to cause any damage to the property of Railway or that of other agencies or any third party. In spite of taking all precautions, in the unfortunate event of any damage to the property, then the contractor shall not only indemnify the Employer of the claims made by the affected parties but also settle the matters with the affected parties as per law. If the nature of damage is one of that affecting the train movements or causing a safety hazard to the public, then the situation will be treated as an emergency and the Engineer reserves the right to take all necessary steps as deemed necessary to restore train operations or to remove the hazardous situation or to mitigate the damage, at the risk and cost of the contractor.

All power requirements for execution of works shall be arranged by the Contractor from his own resources. Subject to availability of power, the Employer/Engineer will recommend to the Railway Authorities for providing power connection. The Contractor shall bear the cost of installation and payment of necessary charges for providing such power connections as per the Terms and Conditions of the Railway.

10.1 **Survey Equipment**

The contractor should provide the survey equipment and other accessories as per the instructions of Engineer as and when required. He should also provide all necessary help as required by the Engineer for checking the works, whenever required.

- 10.2 All power requirements for execution of works shall be arranged by the Contractor from his own resources. Subject to availability of power, the Employer/Engineer will recommend to the Railway Authorities for providing power connection. The Contractor shall bear the cost of installation and payment of necessary charges for providing such power connections as per the Terms and Conditions of the Railway.

10.3 **Structural elements, shape and form - DELETED**

10.4 **Stability of the elements - DELETED**

10.4 **Stability of the Structure - DELETED**

10.6 Temporary Works

Traffic barricade with reflective tapes and other necessary traffic signages should be provided wherever required so that safety is ensured during day and night continuously. Temporary traffic diversion for smooth flow of traffic during construction including necessary traffic signs, repairs to the diverted route/service lanes, if required, restoration of diverted route to original condition etc. shall be done by contractor at his cost. Contractor shall also provide any temporary support for the utilities (charted or uncharted), wherever required, at no extra cost to Employer. The above listed works are only brief but the actual scope of work shall be as specified in the concerned document and/or as specified or directed by the Engineer.

10.7 Design for Temporary Works

The Design should cover all the items pertaining to all temporary works, traffic diversion scheme, launching scheme for RCC pole / OH conductor stringing/ cable laying or transportation scheme for various structural elements and materials to be transported to and from site during construction period.

The Contractor shall himself formulate a practical and viable scheme for design/ fabrication of shuttering, casting, curing, testing and launching/erection of poles/ stringing of conductor/ cable laying and all other structures. The bidder should, along with the bid, specify the scheme that he proposes to adopt for carrying out all the works including fabrication, transportation, stacking and erection of steel structure and casting, curing, stressing, testing and erection of poles / stringing of conductor.

The contractor shall formulate the erection scheme in accordance with relevant provision of applicable standards and submit the same to the Engineer for approval with third party certificates. These works will be executed only after the approval has been obtained from Engineer.

11. DRAWINGS - DELETED

11.1 GFC Drawings: - DELETED

11.2 Meaning and intent of specifications and Drawings:

If any ambiguity arises as to the meaning and intent of any portion of the specifications and drawing or as to execution or quality of any work or material, or as to the measurement of the works, the decision of the Engineer thereon shall be final subject to the appeal (within 7 days of such decision being intimated to the Contractor) to Engineer/Employer who shall have the power to correct any errors, omissions, or discrepancies in the specifications, drawings, classifications of works or materials and whose decision in the matter in dispute or doubt shall be final and conclusive.

11.3 Responsibility for Specifications.

a) Specifications

RDSO/ CPWD, KPWD, BESCO specification / other Specifications / Codes viz. IS etc. shall be procured by the Contractor from the market. One set of these specifications shall always be kept at contractor's site office for reference.

Standards guaranteeing a level of quality or performance equivalent or superior to those indicated will also be accepted. Reference to trademarks or other specific designations that is necessary to explain the nature of the products required means that any other product of equal or superior quality or performance is also acceptable, subject to prior approval of the ENGINEER to be obtained in writing for adopting the new standards which are not provided in the contract.

b) Drawings for Permanent Works: - DELETED

c) Design, Drawings and Specifications for Temporary/ Ancillary works. -

- a) All Drawings shall be prepared on CAD using AUTO-CAD Version 2010 or Higher Plan, elevation and side view for proposed track crossing/modification and other HT/LT modification/shifting.

d) Completion Drawings

On completion of the work in all respects the contractor shall submit the following

- i. Five sets of "As Erected Drawings" in the standard sizes of A0, A1, A2, A3 or A4 Roll each containing complete set of drawings for every component of work on approved scale indicating the work "As Erected". Each set shall also contain technical literature.
- ii. These drawings shall be prepared on CAD using Auto-Cad version (latest/as directed by Engineer) and shall be recorded on writable CDs and one set of these CDs shall also be submitted.
- iii. The Contractor shall also submit one set of original "As Erected" drawings on polyester film or as directed by Engineer of quality as approved by Engineer/ Engineer's Representative.

The Certificate of Completion of Works as per the provisions in the General Conditions of Contract shall not be issued by the Engineer in the event of Contractor's failure to furnish aforesaid "As Erected" drawings for the entire works.

e) Plans and Drawings for Layout of Plant and Equipment - DELETED

12. TRAFFIC MANAGEMENT - DELETED

13. LIGHTING AND FIRE PREVENTION - DELETED

14. UTILITIES - DELETED

14.1 Damage to Utilities

The contractor shall be responsible for any theft, damage and / or protection of all the existing utilities within the site of work during currency of the Contract. In case of any theft/ damage occurring to these utilities while working or otherwise, the contractor shall immediately inform the Engineer's representative as well the utility owning agency and restore the same immediately to the entire satisfaction of the utility owning agency. Any damage due to working / negligence / fault of the Contractor (decision of Engineer in this regard shall be final and binding), the same shall be repaired / made good by the Contractor at his own cost. Any damage/ compensation / penalty etc. if charged by the utility owning agency in this regard shall also be payable by the Contractor and no claim in this regard shall be entertained by the Employer. Contractor shall always keep indemnified the Engineer / Employer against this.

15. BARRICADING OF SITE AND WORK AREAS

The contractor shall provide temporary barricade during construction at site, work areas (i.e., construction Depot, Store, Site office, Casting yard etc.,)

16. INTERFACE WORKS

In addition, the Contractor shall be required to carry out various interface works as per interfacing requirements. Such as interfacing with various contracts of signaling & Telecommunication, traction power & power supply, track work, rolling stock etc.,

17. RESPONSIBILITIES OF CONTRACTOR

17.1 The Contractor shall liaison with ESCOM/ KPTCL/ PGCL, State/Central Government and local bodies till completion of works in all respect. It is the responsibility of the contractor to ensure proper liaison and co-ordination with State Authorities for availing line clearance, joint inspection, testing & commissioning energization of in to the full satisfaction of State Authorities and handing over, and KRIDE intervention should not be sought for any of the above.

17.2 ROW issues if any shall be sorted out by the contractor.

17.2.1 It is the responsibility of the Successful contractor to liaison with EB authorities for arranging joint inspections along with KRIDE supervisor as and when required and to ensure for early preparation of estimations, obtaining approvals at various stages, getting sanctioning of estimations and supervision charges intimations, collection of work orders (Modification work of HT/LT power line crossings, Additional load/ Availing new power supply for railway installations etc).

17.2.2 In connection with the work Contractors has to liaison with EB authorities / statutory authorities in getting the intimations towards the payment of the following and submit the same to this office in time to facilitate for processing the payment by Railway.

- a. Availing of new supply/service connection charges/deposit.
- b. Supervision charges (10% of estimate or latest as per EB guidelines) based on sanctioned estimate of ESCOM / KPTCL / PGCL authorities along with copy of sanctioned estimate.
- c. The contractor shall coordinate for payment of "Supervision Charges" to electricity authority and other charges payable to individual Govt. agencies as per the prevailing government rules, such payment shall be paid by KRIDE.

17.2.3 KRIDE will pay necessary statutory Charges, supervision charges, related ROW charges, Electrical inspectorate and inspection charges payable to ESCOM. Charges of stamp duties /agreements, TAQC/ MR charges as applicable and any other incidental charges payable to ESCOM / KPTCL/ PGCL / BBMP, GAIL, BWSSB, BDA, to be borne by contractor.

17.2.4 Execution of agreement with KRIDE / Railways and SEB authorities/ DISCOM submitting Relevant documents for EIG approval as per the requirement. It is the responsibility of the contractor for proper handing over of released materials to State Authorities. For this purpose, it is suggested that a joint inspection with the State Authorities officials concerned shall be carried out, the items and quantities of materials to be released are assessed properly before the work is started.

17.2.5 Safe guarding the environment**17.2.6 The contractor shall carry out expeditiously and without delay the following works**

- a. Identify and get approved the sources of various major construction materials.
- b. Material testing and mix designs of concrete as contemplated in the specifications.
- c. Any other pre-requisite items required for final execution.
- d. Any other items specified in other sections of contract.

18. ASSOCIATED WORKS DEEMED INCLUDED IN ITEM RATES OF PERMANENT WORKS

18.1 Contractor's Organization and Plant & Equipment

Project Organization Plan

- (1) The Contractor's Personnel shall be deployed & maintained in consultation with Engineer and as per the requirements. The Contractor's Superintendence shall be also properly deployed and maintained to carry out the construction activities as described in the relevant General Conditions of Contract (GCC) clause.
- (2) The Contractor shall submit an updated Project Organization Plan which includes complete project organization chart during the Construction adding functions and personnel necessary to perform the Works during the Construction in accordance with the conditions of the Contract. This plan shall be updated and resubmitted whenever there are changes to the staff and / or the organizational structure. The plan shall show the management structure and state clearly the duties, responsibilities and authority of key staff member.
- (3) The contractor shall deploy the key personnel of requisite qualification and experiences. In case Engineer instructs (in writing) the Contractor to remove a person of his work force stating the reasons, the Contractor shall ensure that the person leaves the Work Area within seven days and shall have no further connection with the Works in the Contract. The Engineer shall also seek prior consent of the Employer in this regard.
- (4) The minimum requirements for man-power are attached as **Appendix [Organization charts and key positions]** to the Employer's Requirement.

Plant and Equipment

- a) The minimum Plant and equipment as shall be maintained in consultation with Engineer and as per the requirements.
- b) The minimum requirements for plant & equipment are attached as **Appendix 5 [Plant and Equipment]** to the Employer's Requirement.

19. PENALTY FOR NON-COMPLIANCE

Notwithstanding the provisions elsewhere in the bid documents, the Contractor shall be penalized as detailed below:

a) Correction of Defects

If the Engineer determines that any item or part of it was constructed with bad workmanship and / or using sub-standard construction materials,

Sl. No.	Nature of Defects	Penalty (Rs.)
1.	Not adhering safety guidelines as mentioned in the tender document	10,000/- each case
2	Usage of non-approved / sub-standard materials	25,000/- each case

The above said penalty is envisaged to act as deterrent against bad workmanship and usage of sub-standard construction materials by the Contractor and shall be imposed for every occurrence. These penalties are non-refundable.

K RIDE

Appendix 01

1. PROGRAMME REQUIREMENTS

1.1 General

1.1.1 Construction programme and project monitoring

- a) The contractor shall propose and submit his detailed Shifting / Modification plan separately and as per the procedure detailed in the scope of work. Contractor may be asked to schedule and complete the work block wise / area wise in a phased manner fixing priorities to different stretches of the work to give access to other interfacing contracts as mentioned in the Bid documents.
- b) The tentative Shifting / Modification plan shall be submitted within the period as specified in the Bid document for approval of the Engineer as 'Baseline Program'.
 1. After the work has started, the Contractor shall deliver in the first week of every month to the Engineer an update of the Shifting / Modification plan showing changes, if any, in planning or progress scheduling and reflecting the progress of all the activities of the network and the project status as at the end of previous month.
 2. If the Contractor falls behind the approved Shifting / Modification program plan by more than one month, he shall, within fourteen days of the date of such information, submit for approval, a revision of the Shifting / Modification plan showing the proposed measures, including augmentation of plant, labor and material resources to complete the works on time.
 3. Whenever the Contractor proposes to change the Shifting / Modification plan, he shall immediately advise the Engineer in writing and, if the Engineer considers the change a major one, the Contractor shall submit a revised program for approval.

4. DELETED

Appendix-02

DELETED

K RIDE

Appendix-03

Quality Assurance Materials

a. All the equipment, materials, fittings and components will be subject to quality control programme of the manufacturer, being part of the quality Assurance programme of the Contractor. The materials may also be inspected by the Purchaser or his representative either at the manufacturer works or at the Contractor's depot. The Purchaser or his representative shall have the right to be present during all the stages of manufacture and shall be accorded free of charge all reasonable facilities for inspection and testing as well as to examine the stage inspection report of the manufacturer in addition to the quality audit which the Contractor may institute as a part of his programme so as to satisfy himself that the materials are in accordance with specifications, approved drawings and designs and Purchaser's prescribed quality Assurance Standards.

b. **Erection**

All erection work will also be subjected to the Quality Assurance Programme including inspection by the Purchaser or his representative to ensure that the work is done in accordance with the specifications and approved drawings and designs and Purchaser's prescribed Quality Assurance Standards.

(c) **Expenses of Purchaser's Representative- DELETED**

d. The decision of the Purchaser or his representative shall be final in respect of acceptability or otherwise of any material, fittings, components or equipment's required for the work.

e. **Quality Assurance Programme**

For proper control of quality and to ensure that the materials, equipment's and fittings are manufactured according to specification and the erection is according to approved instructions, ensure quality at all necessary points, whether at manufacturer's works, or in his depot or at work site as well as during erection. Such quality assurance programme shall also meet the requirement of the Purchaser's Prescribed Quality Assurance Standards. This programme of the Contractor shall generally cover the following:-

1. The organization to manage and implement the Quality Assurance programme.
2. The documentation control system: -
 - i) Basic control system.
 - ii) Adopted at manufacturer's works.
 - iii) Adopted at the Contractor's Depot and work site.
3. Procedure adopted for :-
 - i) Source Inspection.
 - ii) Incoming raw material inspection.
 - iii) Verification of materials purchased.
 - iv) Fabrication controls.
 - v) Site erection controls.
4. Inspection and Test Procedure for :-

- i) Manufacture and quality control procedure.
 - ii) Field activities.
- 5. System of handling and storage.
- 6. System of quality audit.
- 7. System of maintenance of records.
- 8. For the purpose of obtaining ' On Account Payment ' the Contractor shall submit along with the invoice, the documents indicated in the Prescribed Quality Assurance Standard which should inter-alia cover the following as may be applicable in each case.
 - i) Material test reports on raw materials used.
 - ii) Material type and routine test report on components specification.
 - iii) Inspection plan with reports of the Inspection plan check points.
 - iv) Routine test report.
 - v) Factory test results as required under the specification.
 - vi) Quality audit report including test check report of Purchaser's representative if any.

K R I D E

Appendix-04

ORGANISATION CHART AND KEY POSITIONS

The Contractor shall provide the following organization chart for the Works as follows:

Head office Organization Chart

One organization chart shall be provided for the Contractor head office indicating the management and staff structure, with responsible personnel/departments described for all aspects of the work.

Site organization Chart

The Contractor shall provide the proposed site organization indicating the proposed structure, staff partners and positions necessary to adequately manage and control the Works.

The Contractor shall have a competent team of Managers, Engineers, Technical staff etc. so as to complete the work satisfactorily as per various requirements of the contract.

The Key Positions not limited to and corresponding qualification and experience are as under:

S. No.	Position	Minimum No. of Personnel	Qualification	Minimum Experience in Similar Work [years]
1	Sr. Engineer	1	Graduate in Electrical Engg.	Min. 5 Years
2	Sr. Engineer	1	Diploma in Electrical Engg.	Min, 10 years for Diploma
3	Technicians/ Electricians	3	ITI in Electrician	Min. 5 Years

NOTES:

- The above categories of key positions shall be minimum required for successful completion of the work which shall be deployed at different points of time as per the progress and requirement of work and may not be required to deploy simultaneously and continuously. However, these personnel shall be deployed at site in advance as per requirement and as directed by the Engineer and the decision of Engineer in this regard shall be final and binding.
- The Contractor shall submit the CVs of the above key positions to Engineer for his approval within 28 days of issue of letter of Acceptance (LOA).

3. The contractor shall deploy resources as per the above-mentioned minimum requirement and also confirm to deploy manpower over and above the minimum numbers indicated above, if the work requires so.
4. The performance of project personnel deployed will be evaluated periodically by Employer during the contract period. In case the performance of any of the project personnel is not satisfactory, the Contractor shall replace them with better or equivalent personnel immediately as per directions of the Engineer.
5. Tenderer may propose any number of names of Personnel for each Key Position. Any of the proposed personnel as approved by the Employer for each key position have to be mandatorily deployed in case of award of work.
6. Non-deployment of the Key personnel sl. no 1 and 2 leads to imposition of Penalty of Rs 25,000 /- Per Key personnel per month.
7. The proposed Key personnel are not to be changed till the completion of the work. Under emergent circumstances, in case they are required to be changed, the new incumbent should have similar or better experience and qualification than as required above. These changes are permitted only with the approval of the Employer. Change in key personnel for one time without penalty is permitted. However, for subsequent changes there will be Penalty at Rs 25,000 /- Per Key personnel for Sl. no 1 & 2.
8. All Key Personnel must be permanently stationed at Bangalore till the completion of the work.
9. The penalties imposed are non-refundable.

Appendix-05

PLANT AND EQUIPMENT**Tools for Electrical Utility Shifting Works**

Sl.no	Item Description	Unit	Qty
1	Welding Machine	No's	1
2	Electric Hand Driller	No's	3
3	Digital Multi meter	No's	2
4	Insulation Megger	No's	2
5	Digital Earth Tester	No's	2
6	Ladder	No's	4
7	Hand Tool Kit	No	1
8	Crimping Tool	Each	1
9	Set of Tool Socket Spanner	No	1

NOTES:

1. The above type of plant and equipment (but not limited to) may be required for execution of the work. The contractor shall submit the details of plant & equipment to be deployed in the above table within 28 days of issue of LOA to the Engineer for approval.
2. Plant and Equipment indicated above is minimum to be deployed at appropriate stage of the work. However, depending on the requirement to complete the work in the stipulated completion period, the tenderer should deploy additional machinery as circumstances warrant at no extra cost.
3. Plant and equipment to be mobilized for the work shall be in good serviceable condition.

Appendix-06

OFFICE ACCOMMODATION, EQUIPMENT AND TRANSPORT - DELETED

K RIDE

APPENDIX 7: DOCUMENT SUBMISSION AND RESPONSE PROCEDURE

DELETED

K RIDE

ANNEXURE 1

The Contractor shall prepare and submit his detailed Programme of Work so as to achieve key dates of various activities on time. The Contractor shall complete the work in a phased manner by fixing priorities to different stretches of work to give access to the other interfacing contractors as per the requirement of project from time to time and as per the key dates (mile stones) indicated below:

Name of Work

“SHIFTING OF ELECTRICAL UTILITIES INFRINGING PROPOSED CORRIDOR-2 OF BENGALURU SUBURBAN RAIL PROJECT BETWEEN LOTTEGOLAHALLI TO YESWANTPUR OF CHIKKBANAVARA TO BAIYYAPPANA HALLI SECTION”.

Key Dates No.	Description of stage	Liquidity Damages for non-achieving the key dates
KD 1	Joint inspection of site/locations along with K-RIDE officials	0.01% of contract value for each week or part of the week
KD 2	Processing of case papers for consent of modification of BESCO power lines.	0.01% of contract value for each week or part of the week
KD 3	Start modification/construction work	0.01% of contract value for each week or part of the week
KD 4	Completion of modification/construction work	0.01% of contract value for each week or part of the week
KD 5	Arranging EIG inspection wherever required.	0.01% of contract value for each week or part of the week
KD 6	Obtaining EIG approval and charging of power line and handing over to BESCO authorities	0.01% of contract value for each week or part of the week

--00--00--00--

SECTION 8A-1: GENERAL REQUIREMENT

SL. NO	DESCRIPTION	PAGE NO.
1	CARE OF THE WORKS	259
2	PROTECTION OF THE WORKS FROM WEATHER	259
3	PROTECTION OF THE FINISHED WORK	260
4	DAMAGE AND INTERFERENCE	260
5	STRUCTURES, ROADS AND OTHER PROPERTIES	260
6	ALTERNATIVE ACCESS	260
7	TRANSPLANTED / CUTTING OF TREES	261
8	REMOVAL OF GRAVES AND OTHER OBSTRUCTIONS	261
9	PROTECTION THE ADJACENT STRUCTURES AND WORKS	261
10	SITE ESTABLISHMENT	262
11	SUBMISSIONS OF PARTICULARS	262
12	SECURITY	262
13	RECORDS OF WAGE RATES	262
14	PROVISION AND DISPOSAL OF EARTHWORKS / MATERIALS	262
15	RESTORATION OF AREAS DISTURBED BY CONSTRUCTION	262
16	CONTRACTOR'S LABOUR CAMPS	263

GENERAL REQUIREMENTS – CONSTRUCTION

1.0 CARE OF THE WORKS

- 1.1 Any error in the execution of work leading to redesign work shall be duly compensated by the Contractor as per the decision of Engineer. Any error attributable to the construction including Failure to locate underground utilities shall attract penalties.
- 1.2 Unless otherwise permitted by the Engineer all works shall be carried out in dry conditions.
- 1.3 The Works, including materials for using in the Works, shall be protected from damage due to water. Water on the Site and water entering the Site shall be promptly by temporary drainage or pumping system or by other methods capable of keeping the Works free of water. Silt and debris shall be removed by traps before the water is discharged and shall be disposed of at a location or locations to which the Engineer has given his consent.
- 1.4 The discharge points of the temporary systems shall be as per the consent of the Engineer. The Contractor shall make all arrangements with and obtain the necessary approval from the relevant authorities for discharging water to drains, watercourses etc. The relevant work shall not be commenced until the approved arrangements for disposal of the water have been implemented.
- 1.5 The methods used for keeping the Works free of water shall be such that settlement of, or damage to, new and existing structure does not occur. Measures shall be taken to prevent flotation of new and existing structures.

2.0 PROTECTION OF THE WORKS FROM WEATHER

- 2.1 Work shall not be carried out in weather conditions that may adversely affect the Works unless proper protection is provided to the satisfaction of the Engineer.
- 2.2 Permanent Works, including materials for such Works, shall be protected from exposures of weather conditions that may adversely affect such Permanent Works or materials.
- 2.3 During construction of the Works storm restraint systems shall be provided where appropriate. These systems shall ensure the security of the partially completed and ongoing stages of construction in all weather conditions. Such storm restraint systems shall be installed as soon as practicable and shall be compatible with the right of way, or other access around or throughout the Site.
- 2.4 The Contractor shall at all times programme and carry out the work duly ensuring protective arrangements such that the Works can be made safe in the event of storms.

3.0 PROTECTION OF THE FINISHED WORK

3.1 The finished Works shall be protected from any damage that could arise from any activities on the adjacent site / works.

4.0 DAMAGE AND INTERFERENCE

4.1 Work shall be carried out in such a manner that there is no damage to or interference with: -

- a. Watercourses or drainage systems:
- b. Utilities:
- c. Structures (including foundations), roads, including street fixtures, or other properties: d
Public or private vehicular or pedestrian access:
- e. Monuments, temples, graves or burial grounds other than to the extent that is necessary for them to be removed or diverted to permit the execution of the Works. Heritage structures shall not be damaged or disfigured on any account.

The Contractor shall inform the Engineer as soon as practicable of any items which are not stated in the Contract to be removed or diverted but which the Contractor considers necessary to be removed or diverted to enable the Works to be carried out. Such items shall not be removed or diverted until the consent of the Engineer to such removal or diversion has been obtained.

4.2 Items which are damaged or interfered with as a result of the Works and items which are removed to enable the Works to be carried out shall be reinstated to the satisfaction of the Engineer and to at least the same condition as existed before the Work started. Any claims by Utility Agencies due to damage of utilities by the Contractor shall be borne by the Contractor.

5.0 STRUCTURES, ROADS AND OTHER PROPERTIES

5.1 The Contractor shall immediately inform the Engineer of any damage to structures, roads or other properties.

6.0 ALTERNATIVE ACCESS

6.1 Alternative access shall be provided to all premises if interference with the existing access, public or private is necessary to enable the Works to be carried out. The arrangements for the alternative access shall be as agreed by the Engineer and the concerned agency and at contractor's cost. Unless agreed otherwise, the permanent access shall be reinstated as soon as practicable after the work is complete and the alternative access shall be removing immediately it is no longer required, and the ground surfaces reinstated to the satisfaction of the Engineer. Proper signage and guidance shall be provided for the traffic / users regarding diversions. All temporary access diversion and roads

the contractor has to arrange at his own cost.

7.0 TRANSPLANTED / CUTTING OF TREES

7.1 The felling of trees in the Bangalore City is governed by The Karnataka preservation of Trees Act 1976. The Contractor is not permitted to cut any tree in terms of the provisions of the aforementioned Act. The Employer has assessed the number of trees existing within the right-of-way and has arranged for cutting and removal of trees, which are likely to be affected by the right of way (i.e., within the limits of permanent works) construction works. The trees requiring to be felled will have to be removed from ground level prior to commencement of the works. The Contractor have to cut and remove the trees as directed by the Employer.

7.2 The Contractor shall carefully survey the site and identify the additional trees, if any which are coming within the footprints of the permanent structure / building and within the space required for forming slopes / benching etc., for excavation of the basements and are required to be cut / trimmed. The Contractor must notify the Engineer of such requirements well in advance.

7.3 On receipt of the submission by the Contractor giving such details, the Engineer shall arrange to verify the requirement of tree cutting / removal and identify the trees, which can be transplanted subject to compliance with the aforementioned Act. These requirements and details will be forwarded to Forest Department for getting the permission. Contractor will lease with the Forest Department for getting the permission. The Contractor shall also submit a detailed procedure approved by the Engineer for such transplantation duly assisted by competent horticulturist. The trees have to be transplanted as directed by the Engineer. The Contractor has to obtain permission for tree cutting from the concerned authority and then only trees can be cut / transplanted. The Contractor has to arrange for tree felling / transplantation of the trees at the desired locations as suggested by the authorities.

8.0 REMOVAL OF GRAVES AND OTHER OBSTRUCTIONS

8.1 If any grave and other obstructions are required to be removed in order to execute the Works and such removal has not already been arranged for, the Contractor shall draw the Engineer's attention to them in good time to make necessary arrangement for authorizations for such removal. The Contractor shall not himself remove them unless the Engineer has given consent.

9.0 PROTECTION THE ADJACENT STRUCTURES AND WORKS

9.1 The Contractor shall be taking all necessary precautions to protect the structures or works being carried out by others adjacent to and, for the time being, within the Site from the effects of vibrations, undermining and any other earth movements or the diversion of water flow arising from its works

10.0 SITE ESTABLISHMENT- DELETED

11.0 Submissions of Particulars - DELETED

12.0 Security - DELETED

13.0 Records of Wage Rates-

13.1 The Contractor shall keep monthly records of the average, high and low wage rates for each trade/ tradesman employed on the Site and records shall be made available to the Engineer during inspection. Contractor has to follow all the existing labor laws.

14.0 Provision and Disposal of Earthworks / Materials

14.1 The Contractor shall be responsible for the provision of all classes of earthworks material required for the Works, whether sourced from the excavation within the Contractor obtained from any other source located outside the Site, for which the Engineer has given the concerned. For fill or dumping sites, the Contractor shall prepare a land plan with the details of surface drainage requirement, final formation levels and arrangement for spreading and comparison of the filled during dumping as acceptable to the Engineer, at contractors dumping yard. The contractor shall also provide security for the Site. The dumping site to be used by the Contractor shall be as directed by the Engineer, and has to be arranged by the contractor at his own cost.

14.2 All excavated material, including waste material shall be disposed of at the contractor dumping yard only. The useful material shall be placed and compacted in accordance with the Construction specification for Earth Works or as otherwise directed by the Engineer 's Representatives. The disposal of waste material, bentonite fluid and material contaminated with bentonite shall be the full responsibility of the Contractor and these materials shall be disposed of by the Contractor at his dumping yard and in an approved manner.

14.3 Rock / Dismantled Concrete deposited as fill material at contractors dumping yard.

15.0 Restoration of Areas Disturbed by Construction

Unless otherwise directed by the Engineer, any area disturbed by the construction activity, either inside or outside the Project Right of Way, shall be reinstated as follows:

All areas affected by the construction work shall be reinstated to their original condition, with new materials, including but not necessarily limited to, sidewalks, parking lots, access roads, adjacent roads, properties and landscaping. Grass cover shall be provided for any bare earth surface areas, along with proper provisions for surface drainage.

16.0 Contractor's Labour Camps

16.1 The Employer will not provide living accommodation for use of the Contractor or any of his staff or labour employed on the works. Living accommodation shall not be established on any land provided to the Contractor by the Employer for the Works.

16.2 Provision of Labour Camps

The Contractor, shall, at his own expense, make adequate arrangements for the housing, supply of drinking water and provision of bathrooms, latrines and urinals, with adequate water supply, for his staff as well as for workmen employed on the Works directly or through sub-contractors at the location authorized by Engineer. No labour camp shall be allowed at work site or any unauthorized place.

The Contractor at his own cost shall maintain all campsites in a clean and sanitary condition. The Contractor shall obey all health and sanitary rules and regulations, and carry out at his cost all health and sanitary measures that may from time to time be prescribed by the Local/Medical Authorities and permit inspection of all health and sanitary arrangements at all times by the Employer, the Engineer and the staff of the local municipality or other authorities concerned.

-0-0-0-

SECTION – 1

GENERAL

Sl. No.	Section No.	Description	Page No.
1	SECTION- 01	GENERAL	266
2	SECTION-02	Compact Sub-Station 500,800KVA	275
3	SECTION -03	DAS Specified Ring Main Unit	304
4	SECTION -04	COMPACT Ring Main Unit	342
5	SECTION -05	H.T 11 K.V UNDER GROUND CABLE.	354
6	SECTION -06	L.T 1.1 K.V UNDER GROUND CABLE.	370
7	SECTION -07	ABC CABLE (L.T)	382
8	SECTION -08	ALUMINIUM LEAD WIRE (PVC INSULATED)	424
9	SECTION -09	JOINT & TERMINATION KITS	429
10	SECTION- 10	FEEDER PILLAR BOX	442
11	SECTION- 11	SPUN POLE	449
12	SECTION- 12	PSCC POLE	459
13	SECTION- 13	EARTHING ARRANGEMENT	468
14	SECTION- 14	LED STREET LIGHT	472
15	SECTION-I5	MISCELLANEOUS	477
16	SECTION-I6	CONCRETE	479

1.GENERAL

1.1 General

- 1.1.1** These Specifications contained herein shall be read in conjunction with other tender documents.
- 1.1.2** The Work shall be carried out in accordance with the approved drawings and designs as would be submitted by the contractor and approved by the Engineer duly signed and stamped or issued to the Contractor by the Engineer duly signed and stamped by him as the case may be. The Contractor shall not take cognisance of any drawings, designs, specifications, etc. not bearing Engineer's signature and stamp. Similarly, the Contractor shall not take cognisance of instructions given by any other Authority except the instructions given by the Engineer in writing.
- 1.1.3** The work shall be executed and measured as per metric units given in the Schedule of Quantities, drawings etc. (FPS units where indicated are for guidance only).
- 1.1.4** Absence of terms such as providing, supplying, laying, installing, fixing etc. in the descriptions does not even remotely suggest that the Contractor is absolved of such providing, supplying etc. unless an explicit stipulation is made in this contract.
- 1.1.5** The specifications have been divided into different sections / sub-heads for convenience only. They do not restrict any cross-references. The Contractor shall take into account inter-relations between various parts of works/trades. No claim shall be entertained on the basis of compartmental interpretations.
- 1.1.6** The classification of various items of works for purposes of measurements and payments shall be as per Bills of Quantities (BOQ). Except where distinguished by BOQ, the rates apply to all heights, depths, leads, lifts, sizes, shapes and locations. They also cater for all cuts and wastes.
- 1.1.7** Reference to the Standard Codes of Practice.
1. The contractor shall make available at site all relevant Codes of practice as applicable.
 2. Legend:

BS	British Standard
CPWD	Central Public Works Department
IRS	Indian Railway Standards
IS	Indian Standards

1.1.8 Other Publications: - DELETED

1.1.9 Contractor to Provide:

The Contractor shall provide and maintain at site throughout the period of works the following at his own cost and without extra charge, except for the items specified in the Bill of Quantities the cost being held to be included in the Contract Rates:

1. General works such as site clearance before and on completion of works.
2. All labour, materials, plant, equipment and temporary works, overhead charges as well as general liabilities, obligations, insurance and risks arising out of GCC, required completing and maintaining the works to the satisfaction of the Engineer.
3. Adequate lighting for night works, and also at other times whenever and wherever required by the Engineer.
4. Temporary fences, barricades, guards, lights and protective work necessary for protection of workmen, supervisors, engineers, General public and any other persons permitted access to the site. Contractor shall provide proper signages as directed.

All fences, barricade shall be painted with colour shades as specified by the Engineer. The barricading should be of adequate height to ensure visual obstruction of work from public view.

5. All equipment, instruments, labour and materials required by the Engineer for satisfactory completion of works.
6. Design mixes and testing them as per relevant clauses of specifications giving proportion of ingredients, sources of aggregates and binder along with accompanying trial mixes. Test results to be submitted to the Engineer for his approval before adoption on works.
7. Cost of Preparation and compliance with provision of a quality assurance control program.
8. Cost of safe guarding the environment as per SCC.
9. Contractor has to provide Method statements ie detailed work procedure for all the works

1.1.10 Quality Assurance & Quality Control

1. The work shall conform to high standards of design and workmanship, shall be structurally sound and aesthetically pleasing. The Contractor shall conform to the Quality standards prescribed, which shall form the backbone for the Quality Assurance and Quality Control system.
2. At the site, the Contractor shall arrange the materials, their stacking/storage in as per the standards manner to ensure the quality. The Contractor shall provide all the necessary equipment and qualified manpower to test the quality of materials, assemblies etc., as directed by the Engineer. The tests shall be conducted at specified intervals and the results of tests properly documented. The cost of all such testing shall be included in the quoted rates and nothing extra shall be paid for in this regard. In addition, the Contractor shall keep appropriate tools and equipment for checking alignments, levels, slopes and evenness of the surfaces.
3. (a) The Engineer shall be free to carry out such tests as may be decided by him at his sole discretion, from time to time, in addition to those specified in this document as per provisions of General Conditions of Contract. The Contractor shall provide the samples and labour for collecting the samples. Nothing extra shall be payable to the Contractor for samples, or for the collection of the samples.

(b) The test shall be conducted at the Site laboratory that may (to) be established by the Contractor at his cost or at any other Standard Laboratory selected by the Engineer.

(c) The Contractor shall transport the samples to the laboratory for which nothing extra shall be payable. In the event of the Contractor failing to arrange transportation of the samples in proper time the Engineer shall have them transported and recover two times the actual cost from the Contractor's bills.

(d) All testing shall be performed in the presence of Engineer or his authorised representative. Testing may be witnessed by the Contractor or his authorised representative if permitted by the Test House. Whether witnessed by the Contractor or not, the test results shall be binding on the Contractor.
4. All materials which do not conform to these specifications shall be rejected. In the event of contractor not being able to arrange the material conforming to these specifications or in the event of failure of the contractor to get the sources approved within the agreed schedule submitted by contractor, the Engineer shall have the powers to cause the Contractors to purchase and use such materials from any particular source, as may, in the Engineer's opinion, be necessary for the proper execution of work.

1.1.11 Dimensions

1. Figured dimensions on drawings shall only be followed and drawings to a large scale shall take precedence over those to a smaller scale. Special dimensions or directions in the specifications shall supersede all others. All dimensions shall be checked on site prior to execution.
2. The size, measurements and other information concerning the existing site as shown on the drawings are believed to be correct, but the Contractor should verify them for himself and also examine the nature of the ground as no claim or allowance whatsoever will be entertained on account of any errors or omissions in the levels or the description of the ground levels or strata turning out different from what was expected or shown on the drawings.

1.1.12 Setting out of Works-DELETED

1.1.13 Materials

1. Source of Materials

It shall be the responsibility of the contractor to procure all the materials required for construction and completion of the contract. The contractor shall indicate in writing the source of materials well in advance to the Engineer, after the award of the work and get it approved from the Engineer before commencing the work. If the material from any source is found to be unacceptable at any time, it shall be rejected by the Engineer.

2. Quality

All materials used in the works shall be of the best quality of their respective kinds as specified herein, obtained from sources and suppliers approved by the Engineer and shall comply strictly with the tests prescribed hereafter, or where tests are not laid down in the specifications, with the requirements of the latest issues of the relevant Indian & other Standards.

3. Sampling and Testing

All materials used in the works shall be subjected to inspection and test in addition to test certificates. Samples of all materials proposed to be employed in the permanent works shall be submitted to the Engineer at least 15 days in advance for approval before they are brought to the site.

Samples required for approval and testing must be supplied sufficiently in advance in required quantity and number to allow for testing and approval, due allowance being

made for the fact that if the first samples are rejected further samples may be required. Delay to the works arising from the late submission of samples will not be acceptable as a reason for delay in completion of the works.

Materials shall be tested before leaving the manufacturer's premises, source. Materials shall also be tested at site and they may be rejected if not found suitable or in accordance with the specifications, notwithstanding the results of the tests at the manufacturer's works or elsewhere or test certificates or any approval given earlier.

The contractor will bear all expenses for sampling and testing, whether at the manufacturer's premises at source, at site or at any testing laboratory or institution as directed by the Engineer subject to the provisions of No extra payment shall be made on this account.

4. Dispatch of materials

Materials shall not be dispatched from the manufacturer's works to the site without written authority from the Engineer.

5. Test certificates

All manufacturer's certificates of test, proof sheets, etc showing that the materials have been tested in accordance with the requirement of these specifications and of the appropriate Indian Standards are to be supplied free of charge to the Engineer.

6. Rejection

Any materials that have not been found to conform to the specifications or otherwise not acceptable to the Engineer will be rejected forthwith and shall be removed from the site by the Contractor at his own cost within three days or as instructed by the Engineer.

1.1.14 Storing of Materials at site

All materials used in the works shall be stored on racks, supports, in bins, silos, go-downs, under cover etc. as appropriate to prevent deterioration or damage from any cause whatsoever to the entire satisfaction of the Engineer.

The storage of materials shall be in accordance with IS 4082 "Recommendation on stacking and storage of construction materials on site" and as per IS 7969 "Safety code for handling and storage of building materials".

The materials shall be stored in a proper manner at places at site approved by the Engineer. Should the place, where material is stored by the Contractor, be required by the Employer for

any other purpose, the Contractor shall forthwith remove the material from that place at his own cost and clear the place for the use of the Employer within the time as communicated by the Engineer and at no extra cost to the Employer.

1.1.15 Water

1. Water from approved source:

Potable water only shall be used for the works. Contractor shall have his own source of water duly tested and approved by Engineer. The water shall be free from any deleterious matter in solution or in suspension and be obtained from an approved source. The quality of water shall conform to IS 456.

2. Storage:

The Contractor shall make his own arrangements for storing water, if necessary, in drums or tanks or cisterns, to the approval of the Engineer. Care shall be exercised to see that water is not contaminated in any way.

3. Testing:

Before starting any concreting work and wherever the source of water changes, the water shall be tested for its chemical and other impurities to ascertain its suitability for use in concrete for approval of the Engineer. No water shall be used until tested and found satisfactory. Cost of all such Tests shall be borne by the contractor.

1.1.16 Workmanship

1. Any work not to the satisfaction of the Engineer or his representative will be rejected and the same shall be rectified, or removed and replaced with work of the required standard of workmanship at no extra cost.

1.1.17 Load Testing On Completed Structures -DELETED

1.2 STRUCTURAL WORK-DELETED

1.2.1 Supply of Monthly Progress Photographs and Album-DELETED

1.2.2 Supply of Monthly Progress Video CD's-DELETED

1.2.3 Survey Work-DELETED

1.2.4 Barricading

The work covers barricading for the work done along the Existing IR track, median and areas affecting road or rail traffic. Barricading for other areas like casting yard, batching plant,

storage and other working area shall be done at own cost by the contractor. The detailed scope of work is:

- (i) Providing and installing the barricade of the design and type as shown in the typical sketch furnished as per the approved plan firmly to the ground and maintaining it during the progress of work.
- (ii) Providing adequate road and IR track safety devices. A tentative list given hereunder identifies minimum items, which may be required. However, actual numbers required shall be as per plan approved by the Engineer and clearance obtained from traffic department, Bangalore and concerned division of Railway officials. During execution of works, if any additional cost to this list is required then the contractor shall not be paid any extra cost.
- (iii) Dismantling of barricade, other temporary installation from the site and cleaning the site shall be as per direction of Engineer upon completion and acceptance of work.

Tentative Road or IR track Safety Devices are mentioned below or any other safety devices as per site requirement

1. Supply of Red portable traffic cones of 750mm height with white reflective tape bands on 100mm width all around.
2. Hazard warning light flashes with rechargeable. Maintenance free battery & charging system.
3. Safety light island post with 11 nos. parallel reflective.
4. Red reflective arrow fitted on enabled mild steel board of 360 x 220mm size.
5. Traffic Triangular Tripod made of fluorescent cloth fitted on steel frame.
6. Retro-reflective tape (I) 50mm width.
7. Fluorescent Jackets with reflective tape all around.
8. Yellow reflective cat eyes of size 115 x 11 x 22 mm made of ABS material having 19 glass beads on each side.
9. Metal Tabular Delineator of 610mm height with reflective tapes.
10. Retro-reflective arrows diversion board 450 x 900mm with crystal clear protective transparent coat to avoid damage on 14-gauge Mild Steel sheet with and without pole.
11. Retro-reflective "Men at Work" triangular board of size 900mm with crystal protective transparent coat to avoid damage on 14-gauge Mild Steel board with and without poles.
12. Retro-reflective board for "Go Slow Work in Progress" of size 1200 x 750mm with crystal clear protective transparent coat to avoid damage to the Mild Steel board with and without pole.
13. Retro-reflective advance direction signs cum Diversion Boards of size 1200 x 900mm with crystal clear protective transparent coat to avoid damage to the 14 gauge Mild Steel sheet with and without pole.

14. Retro-reflective speed limit circular sign Boards of 600mm Diameter with crystal clear protective transparent coat to avoid damage on 14 gauge sheet (without pole).
15. 'SORRY FOR INCONVENIENCE' Retro-reflective Boards of size 900 x 300mm size with crystal clear protective transparent coat to avoid damage on 14 gauge Mild Steel sheet (without pole).
16. HAZARD MARKERS (Yellow & Black) must be put all over the construction sites. This Retro-reflective board is of size 300 x 900mm with crystal clear protective coat to avoid damage and the 14 gauge Mild Steel with or without pole.
17. 'CAUTION' tape which is normally yellow tape of special Polyether Material having 75mm width 'CAUTION' is written all over with Black colour is rolls of 300 meter.
18. For running trains, Retro-reflective speed limit as per IR Specifications.

1.2.4.1 Measurement-DELETED

1.2.5 Transplantation of Trees -DELETED

1.2.5.1 Measurement-DELETED

Sub-Contractor-DELETED

1.3 Guarantees and Maintenance: - DELETED

1.3.1 Responsibility for Shop drawings, Samples and Mock-ups: - DELETED

1.3.2 Cleaning - DELETED

1.3.3 Expansion bolts/ fasteners: -DELETED

1.4 Applicable Codes, Standards & Publications for Electrical works

The important Codes, Standards and Publications to Contract are listed here under:

Sl.no	Standard	Description
1	IS:3427	AC metal enclosed switchgear and control gear for rated voltages above 1 KV and up to and including 52 KV.
2	IS 12063	Classification of degrees of protection provided by enclosures of electrical equipment
3	IS 9920 (Parts 1 to 4):	High Voltage Switches.
4	IS 9921 (Parts 1 to 5):	Specification for AC disconnectors and earthing switches for voltages above 1000 V
5	IS 13118	HV AC Circuit Breakers

6	IS 12729	General requirements of switchgear and control gear for voltages exceeding 1000 V
7	IS 10601	Dimensions of terminals of HV Switchgear and Control gear.
8	IEC 1330	High voltage/Low voltage prefabricated substations
9	IEC 60694	Common clauses for MV switchgear standards.
10	IEC 6081	Monitoring and control.
11	IS 2705	Current Transformers
12	IS 3156	Voltage transformers
13	IS 8686	Specification for Static Protective Relays
14	IEC 62271-200	Standards for high voltage metal clad switchgear up to 52 KV.
15	IS 8130	Conductors for insulated electrical cables and flexible cords.
16	IS 10810(series)	Methods of tests for cables.
17	IS 10418	Drums for electric cables.
18	IS 7098 (Part 2)	Cross-linked Polyethylene insulation for Cables
19	IS 5831	Specification for PVC insulation sheath for electric cables
20	IS 7098 (Part-II) 13573,1992	Power cables with extruded insulation and their accessories for rated voltages from 1 kV ($U_m = 1,2$ kV) up to 30 kV ($U_m = 36$ kV) - ALL PARTS
21	IS 3043	Code of Practice for Earthing
22	IS 398-part II	Aluminium Conductor for Overhead Transmission Purpose
23	IEC-99-4	Gapless Lightning Arrestor
24	IS 3070 P-III	Metal Oxide Surge Arrestors without gaps for AC Systems
25	IEC 99 P-III	Artificial Pollution Testing of Lightning Arrestor
26	IS 2071	Methods of H V Testing
27	IS 694	PVC Insulated cables for working voltages up to and including 1000V
28	IS 14786/2000	Specification for high voltage pre-fabricated Sub-station
29	IS 1180	Power Transformer
30	IS 3637	Gas Operated relays
31	IS 1347	Low Voltage Switchgear and Control gear
32	IS 1255	Code of practice for installation and maintenance of power cables up to and including 33 kv rating
33	IS 13158	Prestressed concrete circular spun poles for overhead power, traction and telecommunication lines -- specification
34	IS 785	Reinforced concrete poles for overhead power and telecommunication lines - specification
35	IS 4091	Code of practice for design and construction of foundations for transmission line, tower and poles

SECTION – 2

**OUTDOOR TYPE PACKAGED SUBSTATION
(COMPACT SUBSTATION)**

**TECHNICAL SPECIFICATION FOR 11 / 0.433KV HIGH VOLTAGE /LOW VOLTAGE
COMPACT PRE-FABRICATED PACKAGED SUBSTATION****1 SCOPE**

The specification covers design, manufacture, Testing, Inspection, Packing, Transportation and supply of 11/0.433 kV Packaged Substation with all safety accessories, tools and tackles. The substation shall be designed, manufactured and tested as per IEC 62271. The substation shall be tested for internal arc test.

Test methods of pre-fabricated sub-station which are cable connected to be operated from inside or outside for alternating current of primary rated voltage 10KV to 13KV and for a transformer of maximum power 1000KVA for service frequencies. The Pre-Fabricated sub-station can be situated at ground level are partially or completely below ground level.

2 SYSTEM DETAILS

KPTCL Power is fed to Grid Substations at 66 / 11 KV from the 220 / 66 and where it is stepped down to the primary distribution voltage of 11kV. BESCO distribute the power at 11 KV to consumers.

3 A. BILL OF QUANTITY

Each offer of Packaged Substations shall consist of

- | | | | |
|----|---|-----|-------|
| a. | 11 KV 3-way RMU Unit (SF6/VCB type) | --- | 1 no. |
| b. | 11 / 0.433 KV, Distribution transformer | --- | 1 no |
| c. | Bus bar connection between LT terminal
of transformer to ACB and to MCCB | --- | 1 set |
| d. | Enclosure for entire sub station | | |
| e. | Exhaust fan for Transformer Compartment | | |
| f. | Provision for ETV Meter with CT & wiring | | |
| g. | MCCB/ACB details: | | |

Sl. No	Transformer	No. of MCCB	Capacity of MCCB 4 pole 50KA, TM Based	Incomer for LT
1	100kVA Al. Winding	2	100A	250A MCCB, 50kA, 4 pole Fixed Type Micro Processor based
2	250kVA Al. Winding	3	250A	400A MCCB, 50kA, 4 pole Fixed Type Micro Processor based
3	500kVA Al. Winding	7	250A	800A ACB, 50kA, 4 pole Fixed Type Micro Processor based
4	800kVA Cu winding	6	250A	1250A ACB, 50kA Fixed Type 4 pole Micro Processor based
5	1000kVA Cu winding	7	3 x 400A 4 x 250A	1600A ACB, 50kA Fixed Type 4 pole Micro Processor based

B. SPARE

The bidder has to specify the list of recommended spare per packaged substation for a period of 2 years.

4 SITE CONDITION

The equipment covered under this specification is for **outdoor installation** and should be suitable for use at the sites in BESCO jurisdiction for the prevailing climatic conditions.

a) TEMPERATURE: The reference ambient temperature is to be taken as 43.3°C as per IS 9676.

- i) Maximum ambient air temp----- 50°C
- ii) Maximum daily average ambient temp----- 40°C

b) RELATIVE HUMIDITY

- i) Maximum ----- 100%
- ii) Minimum ----- 10%

c) Average Annual rainfall ----- 750mm

d) Average no of rainy days/annum----- 50

e) Average no of thunderstorm days/annum----- 40

f) Altitude ----- Not exceeding 300 m

g) Rainy months ----- June to Oct

h) Wind pressure ----- 195kg/m² up to 30m elevation as per IS 875/75.

The atmosphere is heavily polluted, laden with mild acid and dust in suspension during the dry months and is subjected to fog in cold months. Heavy lightening occurs in the area during rainy months.

All equipment's shall be designed to withstand seismic forces, corresponding to an acceleration of 0.1g.

5 DRAWINGS AND DOCUMENTS

Vendor shall furnish with the detail, as per "VENDOR DATA REQUIREMENT", attached with the specification.

6 INSTRUCTIONS TO BIDDERS

6.1 All equipment and material shall be designed manufactured and tested in accordance with the latest applicable Indian Standard, IEC standard and CBIP manuals.

6.2 The electrical installation shall meet the requirement of Indian Electricity Rules as amended up to date relevant IS code of practice and Indian electricity act. In addition, other rules of regulations applicable to the work shall be followed.

6.3 The high-tension Switchgear, distribution transformer, LT Switchgear & its accessories offered shall in general comply to the following specification attached.

- A. Specification for 11kV Non extensible compact RMU
- B. Specification for Distribution Transformer
- C. Specification for LT system
- D. Specification for enclosure for package substation.

A. SPECIFICATION FOR 11 kV Non-Extensible Compact RMU

1 CODES AND STANDARDS

1.1 The equipment shall comply with the requirements of latest revision of following standards issued by BIS (Bureau of Indian Standards), unless otherwise specified.

IS 694:	PVC insulated cables for working voltages up to and including 1100V.
IS 722:	Integrating meters.
IS 1248:	Electrical indicating instruments.
IS 2071:	Methods of high voltage testing.
IS 2544:	Porcelain post insulators for systems with nominal voltage greater than 1000V.
IS 2705:	Current Transformer.
IS 3156:	Voltage Transformer.
IS 3231:	Electrical relays for power system protection.
IS 3427:	Metal enclosed Switchgear and Control gear for voltages above 1000V but not exceeding 11000V.
IS 3618:	Phosphate treatment of iron and steel for protection against corrosion.
IS 5082:	Material for data for aluminum bus bars.
IS 5578:	Guide for marking of insulated conductors.
IS 6005:	Code of practice of phosphating of iron and steel.
IS 9046:	AC conductors of voltage above 1000V up to and including 11000V.
IS 9920:	Switches and Switch isolators for voltages above 1000V.
IEC: 1330:	Specification for High Voltage Pre-Fabricated Sub-Station.
1995 IS: 14786/2000	International Electro Technical
IEC:50 (441):1984	Vocabulary (IEU) chapter 441 Switch gear, Control gear & fuses.
IS:1885 (Part 17)	AC metal enclosed Switch gear and Control gear for rated voltages above 1 KV and up to and including 52KV.
IEC: 298:1990:IS: 3427	Electrical installation of building.
IEC: 364-4-441: 1992	protection for safety, chapter 41 protection against electrical shock.
Part 4	Low voltage Switch gear and Control gear assemblies Part-I, type tested and partially type tested assemblies.
IEC:439-1:1992:IS:8623	AC Insulator-enclosed Switch gear and Control gear for rated voltages above 1 KV and up to and including 38KV.
(Part I)	Degree of protection provided by enclosures (IP code).
IEC: 466:1987:	Insulators co-ordination for equipment's with low voltage system Part-I, principles and tests.
IS:14659	Common clauses for high voltage Switch gear and Control gear standards.
IEC: 529:1989:	Low voltage Switch gear and Control gear Part-I, general rules.
IS:12063	
IEC:664-1,1992:	
IEC:694,1980:	
IEC:947-1,1988	
IS:13947 (Part I)	

IEC:1180-1,1992	High voltage test Techniques for low voltage equipment Part – I, definition test and procedure requirement.
ISO: 1052:1982	Steels for general engineering purposes.
ISO: 1210:1992	Plastics determination of the burning behavior of horizontal and electrical Specimen in contact with small flame or ignition source.
IEC:694:IS:12729	Common clauses for high voltage Switch gear and Control gear standards.
IEC:298:IS:3427	AC metal enclosed Switch gear and Control gear for rated voltage above 1 KV and up to and including 52KV.
IEC:129	AC Switches and Earthing Switches.
IEC:265:IS:9920	Switches and dis-connectors (All parts)
IEC:801	Monitoring and Control.
IS:13118	High voltage AC circuit breakers.
IS/BS:5463	High voltage Switches.
IS/BS:5227	Metal enclosed AC Switch gear.
IEC:376	For SF6 Gas used for the filling of RMU.
IS 9921:	AC dis-connectors (isolators) and earthing Switches for voltage above 1000V.
IS 11353:	Guide for uniform system of marking and identification of conductors and apparatus terminals.
IS 12661:	HV motor starters.
IS 12729:	General requirements for Switchgear and Control gear for voltages exceeding 1000V.
IS 13118:	General requirements for circuit breakers for voltages above 1000V.
IS 13703:	Low voltage fuses.

- 1.2 In case of imported equipment standards of the country of origin shall be applicable if these standards are equivalent or stringent than the applicable Indian standards.
- 1.3 The equipment shall also conform to the provisions of Indian electricity rules and other statutory regulations currently in force in the country.

2 Design Criteria

- 2.1 The 11KV Non-Extensible, Non-metering Switchgear shall be installed at Outdoor substation location along the ring main 11KV feeder system in BESCO supply area. 11KV wing isolator Controls incoming/Outgoing feeder cables of the 11KV distribution system. Tee-off Vacuum/ SF6 Circuit Breaker shall be used to Control and isolate the 11KV/433V distribution transformer / HT Consumers connected through 11KV grade underground cable at distribution center.
- 2.2 The Switchgear and component thereof shall be capable of withstanding the mechanical and thermal stresses of short circuit listed in ratings and requirements clause without any damage or deterioration of the materials.
- 2.3 For continuous operation at specified ratings temperature rise of the various Switchgear components shall be limited to permissible values stipulated in the relevant standard and / or this specification.

- 2.4 The equipment offered shall be suitable for continuous satisfactory operation as per site condition specified elsewhere.

3 Specific Requirement

- 3.1 The requirement of 11KV, 20 KA SF6/VCB insulated Non-Extensible SF6 insulated Ring Main Unit is as under.

- a) Non-Extensible compact ring main unit suitable for Indoor/Outdoor installation shall consist of the following.
- i. Two numbers of 11KV, **630 Amps**, continuously rated fault making, load breaking Switches. These units shall be triple pole, SF6 Insulated, quick break type with spring charge stored energy mechanism for operation. It shall have arrangement for terminating up to 400sq.mm incoming and outgoing 11KV, 3C XLPE HT UG cables.
 - ii. One Tee-Off unit with 11kV, **200 Amps** Vacuum / SF6 Circuit Beaker (for Controlling transformer), load breaking and fault breaking type fitted with three 200 Amps continuously rated SF6 insulated busbar along with CT with combination for protection of transformer. It shall have arrangement for terminating up to 240sqmm 11KV, 3C XLPE HT UG cables.
 - iii. Providing **Right angled reusable boot** for terminations (3x3 nos.)

3.2 System:

- 3.2.1 The system network is 11000 Volts, 3 phase 3 wires 50 cycles with neutral solidly grounded. The voltage and frequency are subject to variation as per statutory limits governed by Indian Electricity Rules 1956 with latest amendments in force.

a. GENERAL FINISH:

The equipment should be totally enclosed, metal clad, vermin and dust proof suitable for tropical climate use as detailed above. The body of the RMU Unit should be of **metalized cast resin tank /stainless steel** and should be **rust free**.

b. PAINTING:

The surface of all metallic parts shall be thoroughly cleaned, scrapped and degreased preferably by shot blasting or any other treatment. The exterior surface shall be given two coats of rust resisting red oxide primer conforming to IS 2074:1992 and final two coats of weather resisting battleship grey enamel paint. The paint shall withstand the operating conditions described above and equipment shall not show any sign of the rust formation.

c. RATING:

The busbar shall have continuous rating of **630 Amps**. The isolator should have continuous rating of 630 Amps and Vacuum / SF6 circuit breaker shall have a continuous rating of 200 Amps.

All connection including band joints for busbars etc., shall be of ample cross section to cater the rated load current continuously and shall be suitable for short time rating of **20 KA for 3 seconds**.

4 Breaking and Making CAPACITY:

- i. The Vacuum / SF6 circuit breaker shall be capable of having rupturing capacity of **350 MVA** symmetrical at 11000 Volts three phase. Symmetrical breaking capacity shall be **20 KA** and the making capacity of **50 KA** at 11000 Volts. The isolators shall be capable for breaking rated full load current and shall have fault making capacity of **50 KA peak**.

4.1 Type of EQUIPMENT:

4.1.1 The equipment shall be compact, totally enclosed in as self-contained self-supporting, gas tight compartment, mounted on base frame or channels. The assembly shall be equipped with common power busbars, load break Switches and SF6/vacuum circuit breaker as specified in specific requirement as above. All medium voltage parts should be totally enclosed in an SF6 environment.

4.1.2 **BUSBARS:** The busbar shall be SF6 insulated type. The cross-sectional area of the copper busbar and jointing accessories shall be furnished prior to supply of item.

(a) Isolator:

The isolators offered shall conform to IEC-265 IS-9920 (all parts) as amended to date. The isolator shall be SF6 insulated, triple pole, spring assisted hand operated type with quick break contacts. The isolator shall be contained in sealed SF6 enclosure made of stainless steel. SF6 gas pressure gauge shall be provided for pressure indication purpose.

- a) The operating handle shall have the three positions "ON", "OFF", and "EARTH" which shall be clearly marked with suitable arrangement to padlock in any position. A safety arrangement for locking shall be provided by which the isolator operation shall be prevented from "ON" position to "EARTH" position or vice versa in a single operation.
- b) Integral cable test terminals for test plug with clear identification mark and with interlocked cover shall be provided. The interlocks shall be so arranged that, the cable test terminals will be accessible only in the "EARTH" position of the isolator.
- c) To facilitate testing of cables, it shall be possible to bring the isolator to OFF position while the test plugs are kept inserted, but operation to ON position shall be prevented so long the cable testing is in progress.
- d) The isolator shall be capable of breaking full load current and a fault making of 50 KA peak.
- e) Isolators: Isolators are to be operated manually.

(b) Vacuum / SF6 Circuit Breaker

- The tee-off unit shall consist of 11KV, **200 Amps** VCB/ SF6 (for Controlling transformer), load breaking and fault breaking type fitted with three 200 Amps continuously rated SF6 gas insulated busbars and arrangement for cable to the primary side of the transformer.
- The Tee-off circuit breaker shall be suitable for manual closing and opening.
- The operating mechanism shall be direct hand operated trip free with a mechanically operated indicator, positively coupled to the operating mechanism to indicate whether the breaker is in the closed or in the open position.
- Off load isolator shall have three positions i.e., ON, OFF & EARTH.
- Voltage Indication: There should be arrangement to check whether the cable connecting to the isolator is live or not.
- The tee-off unit shall be provided with accessories for tripping such as CT operated series trip coils for over current and earth fault protection.
- Breaker shall be provided with a **shunt trip** coil suitable for **230VAC** supply.
- Current Transformer: The Ratio of the CTs shall be suitable for Controlling transformer. The VA burden of the CTs shall be sufficient to supply the energy required by the relay for normal operation and tripping of the circuit breaker.
- Protection System: The protection system should be provided with the provision of suitable self-powered relays having scheme for both over current & earth fault. It must provide immediate protection and can detect faults instructing the circuit breaker to trip in less than 40 ms.
 - i. The protection system is a **self-powered relay which requires no external power source or batteries**.
 - ii. It must have improved operation and Control with the Relay settings clearly displayed on the front of the panel.
 - iii. It should have the provision for the trip test on circuit breaker. The 'trip inhibit' facility allows the Relay to be tested without tripping the circuit breaker. Secondary injection can also be carried out using conventional test equipment's.

The free-standing metal housing shall be designed to withstand internal pressure and external mechanical loads without distortion. Where required the SF6 gas insulated Switchgear housing shall have an over pressure relief device vented to the rear side of the equipment. An operating mimic diagram shall be provided on the front side of RMU. Each unit shall be provided with lifting facility of proven design for easy handling.

Isolator / Breaker ON-OFF, Earth, (230VAC space heater, thermostat Controlled) with heater ON/OFF indication & 'SF6 gas pressure low' indication etc. shall be provided.

Handle operated 'spring charged' mechanical operation shall be provided.

Local Control of Switch / isolator shall be possible.

Local operation selector Switch shall be provided.

SF6 Insulation: Switchgear housing shall be completely gas tight. In the power compartment, provision shall be made for filling up the gas at site.

A manometer should be provided to indicate the healthy state of SF6 gas pressure inside the tank. SF6 gas pressure inside the tank shall not be more than 1 bar at 20 Deg Centigrade.

5 Operation and interlocking:

- 5.1 All operations shall be from front of the equipment via spring assisted mechanism. The Ring Main Unit and SF6/VCB for Tee-off should be provided with a series trip coil for tripping. It shall be possible to operate the Switches and circuit breaker manually and spring assisted mechanism shall ensure speed of operation of Switches.
- 5.2 Operation handle shall be considered as part of the unit and should be provided with each RMU.
- 5.3 Load break Switches and earthing Switches shall be fully interlocked to ensure that operation is carried out in correct sequence. Movement of operating handle against interlock shall not by any means originate, store or activate the energy mechanisms. Padlocking facility shall be provided for operation of load Switch and earthing Switch. Safety of operation shall be ensured by interlocks.
- 5.4 Simultaneously closing of the main Switch and earth Switch. This interlock shall be integral part of the operating mechanism. Also separate operating shafts shall be provided for operation of earthing Switch and main Switch for the same purpose.
- 5.5 The fully interlocked integral test facilities are to be provided underneath the units, so that access to the test terminals is achieved only by removal of a cover.
- 5.6 The SF6 insulated isolators and SF6/VCB breaker operating mechanisms shall be totally enclosed and self-lubricating type. The manually operated handle shall be mounted in front of the isolators and so designed that the operation is complete by one movement without any undue strain on the operator.
- 5.7 All mechanical interlock shall be robust so as not to give any way during normal operation.
- 5.8 The tripping of breaker unit should be provided with push button.

6 Secondary wiring:

- 6.1 The secondary wiring supplied for the equipment shall consist of non-deteriorating fire proof superior grade stranded copper PVC wires suitably colored and fitted with numbered ferrules at both ends. The cross section of the wires shall be 4 mm² for CT and 2.5 mm² for others. Following color codes shall be used for wiring.

C.T.: Red, Yellow, Blue, Black,
D.C. Circuit: Grey, Earth: Green,
A.C. Circuit: Black.

- 6.2 Wiring shall be terminated with ring type ferrules with ferrule numbers marked at both ends of wiring. CT wiring shall be marked with additional distinct red tags on both ends. All secondary wiring shall be terminated by using reputed make terminal blocks.

7 Earthing arrangement:

- a) It shall be easily possible to test the cables including the Tee-off (in case of RMU) by a simple earthing arrangement. In case of breaker, the earthing shall be preferably accomplished through the circuit breaker and the tripping arrangements made inoperative if required.
 - b) Equipment earthing of copper strips of adequate size shall be provided.
 - c) A set of earthing and a set of three phase test bushings shall form an integral part of RMU and shall be all enclosed within an interlocked cover to prevent incorrect operation. The access of the test bushing shall be fully interlocked.
- 7.1 A mechanical 'ON/OFF' indicator shall be provided on SF6 insulated isolators and SF6/VCB breaker to indicate whether Switch is ON or OFF.
- 7.2 SF6 insulated Switches shall be fitted with correct sequence device having "ON/OFF" and re-set and test position and shall have provision for padlocking **operating handle**.

8 Cable Boxes

- 8.1 The isolators and SF6/VCB shall be provided with suitable and identical cable boxes for connection 3 core, 11KV XLPE cables of size up to 400 Sqmm approaching vertical from below. The cable boxes shall be so located at convenient height to facilitate easy cable jointing work.
- 8.2 The access for the isolator cable box shall be from side and the access for the Tee-Off SF6 / VCB cable box shall be from rear side and distanced of bottom level of wiping gland from ground shall be maintained at 310 mm (minimum).
- 8.3 The cable boxes shall be with detachable front cover for ease of termination & shall be interlocked with Switch position (i.e., when isolator is in Earth / OFF position).
- 8.4 The design of the cable box shall be such that any type of jointing methods such as heat shrinkable/push on type/cold shrinkable type terminations can be adopted.
- 8.5 Earthing: All ring main units shall have a special earth bar with a sectional area of not less than 100 sq.mm run along the whole of metal enclosed Switch structure, each end being connected to the main earthing system where metal cases are used on instruments these shall be connected to this bar by conductors of not less than 16 mm² section.
- 8.6 All foundation bolts, nuts and washers necessary for installation shall be supplied by the manufacturer.
- 8.7 Removable eye bolts shall be provided to facilitate the handling of the RMU/tee-off unit/ SF6 isolators.
- 8.8 Labels: All RMUs shall be clearly labeled as required indicating where necessary their purpose and "ON" and "OFF" lettered on brass, ivory, enamel iron or other suitable materials.
- 8.9 Name plate.

Each RMU and its associated equipment's shall be provided with a nameplate legible and indelibly marked with at least the following information.

- (a) Name of manufacturer
- (b) Type, design and serial number
- (c) Rated voltage and current
- (d) Rated frequency
- (e) Rated symmetrical breaking capacity
- (f) Rated making capacity
- (g) Rated short time current and its duration
- (h) Purchase Order number and date
- (i) Month and Year of supply
- (j) Rated lightning impulse withstand voltage
- (k) D.C. component of current.
- (l) DTs Structure name, 11000Volts Dangers etc.

NOTE:

- i) The word rated need not appear on the name plate. Recognized abbreviations may be used to express the above particulars.
- ii) Whether the circuit breaker is fitted with closing/tripping devices necessitating an auxiliary supply shall be stated either on the circuit breaker name plate or any other acceptable position.

9 Corona Discharge:

The equipment shall be so designed that corona discharge would occur under conditions mentioned earlier in this specification.

10 Ratings and Requirement

		Non-Metering SF6 Insulated Ring Main Unit with SF6/VCB Breaker
10.01	Switchgear Data	
a)	Service	Indoor
b)	Type	Metal clad
c)	Number of phases	3
d)	Voltage	11000V
e)	Rated Frequency	50 Hz
f)	Rated Current	630 Amps
g)	Short Circuit rating	
	Breaking Short time 3S	20 KA rms
h)	Insulation Level	75 KV peak
i)	System earthing	Solidly earthed at substation
10.02	Vacuum / SF6 Circuit Breaker	
a)	Type	SF6 / VCB encapsulated in SF6 Environment
b)	Rated Voltage	11kV
c)	Breaking Current	20 KA
d)	Making Current	50 KA peak
e)	Rupturing Capacity	350 MVA
f)	Rated Current	200 Amps
g)	No. of Poles	3

h)	Operating mechanism	Trip free & free handle type with mechanically operated indicator
10.03	Isolators	
a)	Type	SF6 insulated load breaking and fault making
b)	Duty cycle	-
c)	Rated current	630 Amps.
d)	Rated breaking capacity	630 Amps.
e)	Fault making capacity	50 kA peak
f)	Rupturing Capacity	350 MVA
g)	No. of poles	3
h)	Operating mechanism	Operating handle with ON, OFF, Earth positions with arrangement for padlocking in each position.
i)	SF6 tank	Tank with substantial stainless-steel construction with SF6 pressure Gauge for indicator and filling arrangement.
j)	Interlocks	Suitable interlocks for: 1. Cable test terminals on the orifices will be accessible only in "Earth" position. 2. Test plugs can be inserted and withdrawn only in the "Earth" position. 3. To prevent operation from "ON" position to "Earth" position or vice versa in a Single operation. 4. To bring isolator to "OFF" position with test plugs inserted but to prevent operation to "ON" position with test plugs inserted or test terminals kept open.
k)	Operation safety	Safety against explosion and fire hazards etc.
10.04	Busbars:	
a)	Material	Copper
b)	Type	SF6 insulated
c)	Rated Current	630 Amps
d)	Short time rating for 3 Sec.	20 kA
10.05	Cable Boxes	Vacuum / SF6 circuit breaker shall be provided with identical cable boxes for connecting 1 No. 11kV 3C, 70 to 300 mm ² XLPE/PILC cable
10.06	Current Transformer	
a)	C.T. Ratio	As per BESCO's requirement
b)	Over current factor	To correspond to rupturing capacity of Switchgear.
c)	Class of Accuracy	5 P 20
d)	Rated Burden	2.5 VA
10.07	Configuration	3 function RMU loop in /loop out and tee off CB
10.08	Protection	
	a) Three phase over current and earth fault relay.	Self-Powered Relay

11 TESTS

11.1 Each type of H.V. Switchgear shall be completely assembled, wired, adjusted and tested at the factory as per the relevant standards and during manufacture and on completion.

11.2 ROUTINE TEST

The tests shall be carried out in accordance with IEC 60298 include but not necessarily limited to the following:

- i. Withstand voltage at Power Frequency for all current carrying parts including wiring
- ii. Measurement of resistance of the main circuit
- iii. Gas Leakage test
- iv. Withstand voltage on auxiliary circuits
- v. Operation of functional locks, interlocks, signaling devices and auxiliary devices
- vi. Suitability and correct operation of protections, Control instruments and electrical connections of the circuit breaker operating mechanism (PRIMARY & SECONDARY INJECTION)
- vii. Verification of wiring
- viii. Visual Inspection

Routine test shall be carried out on all equipment such as circuit breakers, current transformers, relays, meter etc. as per relevant standards.

11.3 TYPE TEST

The following tests shall be performed on a typical section of the bus assembly of each type of Switchgear. Units shall be type tested in accordance with IEC Standards 60056, 60129, 60265, 60298, 60529 and 60694.

- a) Impulse test with breaker inside the cubicle
- b) Temperature rise test with breaker inside the cubicle
- c) Short Circuit test with breaker inside the breaker
- d) Dielectric Tests
- e) Test of apparatus i.e., circuit breaker and earthing Switch
- f) Arc Fault test

TEST WITNESS

All tests shall be performed in presence of owner's representatives, if so desired by the Owner. The Contractor shall give at least ten (10) days advance notice of the date when tests are to be carried out.

12 Test Certificates

- 12.1 Certified reports of all the tests carried out at the works shall be furnished in three (3) copies for approval of the Owner.
- 12.2 The equipment shall be dispatched from works only after receipt of Owner's written approval of the test reports.
- 12.3 Type test certificate on any equipment, if so desired by the Owner, shall be furnished; otherwise the equipment shall have to be type tested, free of charge, to prove the design.

13 DRAWING APPROVAL

The bidder has to take the approval for the various drawings of the RMU unit including the protection scheme. The bidder has to provide us all relay characteristics.

14 MANUAL

The bidder has to provide the complete manual for the operation of the breaker.

B. SPECIFICATION FOR DISTRIBUTION TRANSFORMER

The bidder has to quote for the following types of distribution transformers. The transformer should be of

- I. **Star 2 Rated, oil cooled, 11/0.433kV, 3Phase, 50Cycle, Distribution Transformer of rating 25/63/100/250/500 Aluminum Wound & 800/1000kVA copper wound.**

C. SPECIFICATION FOR LT SYSTEM

LT compartment shall be suitable to house following equipment, Bus bar connection from transformer to LT ACB & MCCB

SI.No	Transformer	No. of MCCB	Capacity of MCCB 4 pole 50KA, TM Based	Incomer for LT
1	100kVA Al. Winding	2	100A	250A MCCB, 50kA, 4 pole Fixed Type Micro Processor based
2	250kVA Al. Winding	3	250A	400A MCCB, 50kA, 4 pole Fixed Type Micro Processor based
3	500kVA Al. Winding	7	250A	800A ACB, 50kA, 4 pole Fixed Type Micro Processor based
4	800kVA Cu winding	6	250A	1250A ACB, 50kA Fixed Type 4 pole Micro Processor based
5	1000kVA Cu winding	7	3 x 400A 4 x 250A	1600A ACB, 50kA Fixed Type 4 pole Micro Processor based

Trivector meter (Provision- meter to be fixed by BESCOM)

CT for metering wiring for Trivector meter

CT for measuring the Current and voltage connection MFM

Cable glands for outgoing feeders

The design should comply for the following standards.

1. IEC-439-1, 1992 Low voltage Switch gear and Control gear assemblies Part-I, type tested and partially type tested assemblies.
2. IEC-947-1, 1998 Low voltage Switch gear and Control gear Part-I general rules.
3. IEC-1180-1, 1992 High voltage test techniques for low voltage equipment Part – I definition test and Procedure requirement
4. IEC-529, 1989 Degree of protection provided by enclosures (IP code)

EQUIPMENT SPECIFICATION

1. Air circuit breaker (ACB)

These shall be fixed type with manually operated mechanism microprocessor based. The short circuit mechanism and breaking capacity as shall be supported by test certificate. The test certificates should be from CPRI / ERDA/any Govt. approved recognized test house / laboratory.

The circuit breaker shall be fitted with CT operated thermal overload and short circuit releases devices for current rating 800/1250/1600Amps.

- a) Overload releases should be settable from 50% to 100% of the rated current I_n .
- b) Ambient temperature compensated type and there should not be de-rating of ACB current carrying capacity at 40°C. The testing of ACB for the temperature rise shall be carried out by the manufacturer as per the prevailing, IS / IEC or any other international standards.
- c) ACB shall be provided with overload and short circuit release. Short circuit release should have settable value of 15kA to 25kA with a adjustable times having setting range of 40 – 460 m seconds, to have a proper co-ordination with short circuit release of outgoing MCCBs.
 - 1) 3 phase, 4 wire, neutral earthed having link arrangement.
 - 2) Rated current thermal current- 250/400/800/1250/1600Amps
 - 3) Service voltage - 415 volts
 - 4) No. of break / pole - one
 - 5) Frequency - 50 c / s
 - 6) Rated insulation voltage - 1000 volts
 - 7) Rated short circuit breaking capacity
Rated services S/C breaking capacity I_{cs} (rms) – 50kA
Rated ultimate S/C breaking capacity I_{cu} (rms) – 50kA
 - 8) Break Time - less than 40ms
 - 9) S/C making capacity 1cm (peak) - 143kA
 - 10) Rated short time withstand current: I_{cw} 50kA for 1 sec.
 - 11) Suitable for outdoor installation.
 - 12) It shall conform to IS 13947 / pt.2 / 1993, IEC 60947-2&3 with latest amendment, if any.
 - 13) Performance category: Utilization category – B with operation cycle O – t – Co – t – Co.
 - 14) The status of open and close shall be clearly visible.
 - 15) The trip indication separated for overload and individual phase wise trip indication for short circuit to be provided.
 - 16) The ACB shall have the provision to lock the operating mechanism in off position.
 - 17) The operating mechanism should be from front and the compartment should have the degree of protection IP – 54.
 - 18) Separator shall be provided between all phases inside. ACB enclosed to prevent travel of arc during short circuit.
 - 19) The CTs mounted for thermal overload release shall have secondary winding inaccessible including tripping mechanism of O/L and magnetic releases to avoid tampering CTs should also have provision of separators.
 - 20) Two nos. earthing bolts for propose of earthing of ACB may also be provided & suitable for G.I stay wire of size 7 / 10 SWG.
 - 21) The bus bar size shall be confirming to relevant IS and the neutral bus bar shall be of same wire of size as phase bus bar and should be suitable for connecting neutral.
 - 22) The ACB shall be tested in accordance with the provision of IS 13947 – Part I or relevant IEC.

2. Moulded case circuit breaker (MCCB)

L.T. section with one MCCB/ACB as incoming and following outgoing MCCB feeders and with enclosure made of electronically Galvanized sheet (min 2 mm Thickness) with powder coated finish, Cu bus bar with LT Metering facility . IEC 60947-2.				
Sl. No	Transformer	No. of MCCB	Capacity of MCCB 4 pole 50KA, TM Based	Incomer for LT
1	100kVA Al. Winding	2	100A	250A MCCB, 50kA, 4 pole Fixed Type Micro Processor based
2	250kVA Al. Winding	3	250A	400A MCCB, 50kA, 4 pole Fixed Type Micro Processor based
3	500kVA Al. Winding	7	250A	800A ACB, 50kA, 4 pole Fixed Type Micro Processor based
4	800kVA Cu winding	6	250A	1250A ACB, 50kA Fixed Type 4 pole Micro Processor based
5	1000kVA Cu winding	7	3 x 400A 4 x 250A	1600A ACB, 50kA Fixed Type 4 pole Micro Processor based

The MCCB should be suitable for connecting LT 3 ½ C x 400sqmm XLPE cable. Connection between transformer LT terminal to ACB and MCCB shall be through copper bus bars.

3. Interconnecting bus bar

Bus bar shall be of high conductivity copper supported on insulators made of non-hygroscopic, non-inflammable material with tracking index equal to or more than that defined in BIS. The main bus bars shall have uniform current ratings throughout their length as specified in data sheet / job specification. The current rating of the neutral shall be half that of the phase busbars. Removable neutral links shall be provided on feeders to permit isolation of the neutral bus bar.

Both horizontal and vertical bus bars, bus joints and supports shall be capable of withstanding dynamic and thermal stresses of the specified short circuit currents for 1 second. Only zinc passivated or cadmium plated high tensile strength steel bolts, nuts and washers shall be used for all bus bar, joints and supports. The short circuit capacity of the neutral bus bars shall be in line with IS: 13947.

The hot spot temperature of bus bars including joints at design ambient temperature shall not exceed 95°C for normal operating conditions.

The current rating of the bus bars shall be 250/400/800/1250/1600A for design ambient temperature at site conditions and for being inside the cubicle at fully loaded condition. The vendor shall suitably de-rate the nominal rating to suit the above condition.

All bus bars shall be insulated with heat shrink PVC sleeves of 1100V grade, red yellow and blue color shall be used for phase bus bars and black color shall be used for neutral bus bars. Removable type shrouds shall be provided for joints.

Minimum clearance between live parts, between live parts / neutral to earth shall be 19mm. However, clearances between terminals at components shall be as per applicable individual standard for components.

Interconnections between the main bus bars and individual units shall be made using vertical / horizontal copper bus bars of adequate rating shall be used.

4. Tri-vector meter and CTs

Suitable cut out shall be provided on LT compartment for installing Tri-Vector meter (Tri-Vector meter and its details shall be provided by BESCO). CT's 04 Nos. & potential connection for metering shall be provided in the LT compartment. The details are as under.

CT's with accessories: CT's of rating as specified below are to be provided, mounted on the Transformer L.T busbar.

Sl. No	Particulars	Requirement
1	100/250/500/800/1000kVA	250/5A,400/5A,800/5A,1250/5 1600/5Amps
2	Class of Accuracy	0.5
3	Burden	15 VA
4	Type	Resin Cast, Suitable for Outdoor use

The Secondary Terminals of the CT's shall be individually wired, using 2.5 sq mm flexible copper wires (with color coding, and ferrules at both ends) up to a Terminal block. Terminal Block shall be located, at a suitable height. The three phase voltages also are to be tapped from the L.T busbar and wired up to the terminal block. The C.T secondary shall be covered with sealable covers.

5. Auxiliary supply

3phase with neutral, 440V AC supply shall be tapped from main bus bar after the ACB for supply to exhaust fan, lighting of the substation and Control supply for RMU etc. Necessary protection in incomer and outgoing shall be provided.

D. SPECIFICATION FOR ENCLOSURE FOR PACKAGE SUBSTATION

The package substation shall have the following features.

1. Enclosure for the package substation shall be made of electronically galvanized sheets and MS sheets are not accepted.
2. Separate compartment for 11 kV Compact RMU, Distribution Transformer & LT Switchgear
3. Door of the HT and LT compartment shall be designed such as complete door is divided into minimum two-fold / parts vertically for minimum space requirement while opening.
4. Painting shall be tested for radiation test.
5. The painting specification and color shade of the enclosure shall be approved by the BESCO.
6. There should be proper earthing arrangement for the entire substation i.e., 11 kV Compact RMU, Distribution Transformer & LT Switchgears along with the enclosures.

7. Design of Transformer Compartment shall be such to accommodate oil type 100/250/500/800/1000KVA transformers, and it shall be possible to interchange any of these transformers.
8. Barrier shall be provided between MCCB.
9. Non-metallic phase separator shall be provided between the three phases connected to MCCB.
10. Layout of package substation shall have approval of Chief Electrical Inspector. It is the responsibility of bidders to make changes as per the requirement of Chief Electrical Inspector, without any time and cost implication to the purchaser.
11. Suitable cut out shall be provided on LT compartment for installing Tri-Vector meter (Tri-Vector meter and its details shall be provided by purchaser).
12. CT's & potential connection for metering shall be provided in the LT compartment.
13. The Packaged Substation should have adequate arrangements of ventilation and should be inclusive of all safety accessories like voltage detection rod, fire extinguishers, gloves etc. Adequate illumination is to be provided for Packaged Substation. There should be provision for providing enclosure around the entire Packaged Substation. There should be barrier for RMU section, Transformer section and LT Switchgear section for safety purpose. There should be easy access to all these three compartments independently.
14. The Packaged Substation should have ample arrangement to meet the requirements of protection of all electrical equipment's. The clearances between live parts and minimum clearances to earth have to be maintained to the respective standards. The size of the substation should be compact to meet the traffic and road requirements.
15. The bidder has to specify the total weight of the Packaged Substation.

RELAY CO-ORDINATION

Bidder shall ensure proper relay co-ordination between 11 kV RMU & LT ACB & LT MCCB and shall provide calculation in support of the same.

DIMENSION

The approximate base dimension for packaged substation shall be around **2 Mtr x 3 Mtr**. However, depending upon the design of the bidder, the same may be reviewed.

GUARANTEED TECHNICAL PARTICULARS FOR 11KV Non-Extensible Compact RMU

The bidder should fill up technical particulars of 11 kV panel in the following format)

Name of the Bidder:

Sr. No.	Description	RMU
1.0	SWITCHGEAR ASSEMBLY	
1.1	Make	
1.2	Type	
1.3	Reference Standard	
1.4	Voltage (Normal/Max.) kV	
1.5	Phase (Nos.)	
1.6	Frequency (Hz)	
1.7	Short Circuit Rating	
	a) Breaking Symmetrical (kA)	
	b) Breaking Asymmetrical (kA)	

	c) Short time for 1 Sec. d) Short time for 3 sec.	
1.8	Insulation Level	
	a) Impulse Withstand (kVpeak)	
	b) 1 minute 50 Hz. Voltage Withstand (kVrms)	
1.9	Metal Clad Construction	Yes/ No
1.10	Degree of protection :	
1.11	Switchgear completely wire and tested at factory :	Yes/ No
2.0	CONSTRUCTION	
2.1	Overall Dimensions	
a.	Breaker	
	i) Length (mm)	
	ii) Breadth (mm)	
	iii) Height (mm)	
b.	Isolator	
	a)Length (mm)	
	2) breadth (mm)	
	3) Height (mm)	
c.	Total Non-Extensible 3 Panel RMU	
	1) Length (mm)	
	2) Breadth (mm)	
	3) Height (mm)	
2.2	Weight	
	a) Breaker (kg)	
	b) Isolator (kg)	
	c) Non-Extensible 3 panel RMU (kg)	
3.0	Bus Bar	
3.1	Make	
3.2	Material & Grade	
3.3	Reference Standard	
3.4	a) Cross Sectional area (m m ²)	
	b) Size (m m ²)	
3.5	Continuous Current	
	a) Standard	
	b) At site conditions and within cubicle	
3.6	Maximum temperature rise over ambient (c)	
3.7.	Short time current for 3 Sec. (KArms)	
3.8	Minimum clearance from bare bus bar connection	
	a) Phase to phase (mm)	
	b) Phase to earth (mm)	
3.9	Bus Bar provided with	
	a) Insulation Sleeve	
	b) Phase barriers	
	c) Cast Resin shrouds for joints	
3.10	Bus bar connection	
	a) Silver Plated	
	b) Made with anti oxide grease	
3.11	Bus bar support spacing (mm)	
3.12	Bus support insulators	
	a) Make	
	b) Type	

	c) Reference Standard	
	d) Voltage Class (kV)	
	e) Minimum creepage distance (mm)	
	f) Cantilever strength Kg/mm ²	
	g) Net Weight (kG)	
4.0	SF6 / VCB CIRCUIT BREAKER	
4.1.	Make	
4.2.	Type	
4.3.	Reference Standard	
4.4.	Rated Voltage	
4.5	Rated Frequency	
4.6	No. of Poles	
4.7	Rated Current	
	a) Normal (Standard) Amps	
	b) Derated (Site) Amps	
4.8	Maximum temperature rise over ambient °C	
4.9	Rated operating Duty	
4.10	Rupturing capacity at rated voltage (MVA)	
4.11	Breaking capacity at rated voltage & operating duty	
	a) Symmetrical (kArms)	
	b) Asymmetrical (kArms)	
4.12	Rated making Current (kApeak)	
4.13	a) Short time current for 1 sec. (kArms)	
	b) Short time current for 3 Sec. (kArms)	
4.14	Transient Recovery Voltage	
	a) Rate of rise (kV/ms)	
	b) Peak Voltage (kV)	
4.15	Insulation Level	
	a) Impulse voltage withstand on 1/50 full wave	
	b) 1 minute 50 Hz. Voltage withstand	
4.16	Maximum over voltage factor when Switching off	
	a) Un loaded transformer	
	b) Loaded transformer	
	c) Un loaded cables	
	d) Capacitors	
4.17	Opening time maximum No load condition (ms)	
4.18	Opening and closing time under SF6 gas loss or vacuum loss condition (ms)	
4.19	At 100% Breaking capacity	
	a) Opening time-Max. (ms)	
	b) Arcing time-Max (ms)	
	c) Total break time (ms)	
4.20	At 60% breaking capacity	
	a) Opening time-Max. (ms)	
	b) Arcing time-Max. (ms)	
	c) Total break time (ms)	
4.21	At 30% breaking capacity (ms)	
	a) Opening time-Max. (ms)	
	b) Arcing time-Max. (ms)	
	c) Total break time (ms)	
4.22	At 10% breaking capacity (ms)	
	a) Opening time-Max. (ms)	

	b) Arcing time-Max. (ms)	
	c) Total break time	
4.23	a) Make time (Max) (ms)	
	b) Total closing time (ms)	
4.24	Number of breaks per pole	
4.25	Total length of breaks per pole (mm)	
4.26	Total length of contact travel (mm)	
4.27	Speed of break (100% short circuit current)	
4.28	Rate of contact travel	
	a) At tripping M/sec.	
	b) At closing M/sec.	
4.29	No. of breaker operations permissible without requiring inspection, replacement of contacts and other main parts.	
	a) At 100% rated current	
	b) At 100% rated breaking current	
4.30	Type of contacts	
	a) Main	
	b) Arcing	
4.31	Material of contact	
	a) Main	
	b) Arcing	
	c) Whether contacts silver plated	
	d) Thickness of silver plating	
4.32	Contact pressure at No load (Kg)	
4.33	Type of arc Control device provided	
4.34	Operating mechanism-closing	
	a) Type	
	b) No. of breaker operations stored	
	c) Trip free or fixed trip	
	d) Anti pumping features provided	
	e) Earthing for operating mechanism and metal parts furnished	
	f) Earth terminal size and material	
4.35	Operating mechanism-tripping	
	a) Type	
	b) No. of breaker operations stored	
	c) Trip free or fixed trip (V)	
	d) Anti pumping features provided (%)	
	e) Earthing for operating mechanism and metal parts furnished	
	f) Earth terminal size and material	
4.36	1Spring Charging mechanism 2Make 3Type 4Size 5rating	
4.37	Breaker suitable for capacity Switching Operating duty 4Max. rating of capacitor bank that can be safely Controlled	
4.38	Tripping Coil	
	a) Voltage	
	b) Permissible voltage variation (%)	
	c) Tripping Current at rated Voltage (A)	
	d) Power at rated voltage (W)	

	e) 2-Over current trip with 1- earth fault furnished as specified.	
4.39	Breaker/Accessories Accessories such as Control Switch indication lamps etc. furnished as specified: (Please attach separate sheet giving details of all accessories, inter locks and safety shutters)	
	a) Mechanical Safety Interlock	
	b) Automatic Safety Interlock	
	c) Operational Interlock	
	d) Emergency manual trip	
	e) Operation counter	
	f) Charge/discharge indicator	
	g) Manual spring charging facility	
4.40	Impact load foundation design (to include dead load plus impact value on opening at maximum interrupting rating) (Kg)	
5.0	Isolators	
5.1	Make	
5.2	Type	
5.3	Reference Standard	
5.4	Rated Voltage (KV)	
5.5	Rated Frequency Hz	
5.6	No. of Poles (No)	
5.7	Rated Current Normal (Standard) Derated (Site) Amp	
5.8	Maximum temperature rise over ambient °C	
5.9	Rated Operation duty	
5.10	Rupturing Capacity at rated voltage MVA	
5.11	Rated making current KA Peak	
5.12	Short time current a) for 1 Sec KA RMS b) for 3 Sec KA RMS	
5.13	Impulse voltage withstand on 1/50 full wave b) 1 minute 50 Hz voltage withstand	
5.14	Maximum over voltage factor when Switching off a) Loaded feeder cable	
5.15	Minimum SF6 Gas pressure required	
5.16	No. of isolator operation permissible without requiring inspection, replacement of contacts and other main parts At 100% rated current At 100% rated breaking current	
5.17	Isolator provided with the following Mechanical safety Mechanical ON, OFF , CABLE EARTH indicators Operation counter Manual spring charging facility	
5.18	Impact load for foundation design (To include dead load plus impact values on opening at maximum interrupting rating) Kg	
6.0	CURRENT TRANSFORMER	

6.1	Make	
6.2	Type & voltage level	
6.3	Reference standard	
6.4	C.T. ratio as specified	
6.5	Rated frequency	
6.6	Short circuit withstand Short time current for 3 Sec. KA RMS ii) Short time current for 5 Sec. KA RMS iii. Dynamic current kA peak	
6.7	Class of insulation	
6.8	Temperature rise over ambient ° C	
6.9	Basic insulation level	
6.10	For tripping CT Ratio Class of accuracy Rated burden VA Knee point voltage V Excitation current at $V_k/2$ Amps Rated saturating current Amp Over current rating Continuous % over load (%)	
7.0	Secondary Wiring	
7.1	Type and insulation	
7.2	Voltage grade	
7.3	Conductor material	
7.4	Conductor size (minimum) and insulation wiring	
7.5	Wires identified at both ends with markers	
7.6	Wiring and other accessories provided as per specification.	
8.0	CABLE TERMINATIONS	
8.1	Circuit Breaker Type Material Dimensions Size Height of cable box from ground level Arrangement for supplying bus end cable box furnished for extensible ring main unit Arrangement for mounting an extra cable box on each equipment furnished	
8.2	Isolator Type Material Dimensions Size Height of cable box from ground level	
9.0	Name Plate	
9.1	Material	
9.2	Thickness	
9.3	Size for	
	a) Breaker cubicle	
	b) Instruments/devices	

10.0	Painting	
10.1	Finish of Breaker Inside outside	
10.2	Finish of Isolator Inside outside	
11.0	No. of Accessories Furnished	
	a) Earthing Equipment	
	b) Test Plug	
12.0	TESTS	
12.1	Reference Standard	
12.2	Routine tests to be performed on Switchgear	
12.3	Type Tests quoted	
13.0	Drawing/Data	
13.1	General arrangement for Panel Board	
13.2	Foundation plan	
13.3	SF6/VCB tripping & material schematic	
13.4	Bill of material	
13.5	SF6/VCB LT Panel Wiring Diagram	

**GUARANTEED TECHNICAL PARTICULARS FOR DISTRIBUTION TRANSFORMERS
SCHEDULE 'A' (To be furnished by the manufacturer)**

SI No.	Description	
1.	Make	
2.	Name of Manufacture	
3.	Place of Manufacture	
4.	Voltage Ratio.	
5.	Rating in kVA.	
6.	Core Material used and Grade.	
	a). Flux density.	
	b). Over fluxing without saturation (Curve to be furnished by the manufacture in support of his claim).	
7.	Maximum temperature rise of:	
	a. windings by resistance method	
	b. Oil by thermometer	
8.	Magnetising (no-load) current at:	
	a. 90%	
	b. 100%	
	c.110%	
9.	Core loss in watts	
	a. Normal voltage	
	b. Maximum voltage.	
10.	Resistance of windings at 20°C (with 5% tolerance)	
	a. HV Windings (ohms).	

	b. LV Windings (ohms).	
11.	Full load losses (watt) at 75°C	
12.	Total Losses at 100% load at 75°C	
13.	Total Losses at 50% load at 75°C	
14.	Current density used for : (Amper/sqmm)	
	a. HV Winding	
	b. LV Winding	
15.	Clearances : mm	
	a. Core and LV	
	b. LV&HV	
	c. HV Phase to Phase	
	d. End insulation clearance to earth	
	e. Any point of winding to tank	
16.	Efficiency at 75°C	
	a. Unity P.F. and	
	b. 0.8 P.F.	
	1.125% load	
	2.100% load	
	3. 75% load	
	4. 50% load	
	5. 25% load	
17.	Regulation at:	
	a. Unity P.F. and	
	b. 0.8 P.F. at 75°C	
18.	% Impedance at 75°C	
19.	Flash Test:	
	(i) HV 28kV/50HZ for 1 minute	
	(ii) LV 3kV/50Hz for 1 minute	
20.	Over potential test (Double voltage and Double frequency for 1 minute)	
21.	Impulse test in peak kVA.	
22.	Mass of : (kg)	
	a. Core lamination (minimum)	
	b. Windings (minimum)	
	c. Tank and fittings	
	d. Oil	
	e. Oil quantity (minimum) (litre)	
	f. Total weight	
23.	Oil Data:	
	1. Qunatity for first filling (minimum) (litre)	
	2. Grade of oil used	
	3. Maker's name	
	4. BDV at the time of filling (kV)	
24.	Transformer:	
	1. Overall length x breadth x height (mm x mm x mm)	
	2. Tank length x breadth x height	
	3. Thickness of plates for	
	a. Side plate (min)	
	b. Top and bottom plate (min)	
	4. Conservator dimensions	
25.	Radiation:	
	1. Heat dissipation by tank walls excluding top and bottom	

	2. Heat dissipation by cooling tube	
	3. Diameter and thickness of cooling tube	
	4. whether calculation sheet for selecting cooling area to ensure that the transformer is capable of giving continuous rated output without exceeding temperature rise is enclosed	
26.	Inter layer insulation provided in design for:	
	1. top and bottom layer	
	2. In between all layer	
	3. Details of end insulation	
	4. Whether wedges are provided at 50% turns of the HV coil	
27.	Insulation materials provided	
	a. For conductors	
	1. HV	
	2. LV	
	b. For core	
28.	Material and size of the wire used	
	1. HV Dia (mm) SWG	
	2. LV a) Strip size	
	b) No. of conductors in parallel	
	c) Total area of cross section (sq.mm)	
29.	Whether the name plate gives all particulars as required in tender	
30.	Particulars of bushings HV/LV	
	1. Maker's name	
	2. Type IS:	
	3. Rating as per IS	
	4. Dry power frequency voltage withstand test	
	5. Wet power frequency voltage withstand test	
31.	Type of insulation used in	
	a. HV windings	
	b. LV windings	
32.	Type of insulation used on	
	a. Core bolts	
	b. core bolt washers	
	c. Core laminations	
33.	whether conservator is provided	
34.	whether breather is provided	
35.	Approximate overall dimensions	
	a. height	
	b. Breadth	
	c. Length	
36.	Weight of insulated conductor	
	a. HV	
	b. LV	
37.	a. Weight of core	
	b. Tolerance	
38.	a. weight of complete Transformer for transport	
39.	Period for which this design of transformer has been in commercial use	
40.	Reactance of windings at 75 ° C/ph	
	a.HV b. LV	

41.	Resistance of rated current and frequency a. HV b.LV	
42.	Bushing characteristics Normal power frequency with voltage stand voltage (kV) Dry(kV) Wet (kV) 11kV 28 28 0.433kV 3 3	
43.	Material of bushing rod and nuts	
44.	Date of commencement of production of distribution transformer at the factory of the supplier	

SCHEDULE 'A1'

Sl.No.	Particulars	
1.	Tank	
	a. Wall thickness mm	
	b. Top/bottom plate thickness mm	
	c. Welding of plates	
	d. Side wall joints	
	e. General	
	i. Reinforcement for walls	
	ii. Limits for permanent deflection	
	iii. channel (bore) mm	
2.	Core (Magnetic circuit)	
	a. Top yoke (single sheet) Thickness mm	
	b. Channel liner	
	c. Core wrapper	
	d. Core clamping	
	e. Core dimensions	
	i. height (window)	
	ii. Core diameter	
	iii. Limb centre	
	f. No load current (% of FL current)	
	g. No load loss in watts	
	h. Core material	
	i. Core fixing bolt \varnothing mm	
	j. Tie rod insulation mm paper	
3.	Winding (Electrical circuit)	
	a. Conductor material	
	b. Conductor insulation	
	i. HV winding	
	ii. LV winding	
	c. Conductor size	
	i. HV winding mm ²	
	ii. LV winding mm ²	
4.	Phase barrier board (press board)	
	a. Spacer between HV & LV coils	
	b. Coil end insulation mm	
	c. coil packing screw	
	d. HV jumper & delta formation	

	e. LV jumper mm	
	f. HV termination (bushing)	
	g. LV termination (bushing)	
	h. Spacers	
	i. Load loss at 50% and 100% load in watts	
	j. Percentage of impedance 75° C	
	k. Neutral current at full load in %	
5.	a. Coil packing	
	b. Tapping lead Cu mm	
	c. Neutral current	
	d. Breather (Silica gel)	

Note:

The following shall be specifically confirmed:

16. Whether the offer conforms to the limits of impedance mentioned in the specification
17. Whether the offer conforms to the limits of temperature rise mentioned in the specification
18. Whether the losses of the transformers offered are within the limits specified
19. Whether the transformers offered is already type tested for the design and test reports enclosed.

Annexure-A

Welding of Unique ID Number plate (Stainless Steel) on the Distribution Transformer Tank for Distribution Transformer Tracking System(DTTS).

The Design for SS plates to be welded as given below.

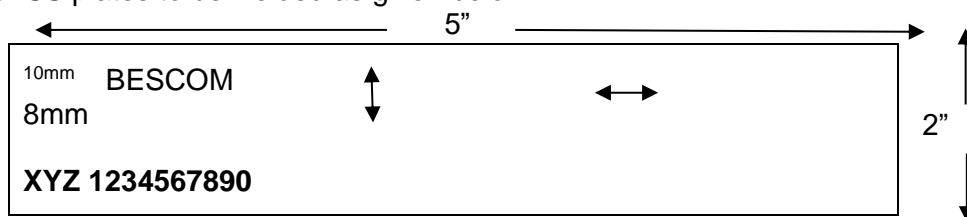

Transformer Name Plate Dimensions

- Length = 5"
- Width = 2"
- Thickness= 1mm
- Material = Stainless Steel (SS)
- Unique ID code= a) First three letters (initials of Manufacturer as approved/to be approved by BESCOM) followed by 10 digit serial no.
- Unique ID code with BESCOM shall be punched on stainless steel plate and the same shall be welded on transformer tank. The unique ID code with initials of manufacturer & 10 digit code shall be punched on the top cover, on the transformer tank and also shall be embossed /engraved on the rating plate.
- The punched Unique ID code& BESCOM initials on stainless plate shall be painted with Black color & shall be visible from the ground.

NOTE:

TERMINAL MARKING PLATE AND RATING PLATES SHALL BE PROVIDED IN ACCORDANCE WITH IS 1180 IN ADDITION TO UNIQUE ID STAINLESS STEEL PLATE MENTIONED ABOVE:

The transformer shall be provided with an anodized aluminum/stainless steel plate securely fixed on the outer body showing the relative physical position of the terminal and their markings. This shall be in accordance with IS: 1180(Part1):2014. The transformers shall be provided with rating plate furnishing the information as specified in 1180(Part1):2014. The month and year of delivery shall be indicated on the rating plate. The rating plate shall be embossed / engraved type but not painted. The serial No. of transformer shall follow the code Nos. as detailed in annexure B. These shall be punch marked on the transformer tank and also on the top cover.

Annexure B**Procedure for assigning Unique ID code to Distribution Transformers:**

Alpha code	Numeric code	Numeric 1	Numeric 2	Numeric 3&4	Numeric 5&6	Numeric 7,8,9&10
3 digit code assigned to manufacturer by BESCO		Star Rating	capacity	Year of manufacture	Month of manufacture	SI.No of the Transformer as assigned by the manufacturer
Example: SI.No :XYZ 1315063456						
XYZ		1	3	15	06	3456

Unique ID code: XYZ 1315063456. XYZ denotes First three letters (initials of Manufacturer as approved/to be approved by BESCO) 3 star rated 63kVA distribution Transformer manufactured in the month of June during the year 2015 with SI.No.3456.

a) Alphanumeric codes (3 Digits)

Alphanumeric code (3 digit)	Name of the Company	Remarks
XYZ	---	3-digit alpha numeric code assigned to manufacturer by BESCO

b) Details of the 10 Digit code.

Digit	Digit codes	Description of the Digit Code
1 st Digit	0,1, 2 or 3	0- Conventional (Un starred)
		1 – BEE-3 Star
		2- BEE-4 Star
		3- BEE-5 Star
2 nd Digit	1 to 9	1- 15 KVA Capacity
		2-25 KVA Capacity

SECTION 8B : TECHNICAL
SPECIFICATIONS

		3- 63 KVA Capacity
		4- 100 KVA Capacity
		5- 250 KVA Capacity
		6- 300 KVA Capacity
		7 - 500 KVA Capacity
		8- 750 KVA Capacity
		9 -990/1000 KVA Capacity
3rd & 4th Digit	15 or 16 etc.,	Year of Manufacture that is 2015 or 2016 etc
5th & 6 th Digit	01 to 12	Month of Manufacturing
		01-Jan, 02-Feb,03-March etc., up to 12-Dec
7th to 10 th Digit	0001 to 9999	Sl. No. of the transformer

SECTION – 3
**RMU: DAS RMU FOR OUTDOOR USE IN 11KV
DISTRIBUTION CABLE SYSTEM**

Technical specification for DAS Ring Main Unit

1 Introduction

This document contains the Technical Specifications that apply to DAS Ring Main Units of 3-Way, 4-Way and 5-Way configurations, which covers the supply of Ring Main Units (RMUs).

2. Key RMU Components

Key RMU components are listed as follows:

- Two (2) load break switches (LBSs) with earthing switches, also known as Operating Devices (ODs), connecting the RMU to incoming and outgoing main loop, 11 kV, 630 Amp capacity capable to connect XLPE cables of size 240/400 mm² cross section.
- One (1) to three (3) circuit breakers (CBs) with earthing switches, also known as Vertical Lines (VLs), connecting the RMU to distribution loop, 11 kV, 400 Amp capacity capable to connect XLPE cables of size 95/240 mm² cross section.
- One (1) to three (3) numerical relays for overcurrent (OC) and earth fault (EF) protection in conjunction with the corresponding circuit breaker(s).
- One (1) Fault Passage Indicator (FPI) in the RMU's main loop circuit to provide indications that feeder downstream phase or earth faults have occurred.
- All necessary voltage and current sensors for metering and protection.
- All necessary dry (potential-free) contacts for indications relevant to RMU monitoring and control.
- Two (2) multifunction meters serving as Intelligent Electronic Devices (IEDs) to provide voltage, current, power, energy and power factor readings that correspond to the RMU's main-line circuits.
- A power supply unit, including auxiliary power transformer and battery backup, to provide stable 24 V DC and 12 V DC sources of power for a separately supplied RTU and radio respectively as well as necessary sources of power for the RMU's spring-charge motors, FPI, relays, and multifunction meters. The power supply shall also provide for RMU enclosure lighting fixtures and power-plug receptacles for maintenance/test equipment.
- Capacitor voltage dividers serving live-line cable indicators.

A typical five-way RMU configuration is illustrated in Figure 1-1. In this case, the RMU has six enclosures, one for each of the two load break switches, one for each of the three circuit breakers or VLs, and one for the RMU's auxiliary power supply unit and the necessary SCADA monitoring and control equipment. The SCADA monitoring and control equipment includes the RTU and radio as supplied by others and referenced elsewhere in these specifications.

3. Ring Main Units

Each RMU shall include its own power supply unit (including auxiliary power transformer, batteries, and battery charger), which shall provide a stable power source for not only the RMU, but also the RTU and radio that the RMU must be capable of housing.

Figure 1-1: Typical RMU Configuration

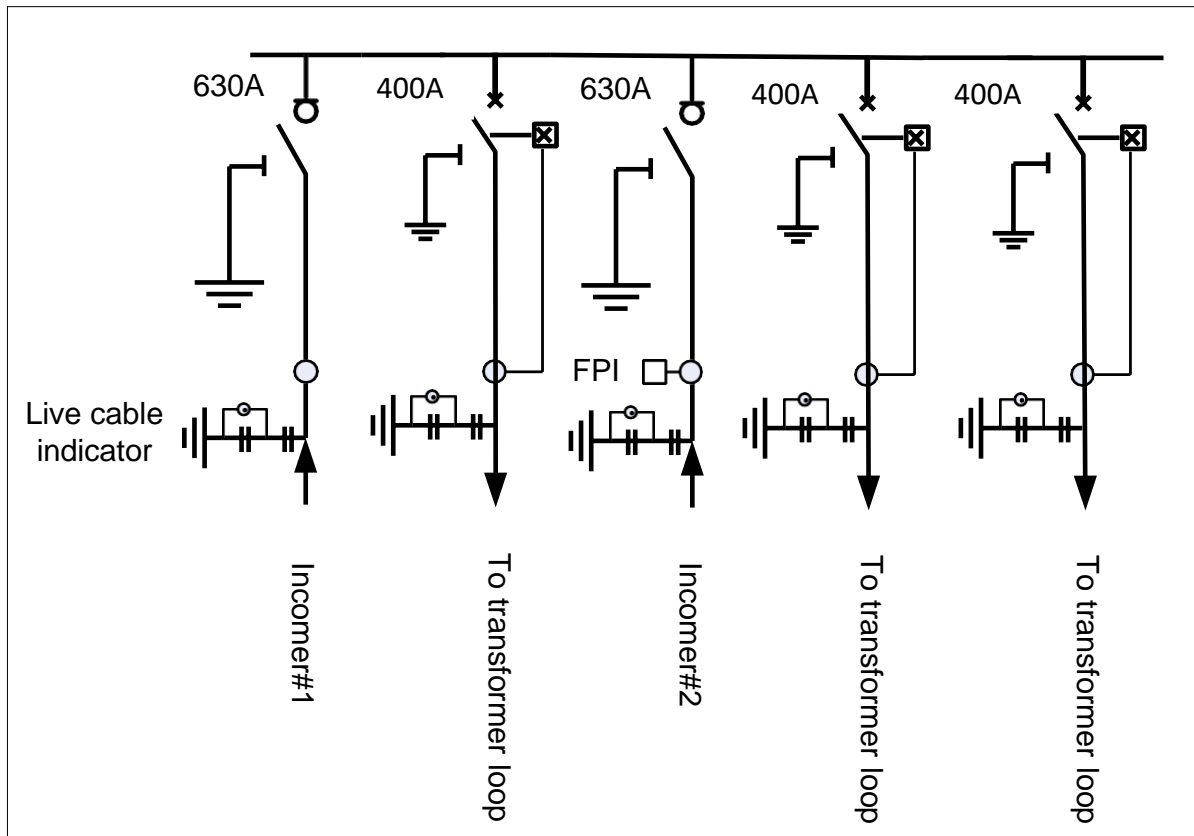

Each new RMU shall be equipped with main-line load break switches and a fault passage indicator (FPI). Furthermore, to protect each of its lateral circuits, it shall be equipped with a corresponding set of circuit breakers and numerical relays. The RMU interrupters of reputed make shall be enclosed in an SF₆ or vacuum medium and the RMU will include all necessary voltage and current sensors and potential-free contacts so that, as a minimum, the DAS via its RMU remote interface can:

- Monitor and control the open/closed status of the RMU circuit breakers and load break switches.
- Monitor the local/remote position of RMU manually-operated switches that can be used to enable and disable remote monitoring and control of individual ODs (Operating Device) and VLs (Vertical Lift).

- Monitor the health of the power supply, which will include battery failure and low voltage indications.
- Monitor the open/closed status of RMU earthing switches.
- Monitor the open/closed status of RMU enclosure doors.
- Monitor for low SF₆ gas pressure readings.
- Monitor circuit breaker and load break switch spring charge (switch readiness) status.
- Monitor for circuit breaker relay operations.
- Monitor for main-circuit fault currents detected by the RMU's FPI (Fault Passage Indicator).
- Monitor the number of operations of the RMU's circuit breakers and load break switches.
- Monitor voltage, current, power, energy, and power factor values corresponding to the RMU's main circuits and the phase currents corresponding to the RMU's lateral circuits.

4. Specification Organization

These Technical Specifications for DAS RMUs are organized as follows:

- **Clause 1: RMU Design Features.** This clause includes design features related to RMU availability, maintainability, expandability, life span and relevant physical and electrical properties.
- **Clause 2: RMU Characteristics.** This clause describes the main characteristics that relate to the functional and design aspects of RMU components such as line sensors, FPIs, protection relays, multi-function meters, motors, auxiliary transformers, power supply equipment, and enclosures.
- **Clause 3: Inspection and Test.** This clause includes requirements related to inspections, test procedures, test records, factory acceptance tests, site acceptance tests, and commissioning.

5. Applicable Standards

The RMUs shall be manufactured to the highest quality consistent with best practice and workmanship and in full accord with the Contractor's quality assurance plan. The RMUs and the work associated with their installation shall also conform to the Indian and equivalent international standards that are applicable. These include the standards listed in Table 1-1 below.

The Contractor shall provide an English language copy of the applicable Indian and equivalent international standards met by the proposed RMU.

6. Environmental Conditions

All materials supplied shall be capable of operating without fault in a tropical climate, which exhibits a high level of ultra-violet radiation and severe thunderstorms. Relevant environmental conditions are listed as follows:

- Maximum ambient air temperature: 45 °C
- Minimum ambient air temperature: 10 °C
- Maximum relative humidity: 90 %
- Average thunder storm days per annum: 50
- Average rainfall per annum: 900 mm
- Maximum wind speed: 119 km/hr
- Altitude above mean sea level: 1000 m

7. Distribution Network Electrical Parameters

The main parameters of the BMAZ distribution network are as follows:

- Nominal system voltage: 11 kV (rms)
- Highest system voltage: 12 kV (rms)
- Number of phases: 3
- Frequency: 50 Hz
- Variation in frequency: 49 Hz to 50.5 Hz
- Type of earthing: Solid
- Power frequency withstand voltage: 28 kV
- Basic impulse withstand voltage: 75 kV

Table 1-1: Applicable Standards

Standard	Description
IS 3427	AC metal enclosed switchgear and control gear for rated voltages above 1 kV and up to and including 52 kV
IS 12063	Classification of degrees of protection provided by enclosures of electrical equipment
IS 9920 (Parts 1 to 4)	High Voltage Switches
IS 9921 (Parts 1 to 5)	Specification for AC disconnectors and earthing switches for voltages above 1000 V
IS 13118	HV AC Circuit Breakers
IS 10601	Dimensions of terminals of HV Switchgear and Control gear
IS 12729	General requirements of switchgear and control gear for voltages exceeding 1000 V
IEC 1330	High voltage/Low voltage prefabricated substations
IEC 60694	Common clauses for MV switchgear standards
IEC 6081	Monitoring and control
IS 2705	Current Transformers
IS 3156	Voltage transformers
IS 8686	Specification for Static Protective Relays
IEC 62271-200	Standards for high voltage metal clad switchgear up to 52 KV.

8. Testing

The specified RMUs shall be subject to type tests, routine tests, and acceptance tests. Where applicable, these tests shall be carried out as per the standards stated above. Prior to testing, the Contractor shall prepare and submit a detailed test plan for review and approval by the Employer.

9 RMU Design Features

All design features of the proposed DAS RMU, shall be fully supported by the equipment actually delivered. The key design features include those that relate to:

- Availability, maintainability, expandability, and life span
- Ability to operate in severe outdoor environmental conditions
- Immunity to electrical stress and disturbance
- Acceptable insulation properties
- Acceptable surge suppression characteristics
- Convenient RTU interconnection features

In these and all other specified respects, the RMU shall meet or exceed the cited standards or, where appropriate, other equivalent industry standards.

1. Availability, Maintainability, Expandability, and Life Span

1.1.1 Availability

The RMU shall be designed to have a fully enclosed metal housing combined with the single-phase insulation of all primary live parts to reduce the risk of internal faults to an absolute minimum and to provide a high degree of safety as well as availability. Nevertheless, manufacturer standard designs shall be used to the fullest extent possible.

Each RMU shall exhibit an availability of greater than 99.5%. To ensure this high degree of availability, the RMUs shall be fabricated, assembled, and finished with workmanship of the highest production quality and shall conform to all applicable quality control standards. All materials comprising the RMU shall be new, unused, and of the best industrial grade, and the RMU shall incorporate all recent improvements in both design and materials. All components shall be of current production from reliable component manufacturers.

1.1.2 Maintainability

The Employer intends to be self-reliant for RMU maintenance. To this end, the Contractor shall provide the support, documentation, and training necessary to operate and repair the RMU. This shall include, but shall not be limited to the maintenance manuals and repair kits applicable to the Contractor's RMU design.

The Employer prefers RMU designs that do not require periodic preventive maintenance and inspections.

To facilitate expansion and maintenance, modularity shall be employed in the design of the equipment. All major subassemblies shall carry permanent labels providing a cross-reference to the Contractor's corresponding documentation.

1.1.3 Expandability

The RMUs shall be designed such that, in the future, they can be expanded to accommodate additional enclosures containing circuit breakers and associated equipment that will allow the RMU to supply power to additional distribution circuits. In this respect, for example, the 3-way RMU shall be expandable in the field to a 5-way RMU.

1.1.4 Life Span

Each RMU shall have a design life of at least 20 years from the date of final acceptance. The Contractor shall make available, at no cost to the Employer, the manufacturing designs, drawings, and the rights to manufacture any subassemblies that the manufacturer will not support or discontinues to support during this life span. The specific components of each sub-assembly shall be identified and referenced in Contractor-supplied documentation.

2. Outdoor Features

2.2.1 General

The RMUs shall be designed specifically for outdoor installation and, in this respect, shall be suitable for continuous operation in a tropical climate that includes exposure to severe frequently occurring thunderstorms. They shall also be suitable for conditions in which they will be exposed to heavy industrial pollution, salt-spray, and high levels of airborne dust.

The equipment in the proposed outdoor RMU shall be conformably coated to meet these climatic conditions. In this respect, standards such as IEC 60870-2-2 covering equipment, systems, operating conditions, and environmental conditions shall apply

along with IEC 60721, which covers the classification of such conditions. In particular, the RMU equipment shall have been type tested for continuous operation under the environmental conditions.

In addition to the above, materials promoting the growth of fungus or susceptibility to corrosion and heat degradation shall not be used, and **steps shall be taken to provide rodent proof installations.**

2.2.2 Corrosion Protection

Except for stainless steel, all steel surfaces that are not galvanized shall be treated to protect against corrosion. As a minimum, corrosion treatment shall include the following procedures:

- The surface shall be cleaned to bare material by mechanical or chemical means.
- One or more phosphatizing or priming coats of paint shall be applied to the bare surface using a zinc-based or lead-based primer.
- A finish coat with high scratch resistance or epoxy powder finish paint shall be applied over the primer. The coat thickness shall be of the order of 50 to 70 micrometers. The Employer shall approve the finish-coat color. The RAL-code will be agreed upon with the Contractor during the early design phases of project implementation.

2.2.3 Galvanizing

Except for stainless steel, and unless otherwise stated, all structural steel and all exterior and interior steel surfaces of the RMUs, as well as nuts and bolts associated with galvanized parts, shall be hot-dipped galvanized in accordance with IS 802 or an equivalent international standard.

3. Immunity to Electrical Stress and Disturbance

The electrical and electronic components of the DAS RMU shall conform to relevant standards concerning insulation, isolation, and immunity from electromagnetic interference, radiated disturbance, and electrostatic discharge. The ability to meet these requirements shall be verified by type tests carried out by accredited test laboratories that are independent of the bidder and/or the manufacturer of the RMU components. Certified copies of all available type test certificates and test results shall be furnished prior to supply.

4. Minimum Insulation of Equipment

The RMUs shall be of SF₆ gas-insulated type. Otherwise, from an insulation perspective, the DAS RMU shall be designed so as to minimize exposure to electrically live terminals when visual inspection or maintenance of the internal components is being conducted.

5. Surge Voltage Suppression

The DAS RMU equipment shall be designed to operate on input power containing voltage spikes. Equipment shall be protected against part failure or malfunction such as intermittent firing of triggering devices due to surge voltage spikes occurring randomly over the instantaneous supply voltage.

6. Nameplate Information

RMU nameplate information shall be determined in agreement with the Employer. This information may include for example:

- Name of manufacturer and country
- Type, design, and serial number
- Rated voltage and current
- Rated frequency
- Rated symmetrical breaking capacity
- Rated making capacity
- Rated short time current and its duration
- Rated lightning impulse withstand voltage
- Purchase Order number and date
- Month and year of supply

Each DAS RMU shall also exhibit a Danger Board to indicate the presence of high voltage (11000V).

7. Interconnecting Cables, Wiring, Connectors, and Terminal Blocks

The Contractor shall provide all interconnecting wires, cables, connectors, terminations and other wiring accessories such as terminal blocks required by the RMU.

7.1 Metallic Cables

All metallic cables and wiring shall be of required cross-section solid or multiple strands of round copper conductors and have flame retardant insulation. All wiring shall be neatly laced and clamped.

All wire and cable connectors and terminators shall be permanently labelled for identification. All connection points for external cables and wires shall be easily accessible for connection and disconnection and shall be permanently labelled. Conductors in multi-conductor cables shall be individually color-coded.

7.2 Connectors

Plug-type connectors with captive fasteners shall be used for all interconnections. The connectors shall be polarized to prevent improper assembly.

7.3 RMU-RTU Connectors

For ease of installation and maintenance, the interconnection between the RMU and the RTU, i.e., the RTU to be installed by others in a separate RMU enclosure, shall be supported by having a multi-pin connector installed in each and every DAS RMU enclosure.

To accommodate all of the DAS RMU equipment points to be monitored and controlled, the connector installed in the enclosure (the Control Cabinet) containing the RTU shall in all cases be sized to accommodate a 5-way RMU, e.g., whether the RMU is 3-way or 5-way, the connector for interconnecting the RMU and RTU shall consist of six (6) multi-pin connectors as illustrated in Figure2-1.

The following concepts shall apply:

- The Control Cabinet's fixed connector shall consist of 6 individual multi-pin connectors having 24 female inserts and contacts capable of being wired to the RTU and to single multi-pin connectors of female type fixed within the other RMU enclosures via separate hooded plugs having 24 male inserts and contacts attached to cables of suitable length. The RTU male connector and its cable will be provided by the RTU contractor.
- All cabling for the RMU's analog and status input points, control output points, and auxiliary contacts shall be brought out to the single multi-pin connectors in the RMU enclosures. Modbus communication cable shall be adequate size (Minimum 1.5 sqmm) with outer sheath screen cable
- Wiring between the single female connectors in the OD and VL enclosures and the female connectors in the Control Cabinet shall take the form of Contractor-provided cables having at both ends a corresponding male

connector.

- The female multi-pin connectors shall contain a locking lever so that, in combination with the male connectors, they shall act as a mechanical locking device between male and female connector pairs. The lever shall only be fully locked if the two connectors are mated correctly.

7.4 Terminal Blocks

Apart from the connectors described above Clause, heavy-duty terminal blocks with screw type terminals for 5 mm minimum machine screws shall be provided by the Contractor for other necessary metallic cable terminations. Terminals for auxiliary relays shall equal or exceed the relay wiring requirements. In using a terminal block, no more than two cables or wires shall be connected to any of its individual terminals.

Self-extinguishing fireproof vinyl marking strips shall be used to identify all external connection blocks. Marking tags shall be read horizontally. All terminals to which battery or other high voltages are connected shall be provided with fireproof covers.

All individual status input, AC voltage input, and control output points shall be isolatable without the need to remove wiring by means of individual terminal blocks of the removable link type. In order to avoid open circuits on the secondary side of CTs, termination blocks with by-pass bridges shall be provided for all AC current inputs.

Terminal blocks shall comply with IEC 60947-7-1 (2009): Low-voltage Switchgear and Control Gear, Part 7-1: Ancillary Equipment, Terminal Blocks for Copper Conductors.

Figure 2-1: RMU/RTU Connector Pin-Out

Pin nrs	LBS 1	Pin nrs	LBS 2	Pin nrs	Miscellaneous	Pin nrs	CB1	Pin nrs	CB2	Pin nrs	CB3
1 2	LBS 1: closed	1 2	LBS 2: closed	1 2	SF ₆ Pressure: low	1 2	CB 1: closed	1 2	CB 2: closed	1 2	CB 3: closed
3 4	LBS 1: open	3 4	LBS 2: open	3 4	Charger AC: fail	3 4	CB 1: open	3 4	CB 2: open	3 4	CB 3: open
5 6	Spring 1: charged	5 6	Spring 2: charged	5 6	Voltage DC: low	5 6	Spring 1: charged	5 6	Spring 2: charged	5 6	Spring 3: charged
7 8	Earth switch 1: closed	7 8	Earth switch 2: closed	7 8	Battery alarms: Battery-failed, etc.	7 8	Earth switch 1: closed	7 8	Earth switch 2: closed	7 8	Earth switch 3: closed
9 10	Earth switch 1: open	9 10	Earth switch 2: open	9 10	Spare	9 10	Earth switch 1: open	9 10	Earth switch 2: open	9 10	Earth switch 3: open
11 12	Spare	11 12	FPI: overcurrent operated	11 12	Spare	11 12	Overcurrent relay 1: operated	11 12	Overcurrent relay 2: operated	11 12	Overcurrent relay 3: operated
13 14	Spare	13 14	FPI: earth fault operated	13 14	Spare	13 14	Earth fault relay 1: operated	13 14	Earth fault relay 2: operated	13 14	Earth fault relay 3: operated
15 16	LBS1: Local/Remote Status	15 16	LBS2: Local/Remote Status	15 16	Spare	15 16	CB1: Local/Remote Status	15 16	CB2: Local/Remote Status	15 16	CB3: Local/Remote Status
17 18	LBS 1 control: close	17 18	LBS 2 control: close	17 18	Spare	17 18	CB 1 control: close	17 18	CB 2 control: close	17 18	CB 3 control: close
19 20	LBS 1 control open	19 20	LBS 2 control open	19 20	Spare	19 20	CB 1 control: open	19 20	CB 2 control: open	19 20	CB 3 control: open
21 22	Door: open	21 22	Door: open	21 22	Spare	21 22	Door: open	21 22	Door: open	21 22	Door: open
23 24	Spare	23 24	FPI: reset	23 24	Spare	23 24	Spare	23 24	Spare	23 24	Spare

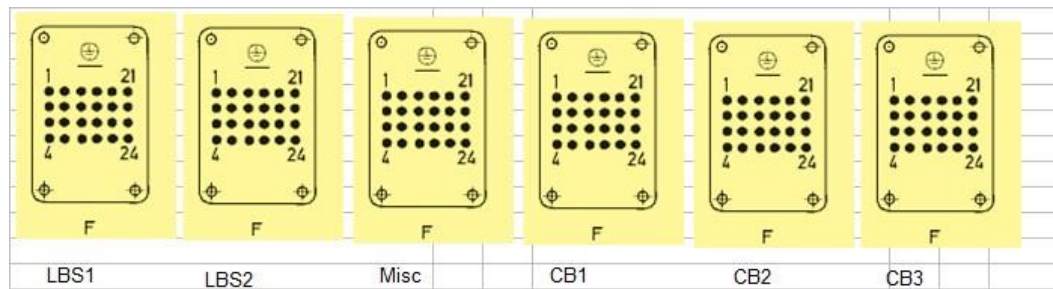

10 RMU Characteristics

As a minimum, the RMUs shall be equipped with main-line load break switches and a fault passage indicator (FPI), circuit breakers, and numerical relays for the protection of laterals, and multifunction meters providing voltage, current, power, energy, and power factor readings. The Load Break Switches and the Circuit Breakers used in the RMU shall be of SF₆ insulated and vacuum interrupter type.

In addition, each RMU shall be equipped with all necessary connectors, terminal blocks, and other accessories that will allow the RTU it will house to send required RMU/distribution network indications and measurements to the DAS via the communications system.

1. General Requirements

Each RMU shall include its own power supply, including battery and battery charger, and provisions for supplying a stable source of power for the RTU and radio to be housed by the RMU. Thus, the RMU shall also provide the necessary space for housing the RTU and radio. In addition, space must be provided for the RMU's auxiliary power transformer, which shall serve as the power supply's 230 V AC input, along with all other RMU devices such as the PTs and CTs for deriving voltage and current signals.

Within this context, the general requirements of the RMU shall include, but shall not be limited to provision of the following monitoring and control features:

- Positions of local/remote switches as used to control local and remote access to circuitbreakers and load break switches
- Power supply indications including battery failure and voltage alarms
- Open/closed position of load break switches, circuit breakers, and earthing switches
- Enclosure door-open indications
- SF₆ gas-pressure low alarm
- Circuit breaker and load break switch spring charge (switch readiness) indications
- Circuit breaker relay indications
- Indications of fault current in the RMU's main feeder circuit as detected by the FPI
- Measurement of 11 kV voltage, current, power, energy, and power factor values
- Load break switch and circuit breaker open/close control
- FPI reset control
- Relay settings control

Commissioning of the RMUs shall not be complete until they have been demonstrated on a point-to-point basis to be fully interoperable with the DAS.

2. Parameter Requirements

The RMUs shall be suitable for main cable networks of 630 Amps and loop cable networks of 400 Amps. The minimum design parameters to which their major components shall conform or exceed are summarized in the following tables.

Table 3-1: System Parameters

Parameter	Value
Nominal System Voltage	11 kV
Highest System Voltage	12 kV
Rated Voltage	12 kV
System frequency	50 Hz
Number of Phases	3 Phase/3 Wire

Table 3-2: Circuit Breaker Parameters

Parameter	Value
Lightning Impulse Withstand Voltage Phase-to-Phase & Phase-to-Earth: Across Isolating Distance:	75 kV (peak) 85 kV (peak)
Power Frequency Withstand Voltage to Earth, Between Poles, & Across Opening Span Across Isolating Distance	28 kV rms for 1 minute 32 kV rms for 1 minute
Rated Short Time Withstand/Breaking Current:	20 kA (rms)
Rated Duration of Short Circuit:	3 seconds
Rated Normal Current:	400 Amps (rms)

Table 3-3: Load Break Switch Parameters

Parameter	Value
Rated Short Circuit Making Capacity	50 kA peak at rated voltage (both LBS & Earthing Switch)
Rated Load Interrupting Current	630 Amps
Rated Cable Charging Interrupting Current	25 Amps

The RMU switchgear shall be capable of withstanding the specified currents without damage in accordance with the latest versions of IEC 60694 (Common Specifications

for High-Voltage Switchgear and Control Gear Standards) and IS 3427 (AC Metal Enclosed Switchgear and Control Gear for Rated Voltages above 1 kV and up to and including 52 kV).

2.1 Design Details

- The RMU shall be designed to operate at the rated voltage of 12 kV. It shall consist of two (2) numbers of 630 Amp SF₆ insulated Load Break Switches as incomers and up to three (3) numbers of 400 Amp SF₆ insulated Circuit Breakers.
- It shall include, within the same metal enclosure, earthing switches for each Load Break Switch and Circuit Breaker.
- Suitable fool-proof interlocks shall be provided to the earthing switches to prevent inadvertent or accidental closing when the circuit is live and the concerned Load Break Switch/Circuit Breaker is in its closed position.
- Cast-resin enclosures filled with gas at suitable pressure to ensure adequate insulation and safe operation shall be used. The assembly shall not require further gas processing during its expected operational life of 30 years as per Clause GG 2.3 and 3.3 of IS 3427.
- The degree of protection required against prevailing environmental conditions, including splashing water and dust, shall be not less than IP 54 as per IS 12063.
- The active parts of the switchgear shall be maintenance free. Otherwise, the RMU shall be of low-maintenance type.
- The tank shall be made of an adequate thickness of stainless steel or metallised cast resin and shall be internally arc tested.
- The RMU shall be suitable for mounting on its connecting cable trench.
- For each RMU enclosure, a suitably sized nameplate clearly identifying the enclosure and the electrical characteristics of the enclosed devices shall be provided.
- The positions of the different devices shall be clearly visible to an operator when standing in front of each enclosure with its door open. Device operations shall be clearly visible.
- The RMU design shall be such that access to live parts shall not be possible without the use of Constructor-supplied tools.
- The design shall incorporate features that prevent any accidental opening of the earth switch when it is in the closed position. Similarly, accidental closing of a Circuit Breaker or Load Break Switch shall be prevented when the same is in an

open position. This includes protection against accidental closing resulting from the release of any latch or spring in tension due to vibrations caused externally or internally.

2.2 Earthing

- There shall be continuity between metallic parts of the RMUs and cables so that there is no dangerous electric field in the surrounding air and the safety of personnel is ensured.
- The RMU frames shall be connected to the main earth bars, and the cables shall be earthed by an Earthing Switch having the specified short circuit making capacity.
- The Earthing Switch shall be operable only when the main switch is open. In this respect, a suitable mechanical fail-proof interlock shall be provided.
- The Earthing Switch shall be provided with a reliable earthing terminal for connection to an earthing conductor having a clamping screw suitable for the specified earth fault conditions. The connection point shall be marked with the earth symbol. The flexible connections between the earthing blade and the frame shall have a cross-section of at least 50mm² copper or equivalent in aluminum.
- The Earthing Switch shall be fitted with its own operating mechanism. In this respect, manual closing shall be driven by a fast-acting mechanism independent of the operator's action.

2.3 Incomer Load Break Switches

- The Load Break Switches shall be maintenance free. With enclosure doors open, the position of power contacts and earthing contacts shall be clearly visible from the front of the RMU.
- The position indicator shall provide positive contact indication in accordance with IS 9920. In addition, the manufacturer shall prove the reliability of indication in accordance with IS 9921. These switches shall have three positions (or states), i.e., Open, Closed, and Earthed, and shall be constructed in such a way that natural interlocking prevents unauthorized operations.
- The switches shall be fully assembled, tested, and inspected in the factory.
- Manual opening and closing shall be driven by a fast-acting mechanism independent of manual operator action.
- The Load Break Switches shall be provided with a motorized operating mechanism suitable for SCADA control.
- A facility shall be provided with an electrical operating mechanism allowing an

operator at the RMU site to operate the Load Break Switches without any modification of the operating mechanism and without de-energizing the RMU.

- The switch and earthing switch mechanisms shall have a mechanical endurance of at least 5,000 operations. Otherwise, these mechanisms shall conform to IS 9920 (High Voltage Switches Part 1: High Voltage Switches for Rated Voltages above 1 kV and less than 52 kV).

2.4 Circuit Breakers

The Circuit Breakers shall be maintenance free and, when standing in front of the RMU with enclosure doors open, their positions shall be clearly visible. The position indicator shall provide positive contact indication in accordance with IS 9920. In addition, the manufacturer shall prove the reliability of indication in accordance with IS 9921: Alternating Current Disconnectors (Isolators) and Earthing Switches for Voltages above 1,000 V.

The breakers shall have three positions (or states), i.e., Open, Closed, and Earthed, and shall be constructed in such a way that natural interlocking prevents unauthorized operations. They shall be fully assembled, tested, and inspected in the factory.

An operating mechanism shall be used to manually close the Circuit Breaker and charge the mechanism in a single movement. It shall be fitted with a local system for manual tripping. There shall be no automatic reclosing. The Circuit Breaker shall be capable of closing fully and latching against the rated making current. Mechanical indication of the OPEN, CLOSED, and EARTHED positions of the Circuit Breaker shall be provided.

When the Circuit Breaker closing mechanism is of the spring-operated type, it shall not be possible for the Circuit Breaker to close until the spring is fully charged and the associated charging mechanism is fully ready for closing. Wherever an external spring charging handle is required to charge the spring, it shall be ensured that the same is not allowed to move during release of the spring energy. Alternatively, it shall not be possible to release the spring energy until the charging handle is completely disengaged from the mechanism. A visual mechanical indicating device shall be provided to indicate the status of the spring, i.e., SPRING CHARGED or SPRING FREE. It shall be possible to charge the spring when the Circuit Breaker is closed and, if the spring is released, the Circuit Breaker shall not open. Nor shall this operation result in any mechanical damage to the component of the Circuit Breaker or its operating mechanism. Alternatively, a fast-acting reflex mechanism for Circuit Breakers is also acceptable.

Each Circuit Breaker shall operate in conjunction with a suitable protection relay under lateral circuit phase and earth fault conditions. In addition, the Circuit Breaker shall be

provided with a motorized operating mechanism that can be remotely controlled by the DAS.

2.5 Cable Termination

Bushings shall be conveniently located for working with the specified cables and shall allow for the termination of these cables in accordance with the prevailing practice and guidelines of cable manufacturers. The dimensions of the terminals shall be in accordance with IS 10601.

A non-ferro-magnetic cable clamp arrangement shall be provided for each cable to be terminated in the RMU. Special clamps to avoid mechanical load of the terminated cable on the bushing.

A suitable arrangement for the Circuit Breakers, Earthing Switches, and Load Break Switches shall be provided so that these devices can be padlocked in the "Open" and "Closed" positions.

A permanent "Live Cable" indication as per IEC 61958 (High-Voltage Prefabricated Switchgear and Control Gear Assemblies - Voltage Presence Indicating Systems) shall be provided for each cable using a capacitor voltage divider.

It shall be possible to test the core or sheath insulation of the cables without de-energizing the remaining section of the RMU, accessing the cable compartment, or disconnecting the cable.

2.6 Safety of Equipment

With respect to the RMU's SF₆-filled equipment, any accidental overpressure inside the sealed chamber shall be limited by the opening of a pressure-limiting device in the enclosure so that the gas will be released away from the operator without endangering the operator or anyone else in the vicinity of the RMU.

All manual operations shall be carried out from the front of the RMU. The effort required to be exerted on the lever as used by the operator shall not exceed 250 N.

2.7 Front Plate

The front plate shall include a clear mimic diagram indicating RMU functionality. The position indicators shall correctly depict the position of the main contacts and shall be clearly visible to the operator. The lever operating direction shall be clearly indicated.

3. Line sensors

The RMU shall be provided with current sensors and voltage sensors. These sensors shall meet the electrical and mechanical ratings as per the relevant standards referenced in Table 1-1.

3.1 Current Sensors

A panel shall be provided in each load break switch enclosure to mount a three-phase, single-core, CT for metering purposes. A similar panel shall be provided in each circuit breaker enclosure to mount a three-phase, single-core, CT for protection purposes. CT access for maintenance or any other purpose shall be from the front, back, or top of these panels.

The CTs shall conform to IS 2705. The design and construction shall be sufficiently robust to withstand thermal and dynamic stresses during short circuits. Secondary terminals of CTs shall be brought out suitably to a terminal block, which will be easily accessible for testing and terminal connections.

Further characteristics and features distinguishing CTs used for metering from CTs used for protection are listed as follows:

CTs for Metering:

- Material: Epoxy resin cast
- Burden: 2.5VA
- Ratio: 400-200/1 A
- Accuracy Class: 0.5

CTs for Protection:

- Material: Epoxy resin cast
- Burden: 2.5VA
- Ratio: 200-100/1 A
- Accuracy Class: 5 P 10

The RMU's other CTs, i.e., those used by Fault Passage Indicators (FPIs), shall be supplied by the FPI manufacturer. These CTs shall be an integral part of the FPI's design to ensure that they properly match the requirements of the FPI.

3.2 Voltage Sensors

Three (3) potential transformers shall be provided. The burden per transformer shall be no more than 50 VA and the voltage ratio shall be 11000/110 V. The accuracy class shall be 0.5. HRC fuses shall be provided on the HV side.

The PTs shall be of cast epoxy-resin construction, and they shall conform to IS 3156. Their design and construction, in particular, shall be sufficiently robust to withstand the thermal and dynamic stresses during short circuits.

4. Fault Passage Indicator

Each RMU shall be outfitted with one non-communicable FPI. The FPI shall be mounted in the nominal outgoing OD (Load Break Switch) enclosure along with its integral CT for phase and earth fault monitoring.

The FPIs shall include:

- Fault indicator units for feeder phase and earth faults.
- Potential-free output contacts for hardwiring to RTUs. On this basis, the DAS will be able to monitor fault passage indications. Two such output contacts per FPI are desirable, one for phase and one for earth fault monitoring.
- Potential-free input contacts for hardwiring to RTUs to allow the DAS to reset FPI's following their detection of phase or earth faults.
- Configuration ports for configuring the equipment in the field. Such ports are desirable, but not mandatory.

Local fault indications shall be provided in addition to remote indications through the RTU. The local indications shall use LEDs on the front panel of the RMU enclosure.

The characteristics of the FPIs shall include:

- Phase fault thresholds configurable from at least 100 to 600 A
- Earth fault thresholds configurable from at least 20 to 100 A
- Number of steps for adjusting phase and earth fault thresholds at least four
- Fault current duration range configurable from at least 40 ms to 500 ms
- Protection Relay

The RMU shall be equipped with numerical relays as used to trip the RMU circuit breakers.

4.1 General

The Circuit Breaker enclosures in the RMU shall be outfitted with a communicable-type numerical (feeder protection) relay, i.e., one for each outgoing circuit breaker. The protection relay's auxiliary contacts shall be hardwired to the RTU. The relay shall also interface with the RTU via an RS 232/485 port in order to send, as a minimum, real-time phase current readings using the MODBUS protocol.

The numerical relay shall be powered by the RMU's power supply unit and be provided with Inverse Definite Minimum Time (IDMT) and Instantaneous protection characteristics. On this basis, the relay as a minimum shall provide:

- Phase Overcurrent Protection (50/51)
- Earth Fault Protection (50N/51N)

The feeder protection relay shall be provided with an input for remote tripping, which shall be realized via an electric output pulse even without presence of phase current. A flag indicator shall be installed for signaling the occurrence of trip conditions.

4.2 Features and Characteristics

The numerical relay shall have the following minimal features and characteristics noting that variations may be acceptable as long as they provide similar or better functionality and/or flexibility:

- It shall be housed in a flush mounting case and powered by the RMU power supply unit.
- The Relays shall be of 24V DC auxiliary type.
- It shall have three phase overcurrent elements and one earth fault element.
- IDMT trip current settings shall be 20-200% in steps of 1% for phase overcurrent and 10- 80% in steps of 1% for earth fault.
- Instantaneous trip current settings shall be 100-3000% in steps of 100% for phase overcurrent and 100-1200% in steps of 100% for earth fault.
- Selectable IDMT curves shall be provided to include, for example, Normal Inverse, Very Inverse, Extreme Inverse, Long Time Inverse, and Definite Time. Separate curve settings for phase overcurrent and earth fault shall be supported.
- For IDMT delay multiplication, the Time Multiplier Setting (TMS) shall be adjustable from 0.01 to 0.1 in 0.1 steps.
- The relay shall have local independent LED indications for Healthy, Trip, I>, I>>, IN>, and IN>> conditions.
- The relay shall also be provided with:
 - Alphanumeric Liquid Crystal Display (LCD) for measurement and relay setting.

- Communications via a MODBUS RS232/RS485 port to provide the RTU (and hence the DAS) with phase current measurements. It is also desirable that this same means of communication can be used by the RTU to send setting and control commands to the relay.
- Front USB port for local communications with a laptop PC.
- Parameter change capability that is password protected.
- Capability to record up to 5 of the latest fault records duly time stamped and stored in non-volatile memory for subsequent reading via the above referenced USB port.

5. Power Supply

Each RMU shall be outfitted with a power supply, including batteries and battery charger, suitable for operation of a 5-way RMU even if the RMU, for example, is only 3-way. This is to allow for the possible addition of future automated VLs. On this basis, the following operational specifications shall apply:

- The power supply unit shall conform to the following requirements:
 - Input: 230 V AC nominal from the RMU's auxiliary power transformer allowing for possible variations from 190 to 300 V AC
 - Output: Stable 24 V DC and 12 V DC
 - Batteries: 24 V DC and 12 V DC
 - Receptacles: 2 x 230 V AC (for test equipment)
 - Lighting Fixtures: One for each enclosure
- The auxiliary power transformer's inputs shall be equipped with surge protection devices in accordance with IEC 62305.
- The 24 V DC batteries shall have sufficient capacity to supply power to the following devices with a nominal backup of 4 hours:
 - RMU's spring-charge motors for a minimum of six (6) operations
 - RMU's trip coils, close coils, FPI, multifunction meters, and relays
 - RTU as supplied by others
- The 12 V DC batteries shall have sufficient capacity to supply power to the radio (as supplied by others) with a nominal backup of 8 hours.
- The batteries shall be of sealed lead acid VRLA or dry type and shall have a minimum life of five (5) years at 25°C.
- The battery charger shall be fully temperature compensated.
- To prevent deep discharge of the batteries on loss of AC power source, the battery charger shall automatically disconnect all circuitry fed by the batteries following a user-adjustable time period or when the battery voltage falls below a preset value. If the battery voltage falls below the preset value, the time to fully recharge all batteries shall not exceed twenty-four (24) hours.
- An automatic battery checking device shall be provided to check the battery's health and initiate a battery-failed alarm signal in case battery deterioration is detected. Such detection may be based on comparing measurement values with set values (e.g., internal resistance, voltage, etc.).
- The battery charger shall be provided with an alarm displayed at the local control panel and remotely at the DAS to account for any of the following

conditions:

- Low battery voltage
- High battery voltage
- Battery failed
- Battery charger overvoltage
- Grounded battery/battery-charger
- Others according to manufacturer's design

6. Multi-Function Meter

The RMU main incoming and outgoing OD circuits shall be equipped with Intelligent Electronic Devices (IEDs) in the form of communicable multi-function meters capable of providing distribution system voltage, current, power factor, power, and energy readings.

6.1 Operational Features

The multi-function meters shall have an accuracy class of 0.5 and shall provide data on an RS 232/485 communications port using the MODBUS protocol.

Each multifunction meter shall have the following minimum features:

- It shall be housed in a flush mounting case & powered by the RMU DC power supply unit.
- Measurement, display, and communications capability of up to 31 parameters
- THD measurement and power quality data
- True rms measurement
- Digital communications
- Fully programmable PT and CT ratios
- Simple menu driven interface
- High quality LED display
- Able to monitor:
 - Voltage: line-to-line and line-to-neutral
 - Current: phase and neutral
 - Frequency
 - Power factor
 - Power (active, apparent, and reactive)
 - Energy (active and reactive)
 - Total harmonic distortion

6.2 Specifications

The following table summarizes the specifications applicable to the multi-function meter.

Table 3-4: Multi-Function Meter Specifications

Parameter	Value
Input Voltage: Nominal input voltage (AC rms) Max continuous input voltage	57.7 – 277 V L-N, 100 - 480 V L-L 120% of nominal value
Input Current: Nominal input current System CT primary values Max continuous input current	1 or 5A AC rms (programmable on site) Standard values up to 4 kA (1 or 5 A) 120% of rated value
Overload Withstand: Voltage Current	2 x rated for 1 sec, repeated 10 times at 10 sec intervals 20 x rated for 1 sec, repeated 5 times at 5 minutes
Operating Measuring Ranges	5 to 120% of rated value
Current	5 to 120% of rated value
Frequency	40 to 70 Hz
Power Factor	0.5 lag to 0.8 lead
Accuracy Reference Conditions: Reference temperature Input waveform Input frequency Auxiliary supply voltage Auxiliary supply frequency Power Factor	23°C ± 2°C Sinusoidal (distortion factor 0.005) 50 or 60 Hz ±2% Rated Value ±1% Rated Value ±1% 0.866 lag to 0.866 lead
Accuracy: Voltage Current Frequency Active Power Re-Active Power Apparent Power Active Energy (kWh) Reactive Energy (kVArh) Apparent Energy (kVAh) Phase Angle and Power Factor	±0.5% over 50 to 100% of rated value ±0.5% over 10 to 100% of rated value 0.15% at mid frequency ±0.5% over 10 to 100% of rated value ±0.5% over 10 to 100% of rated value ±0.5% over 10 to 100% of rated value 1% (IEC 62053-21) from 0.866 lag to 0.866 lead 1% (IEC 62053-21) from 0.866 lag to 0.866 lead 1% 1 %
Applicable Standards: EMC Immunity Safety IP for water and dust	IEC 61326 IEC 61000-4-3 (10V/m minimum, Level 3) IEC 61010-1-2001 (permanently connected use) IEC 60529
Environmental: Operating temperature Relative humidity	-10 to +55°C 0 to 90% non-condensing

7. Distribution Automation System Interface

The RMU shall be equipped so that it can be monitored and controlled via the DAS. In this respect, it shall interoperate with the RTU that will be housed in the RMU Control Cabinet. The RTU in turn will interoperate with the DAS via the remote radio and the communications system to which the radio is linked.

The RMU shall have provisions for opening and closing its switches using output from the RTU. The RMU shall also supply analog and status signals to the RTU for monitoring the condition of the RMU's distribution network circuits as well as the components of the RMU. A list of input/output points required for 3-way and 5-way RMU configurations is presented in Table 3-5 below.

Table 3-5: Data Points per RMU Configuration

3-Way RMU

DIGITA LINPUT	CONTROL OUTPUT	IED DAT A
<p><u>LBS 1</u></p> <ul style="list-style-type: none"> ▪ LBS 1: closed ▪ LBS 1: open ▪ Spring 1: charged ▪ Earth switch 1: closed ▪ Earth switch 1: open ▪ LBS 1: local/remote status ▪ Door: open <p><u>LBS 2</u></p> <ul style="list-style-type: none"> ▪ LBS 2: closed ▪ LBS 2: open ▪ Spring 2: charged ▪ Earth switch 2: closed ▪ Earth switch 2: open ▪ LBS 2: local/remote status ▪ Door: open <p><u>FPI</u> (assuming 2 contacts)</p> <ul style="list-style-type: none"> ▪ Overcurrent operated ▪ Earth fault operated <p><u>CB1</u></p> <ul style="list-style-type: none"> ▪ CB 1: closed ▪ CB 1: open ▪ Spring 1: charged ▪ Earth switch 1: closed ▪ Earth switch 1: open ▪ Overcurrent relay 1: operated ▪ Earth fault relay 1: operated ▪ CB 1: local/remote status ▪ Door: open <p><u>Miscellaneous</u></p>	<p><u>LBS 1</u></p> <ul style="list-style-type: none"> ▪ LBS 1: close ▪ LBS 1: open <p><u>LBS 2</u></p> <ul style="list-style-type: none"> ▪ LBS 2: close ▪ LBS 2: open <p><u>CB 1</u></p> <ul style="list-style-type: none"> ▪ CB 1: close ▪ CB 1: open <p><u>FPI</u></p> <ul style="list-style-type: none"> ▪ Reset <p>Total (with spare): 8</p>	<p><u>Multifunction Meter</u> Communication on MODBUS through RS-232/485 ports (2 meters)</p> <p><u>No. of Measurements:</u></p> <ul style="list-style-type: none"> ▪ Voltage: 6 ▪ Current: 6 ▪ Active power: 6 ▪ Reactive power: 6 ▪ Power factor: 2 ▪ Active Energy: 2 ▪ Reactive Energy: 2 <p>Total Measurements: 30</p> <p><u>Feeder Protection Relay</u> Communication on MODBUS through RS-232/485 ports (One protection relay).</p> <p><u>Minimum No. of Points:</u></p> <ul style="list-style-type: none"> ▪ 3 points per relay <p>Total Points: 3</p>

<p><u>US</u></p> <ul style="list-style-type: none"> ▪ SF₆ Pressure: Low ▪ Charger AC: Fail ▪ Voltage DC: Low ▪ Battery alarms: Battery-failed, etc. <p>Total (with spare): 40</p>		
---	--	--

4-Way RMU

DIGITAL INPUT	CONTROL OUTPUT	IED DATA
<p><u>LBS 1</u></p> <ul style="list-style-type: none"> ▪ LBS 1: closed ▪ LBS 1: open ▪ Spring 1: charged ▪ Earth switch 1: closed ▪ Earth switch 1: open ▪ LBS 1: local/remote status ▪ Door: open <p><u>LBS 2</u></p> <ul style="list-style-type: none"> ▪ LBS 2: closed ▪ LBS 2: open ▪ Spring 2: charged ▪ Earth switch 2: closed ▪ Earth switch 2: open ▪ LBS 2: local/remote status ▪ Door: open <p><u>FPI (assuming 2 contacts)</u></p> <ul style="list-style-type: none"> ▪ Overcurrent operated ▪ Earth fault operated <p><u>CB1</u></p> <ul style="list-style-type: none"> ▪ CB 1: closed ▪ CB 1: open ▪ Spring 1: charged ▪ Earth switch 1: closed ▪ Earth switch 1: open ▪ Overcurrent relay 1: operated ▪ Earth fault relay 1: operated ▪ CB 1: local/remote status ▪ Door: open <p><u>CB2</u></p> <ul style="list-style-type: none"> ▪ CB 2: closed ▪ CB 2: open ▪ Spring 2: charged ▪ Earth switch 2: closed ▪ Earth switch 2: open ▪ Overcurrent relay 2: operated ▪ Earth fault relay 2: operated ▪ CB 2: local/remote status ▪ Door: open <p><u>Miscellaneous</u></p> <ul style="list-style-type: none"> ▪ SF₆ Pressure: Low ▪ Charger AC: Fail ▪ Voltage DC: Low ▪ Battery alarms: Battery-failed, etc. <p>Total (with spare): 47</p>	<p><u>LBS 1</u></p> <ul style="list-style-type: none"> ▪ LBS 1: close ▪ LBS 1: open <p><u>LBS 2</u></p> <ul style="list-style-type: none"> ▪ LBS 2: close ▪ LBS 2: open <p><u>CB 1</u></p> <ul style="list-style-type: none"> ▪ <u>CB 1: close</u> ▪ <u>CB 1: open</u> <p><u>CB 2</u></p> <ul style="list-style-type: none"> ▪ CB 2: close ▪ CB 2: open <p><u>CB 3</u></p> <ul style="list-style-type: none"> ▪ CB 3: close ▪ CB 3: open <p><u>FPI</u></p> <ul style="list-style-type: none"> ▪ Reset <p>Total (with spare): 16</p>	<p><u>Multifunction Meter Communication on MODBUS through RS-232/485 ports (2 meters)</u></p> <p><u>No. of Measurements:</u></p> <ul style="list-style-type: none"> ▪ Voltage: 6 ▪ Current: 6 ▪ Active power: 6 ▪ Reactive power: 6 ▪ Power factor: 2 ▪ Active Energy: 2 ▪ Reactive Energy: 2 <p>Total Measurements: 30</p> <p><u>Feeder Protection Relay Communication on MODBUS through RS-232/485 ports (3 protection relays).</u></p> <p><u>Minimum No. of Points:</u></p> <ul style="list-style-type: none"> ▪ 3 points per relay <p>Total Points: 9</p>

5-Way RMU

DIGITAL INPUT	CONTROL OUTPUT	IED DATA
<p><u>LBS 1</u></p> <ul style="list-style-type: none"> ▪ <u>LBS 1: closed</u> ▪ <u>LBS 1: open</u> ▪ <u>Spring 1: charged</u> ▪ <u>Earth switch 1: closed</u> ▪ <u>Earth switch 1: open</u> ▪ <u>LBS 1: local/remote status</u> ▪ <u>Door: open</u> <p><u>LBS 2</u></p> <ul style="list-style-type: none"> ▪ <u>LBS 2: closed</u> ▪ <u>LBS 2: open</u> ▪ <u>Spring 2: charged</u> ▪ <u>Earth switch 2: closed</u> ▪ <u>Earth switch 2: open</u> ▪ <u>LBS 2: local/remote status</u> ▪ <u>Door: open</u> <p><u>FPI (assuming 2 contacts)</u></p> <ul style="list-style-type: none"> ▪ <u>Overcurrent operated</u> ▪ <u>Earth fault operated</u> <p><u>CB1</u></p> <ul style="list-style-type: none"> ▪ <u>CB 1: closed</u> ▪ <u>CB 1: open</u> ▪ <u>Spring 1: charged</u> ▪ <u>Earth switch 1: closed</u> ▪ <u>Earth switch 1: open</u> ▪ <u>Overcurrent relay 1: operated</u> ▪ <u>Earth fault relay 1: operated</u> ▪ <u>CB 1: local/remote status</u> ▪ <u>Door: open</u> <p><u>CB2</u></p> <ul style="list-style-type: none"> ▪ <u>CB 2: closed</u> ▪ <u>CB 2: open</u> ▪ <u>Spring 2: charged</u> ▪ <u>Earth switch 2: closed</u> ▪ <u>Earth switch 2: open</u> ▪ <u>Overcurrent relay 2: operated</u> ▪ <u>Earth fault relay 2: operated</u> ▪ <u>CB 2: local/remote status</u> ▪ <u>Door: open</u> <p><u>CB3</u></p> <ul style="list-style-type: none"> ▪ <u>CB 3: closed</u> ▪ <u>CB 3: open</u> ▪ <u>Spring 3: charged</u> ▪ <u>Earth switch 3: closed</u> ▪ <u>Earth switch 3: open</u> ▪ <u>Overcurrent relay 3: operated</u> ▪ <u>Earth fault relay 3: operated</u> ▪ <u>CB 3: local/remote status</u> ▪ <u>Door: open</u> <p><u>Miscellaneous</u></p> <ul style="list-style-type: none"> ▪ <u>SF6 Pressure: Low</u> ▪ <u>Charger AC: Fail</u> ▪ <u>Voltage DC: Low</u> ▪ <u>Battery alarms: Battery-failed, etc.</u> <p>Total (with spare): 56</p>	<p><u>LBS 1</u></p> <ul style="list-style-type: none"> ▪ <u>LBS 1: close</u> ▪ <u>LBS 1: open</u> <p><u>LBS 2</u></p> <ul style="list-style-type: none"> ▪ <u>LBS 2: close</u> ▪ <u>LBS 2: open</u> <p><u>CB 1</u></p> <ul style="list-style-type: none"> ▪ <u>CB 1: close</u> ▪ <u>CB 1: open</u> <p><u>CB 2</u></p> <ul style="list-style-type: none"> ▪ <u>CB 2: close</u> ▪ <u>CB 2: open</u> <p><u>CB 3</u></p> <ul style="list-style-type: none"> ▪ <u>CB 3: close</u> ▪ <u>CB 3: open</u> <p><u>FPI</u></p> <ul style="list-style-type: none"> ▪ <u>Reset</u> <p>Total (with spare): 16</p>	<p><u>Multifunction Meter</u> <u>Communication on MODBUS</u> <u>through RS-232/485 ports (2 meters)</u></p> <p><u>No. of Measurements:</u></p> <ul style="list-style-type: none"> ▪ <u>Voltage: 6</u> ▪ <u>Current: 6</u> ▪ <u>Active power: 6</u> ▪ <u>Reactive power: 6</u> ▪ <u>Power factor: 2</u> ▪ <u>Active Energy: 2</u> ▪ <u>Reactive Energy: 2</u> <p>Total Measurements: 30</p> <p><u>Feeder Protection Relay</u> <u>Communication on MODBUS</u> <u>through RS-232/485 ports (3 protection relays).</u></p> <p><u>Minimum No. of Points:</u></p> <ul style="list-style-type: none"> ▪ <u>3 points per relay</u> <p>Total Points: 9</p>

7.1 Multi-Function Meter Interface with RTU

The Contractor is required to furnish the RMU meter information that pertains to interfacing the meter with the RTU through an RS 232/485 serial communications link. The protocol details along with the MODBUS mapping data as implemented in each meter shall be provided. In this respect, the Contractor in cooperation and coordination with the RTU contractor shall share the responsibility of ensuring effective communications is attained between the meter and RTU, i.e., all parameters read by the meters shall also be immediately available to the RTU.

7.2 Numerical Relay Interface with RTU

The Contractor is required to furnish the numerical relay information that pertains to interfacing the relay with the RTU through an RS 232/485 serial communications link. The protocol details along with the MODBUS mapping data as implemented in each relay shall be provided. In this respect, the Contractor in cooperation and coordination with the RTU contractor shall share the responsibility of ensuring effective communications is attained between the relay and RTU, i.e., all parameters read by the relay shall also be immediately available to the RTU.

8. Construction

The RMU shall be sufficiently sturdy to withstand handling during shipment, installation, and start-up without damage. The configuration for shipment shall adequately protect the RMU equipment from scraping, banging, or any other damage. The Contractor shall assume responsibility for correction of all such damage prior to final acceptance of the equipment.

9. Enclosures

All Contractor-supplied enclosures shall be sized to provide convenient access to all enclosed components. It shall not be necessary to remove any component to gain access to another component for maintenance purposes or any other reason.

The enclosures shall also be designed to ensure that the enclosure remains rigid and retains its structural integrity under all operating and service conditions with and without the enclosure door closed.

If made from stainless steel (304L or 316L), the thickness of the enclosure panels shall be at least 1.5 mm. Otherwise the thickness of all enclosure panels shall be at least 2 mm.

The appropriate corrosion treatment and finish requirements of Clause 2.2.2 shall apply to both inside and outside enclosure surfaces. Other required features are as follows:

- Constructed of stainless steel (304L or 316L) according to IEC 60529 with IP rating 54 or better. Alternatively, the RMU metal parts shall be made of high thickness high tensile steel which must be grit/shot blasted, thermally sprayed with Zinc alloy, phosphate, and subsequently painted with polyurethane based powder paint, the overall paint layer thickness including Zinc spraying shall be of the order of 100 to 130 microns.
- Means, such as insulated heat shields and/or air vents, to prevent high temperatures from damaging the RMUs enclosed components. If air vents are installed, these vents shall in no way reduce the effectiveness of the enclosure's protective characteristics.
- A metal pocket attached to the inside of the front door to hold documentation, maintenance log sheets, and other such information.
- Door opening mechanism with built-in key-lock facility suitable for padlocking. An opening mechanism that is less prone to breaking than a projecting door handle is preferred, e.g., a push-button opening mechanism.
- A grounding terminal including grounding bolt and lock washer for connecting a 50 mm² galvanized steel grounding conductor. The grounding bolt and lock washer shall be made of stainless steel.
- Means of preventing moisture from condensing on electronic components mounted inside the enclosure proposed for housing the RTU. If necessary, heaters providing adjustable thermostat-control within the range 20 to 60 °C shall be installed in the enclosure for this purpose.
- Means of protection against rain water, corrosive salt formations, and high levels of airborne dust.
- Means of enabling the DAS to monitor the open/closed status of the enclosure door. A DAS equipment alarm shall be produced whenever the enclosure door is open.

10. Control Cabinet

The RMU shall be outfitted with a separate enclosure, referred to herein as the Control Cabinet, to house the following equipment as a minimum:

- Auxiliary transformer
- SCADA terminal blocks

- Power Supply Unit including Charger and Batteries
- RTU
- Radio (supplied and installed by others)
- Multi-pin connector consisting of plug and socket fittings and angled terminal block
- Other equipment according to manufacturer's design

The Control Cabinet shall be similar in style and finish as the other RMU enclosures. This shall include having a minimum protection class of IP 54. It shall be tested in accordance with the latest IEC 60529 standard.

The cabinet shall have a hinged front access door with a three-point latch locking system and a latch operating lockable handle. The door shall be fitted with a perimeter flange and gasket (rubber or neoprene) to prevent the entrance of water. In addition, a means of monitoring and indicating that the door is open shall be provided.

A metal screen with holes shall be provided on the top and bottom of the control cabinet to provide ventilation aimed at avoiding condensation inside. Venting however shall in no way reduce the effectiveness of the control cabinet's water-tight, dust-tight, and corrosion-resistant characteristics. To augment the cabinet's effectiveness in preventing the ingress of dust, insects, vermin, and small objects, all electronic parts within the control cabinet shall be enclosed in modules. Such parts and modules shall be separated from the power supply modules as also installed in the cabinet.

The Control Cabinet shall include a weather-sealed hole with a double compression cable gland, approximately 30 mm in diameter, on the top of the cabinet for routing an antenna cable that will be supplied and installed by BESCO. This will enable the cable to connect the radio housed in the cabinet to its externally mounted antenna. To house the radio, and the RTU to be supplied and installed by BESCO, the Control Cabinet shall include a minimum contiguous space of 600 mm (W) x 500mm (D) x 600 mm (H).

If made from stainless steel (304L or 316L), the thickness of the enclosure panels shall be at least 1.5 mm. Otherwise the thickness of all enclosure panels shall be at least 2 mm.

The control cabinet shall also be provided with:

- Weatherproof fittings for control cables.
- **Provision for handle and padlock. In addition to this, a Metal number lock of adequate size shall be provided.**
- Grounding terminal, with solderless clamp type connector suitable for steel

stranded conductor of suitable diameter and complete with lock washer of stainless steel or better.

- Provision for separately grounding the RMU's electronic items.
- Thermally controlled small fan for circulating air when necessary to maintain temperatures within the Control Cabinet to acceptable levels.
- Circuit diagram of control unit for maintenance purpose affixed permanently.
- Others according to manufacturer's design.

11. Auxiliary Transformer

The RMU shall be outfitted with a single-phase auxiliary power transformer with a turns ratio of 11000/sqrt (3) to 230, i.e., it shall be connected line-to-neutral to the RMU 11 kV bus and used to provide the required 230 V AC input to the RMU's power supply. The auxiliary power transformer shall have a capacity of at least 1,000 VA. During project implementation, however, the Contractor shall assess this requirement by taking into account the actual load corresponding to the RTU and radio (supplied by others) as well as the load represented by the RMU motors, etc. In this respect, with a suitable margin approved by the Employer, the auxiliary transformer must be capable of supporting the power supply requirements that correspond to a 5-way RMU. HRC fuses shall be provided on both the HV and LV sides of the transformer.

12. Motors

The RMU shall be retro-fitted with spring charge motors of insulation Class E or better allowing the circuit breakers and load break switches to be operated without manual intervention. Motor speed shall ensure springs can be charged within 1 to 2 seconds. Independently of DAS control, the mechanism shall ensure that the motors start up immediately once the spring becomes discharged, so that the breaker becomes ready for the next operation.

In addition to allowing circuit breaker tripping by the RMU's protection relays, the motorized operating mechanism shall be suitable for remote control by the DAS.

The motors along with a Contractor supplied control panel shall allow Employer personnel to electrically operate the circuit breakers and load break switches at site without any modification of the operating mechanism and without de-energizing the RMU.

The motors shall be of a reputable make in the form of a universal 24 V DC type. They shall be enclosed and completely dust proof and sized with a suitable margin to meet the torque requirement of the spring charge mechanism.

13 Inspection and Test

Inspections and tests shall be performed to ensure RMU compliance with these Technical Specifications. Responsibility for conducting the inspections and tests shall rest with the Contractor. The Employer will participate in the RMU inspections and will witness the testing as described in the following sub-clauses.

13.1 Inspections

Employer representatives shall be allowed access to any Contractor or other facility where the RMU or its parts are being produced or tested. Such access will be used to verify by inspection that the RMUs are being or have been fabricated and tested in accordance with the Technical Specifications.

The Contractor shall give the Employer 15 days notice in writing concerning the date and place at which the equipment will be ready for inspection or testing. The Contractor shall provide all the necessary assistance and facilities to Employer representatives to carry such inspections and test witnessing.

The Employer representatives will also visit Employer sites where the RMUs have been delivered and are being or have been installed and tested to ensure the installations and testing are proceeding or have been completed in the manner intended.

The Contractor shall provide any and all documentation that is necessary to complete the inspections. The Employer shall be allowed to inspect the Contractor's quality assurance standards, procedures, and records. Inspections, as a minimum, shall include checks on inventory, general appearance, cabling, drawing conformance, and labeling.

Where applicable, the Employer's inspections will be performed in conjunction with witnessing the RMU tests. The Contractor shall take all necessary steps to address and resolve any concerns that Employer representatives may raise as a result of these activities in a timely fashion.

This may result in further inspections and tests until the representatives are fully satisfied that the inspections and tests have been completed successfully.

13.2 Test Procedures

The Contractor shall provide test plans and detailed procedures for all required testing. The plans and procedures shall ensure that each test is comprehensive and verifies proper performance of the RMU under test and, in this respect, shall be submitted for review and approval by the Employer.

The test plans shall include all routine tests and acceptance tests as per relevant BIS/IEC standards and shall describe the overall test process including the responsibilities of the test personnel and how the test results will be documented.

The test procedures shall describe the individual tests segments and the steps comprising each segment, particularly the methods and processes to be followed.

13.3 Test Reports

The Contractor shall maintain complete records of all test results. The records shall be keyed to the test procedures.

Upon completion of each test, the Contractor shall submit a test report summarizing the tests performed and the results of the tests. The test report shall include the following information:

- 13.1.1 Test Log - A chronological record of all events related to execution of the tests.
- 13.1.2 Test Incident Report – A detailed description of any event during the testing process that required investigation.
- 13.1.3 Test Summary Report – A presentation of results pertaining to the designated test activities and a summary of all relevant recommendations and conclusions based on these results.
- 13.1.4 Variance Report – A summary of the problems detected during testing and the corresponding resolutions.
- 13.1.5 Official Certification – A formal declaration that the required testing was performed and, if applicable, was completed successfully.
- 13.1.6 Signatures – As designated representatives of the Contractor and/or Employer, the signatures of witnesses for each completed test, whether successful or not successful, along with relevant dates. Witness names and contact information shall also be provided.

13.4 Factory Acceptance Test

A formal factory acceptance test shall be conducted to ensure that the RMUs have been designed to meet the Employer's functional requirements in all respects. Employer representatives shall witness the test on a representative RMU, and the test shall be carried out in accordance with the Contractor's test plan and procedures as approved by the Employer. Should the factory acceptance test prove unsatisfactory in any way, the Employer reserves the right to have further tests conducted and, if applicable, request further improvements in the Contractor's RMU design.

To the extent possible, the test shall demonstrate the capability of the RMU to interoperate with the RTU. It is also the intent of the Employer that the test shall make use of the Data Acquisition (DAC) Simulator to be supplied by BESCO. The DAC Simulator (representing the DAS) together with the RTU will reduce the risk of discovering interoperability problems subsequent to RMU installation at site. Thus, in preparation for the factory acceptance test, the Contractor shall make every effort to cooperate and coordinate all such activities with these other contractors.

13.5 Routine Factory Tests

These tests shall be carried out during RMU manufacture as a quality control measure, i.e., to ensure each RMU to be delivered meets the Employer's minimum requirements including all relevant standards. Recording and reporting the routine test results shall be the responsibility of the Contractor.

At the Employer's discretion, Employer representatives will witness such testing. This may include requesting the Contractor to perform tests on RMUs selected at random from each batch of RMUs that the Contractor deems ready to be delivered to site. Should any such test prove unsatisfactory, the Employer reserves the right to have further tests conducted and for delivery not to take place until a mutually agreed course of action has been reached.

13.6 Field Performance Tests

13.6.1 Unit Test

Each and every RMU shall be tested at site. This shall include unit testing by the Contractor at the time of installation of each RMU to ensure all components can be powered up and are in good working order.

13.6.2 Site Acceptance Test

Each RMU shall undergo a Site Acceptance Test (SAT) to demonstrate to the Employer that the RMU is fully operational with respect to its functional capabilities and intended use

at its specifically assigned site. In this respect, site acceptance testing shall be carried out in such a way as to verify that the RTU can be used to monitor and control the site's associated distribution network devices.

Such testing shall be conducted in a way that will minimize power interruptions. Any need for power interruptions in order to conduct the testing shall be arranged in full and timely coordination with the Employer's system operations staff. Otherwise, the functional capabilities shall be exercised using non-outage techniques such as simulating analog and status inputs and checking for control output signals at points of connection that may need to be temporarily isolated from the distribution network.

During SAT, it shall be demonstrated that the RMU and RTU can interoperate successfully in all respects. To this end, the intent is to make use further use of the DAC Simulator to be provided by the DAS supplier. Thus SAT shall verify that the RMU interface is fully operational and capable of meeting or supporting all applicable DAS functional performance requirements.

13.6.3 RMU Commissioning

The end-to-end tests for RMU operations and communicability features of the relay and meter shall serve as a means of commissioning the RMU. The Contractor, therefore, shall support end-to-end testing by having adequate Contractor personnel on hand to witness these tests in consultation with DAS.

Prior to starting the warranty period, the Contractor shall submit a report clearly identifying the results of all end-to-end tests from the perspective of the RMUs. This shall include a summary of the variances detected and whether or not these variances were successfully corrected. Where necessary, for Employer consideration, the report shall include the Contractor's plan for resolving any and all variances not yet corrected.

No RMU installation shall be accepted as complete until the Employer is satisfied that all variances associated with an individual site have been corrected and that the RMU is SCADA ready, i.e., can be considered fully integrated with the DAS.

Documentation

It is the intent of the Employer to become self-sufficient in all aspects of the field device. In order to assure that the Employer has the opportunity to become self-sufficient in a timely and orderly manner, it is necessary that the Contractor provide high quality documentation.

13.6.4 Equipment Manuals

Equipment manuals shall contain the following:

- 13.6.4.1 Description of the function of the equipment
- 13.6.4.2 Installation, setup, and operating instructions
- 13.6.4.3 Block diagram showing logical and physical interconnections among major components
- 13.6.4.4 Expansion and upgrade capabilities and instructions
- 13.6.4.5 Preventive maintenance instructions
- 13.6.4.6 Detailed functional, logical, electrical, and mechanical characteristics of all equipment including protocol descriptions
- 13.6.4.7 Troubleshooting and repair guides, including descriptions and instructions for the diagnostics furnished

14 Operating Manuals

The Contractor shall submit, for review and approval, operating manuals for all RMU components including items such as FPI, Relay, and MFM. These manuals shall be in English. They shall include the RMU operating instructions. Context sensitivity shall be used to go directly to the appropriate place in the manual.

The manuals shall be organized for quick access to each detailed description of the operator procedures that are required to interact with the RMU functions. This shall include the procedures to define, build, edit, and expand all data points provided with the RMU.

The manuals shall present in a clear and concise manner all information that operators, including maintenance personnel, need to know to understand and operate RMUs satisfactorily. The manuals shall make abundant use of diagrams and/or photographs to illustrate the various procedures involved.

15 As-Built Documents and Drawings

The Contractor shall submit as built documents including applicable drawings for review and approval. All deliverable documents and drawings shall be revised by the Contractor to reflect the as-built RMU components including all the FPI, Relay, and MFM devices. Any errors in or modifications to an RMU resulting from its factory and/or site acceptance test shall be incorporated. Within this same context, all previously submitted documents that are changed because of engineering changes, contract changes, errors, or omissions shall be resubmitted for review and approval.

SECTION – 4

**RMU: COMPACT RMU FOR OUTDOOR USE IN 11KV
DISTRIBUTION CABLE SYSTEM**

**TECHNICAL SPECIFICATION FOR 11 KV COMPACT RING MAIN UNITS FOR OUT DOOR
USE IN 11 KV UNDERGROUND CABLE SYSTEM**

1. SCOPE:

- 1.1 This specification covers the design, manufacture, testing and delivery at site for erection and commissioning of "Compact RMU" to be erected in the underground cable distribution system.
- 1.2 The Compact RMU shall be suitable for main cable network of 800Amps and loop cable network of 800Amps /630Amps and shall consist of the following:
- (a) Two Load Break Switches with Earthing Switches for incoming and outgoing main loop 11 KV XLPE cables of size 240/400 sq.mm cross section aluminum conductor,
 - (b) One Circuit Breaker with Earthing Switch for connecting Distribution Transformer loop 11 KV XLPE cables of size 95 sq.mm cross section aluminium conductor, and
 - (c) Provision for adding more number of Circuit Breakers of the type mentioned in item (b) above.
- 1.3 These shall comply with the following system parameters:

1.	Nominal System Voltage:	11 KV
2.	Highest System Voltage:	12 KV
3.	Rated Voltage:	12 KV
4.	System frequency:	50 Hz
5.	Number of Phases:	Three Phase - Three Wire

- 1.4 The Load Break Switches with Earthing Switches, and the Circuit Breakers with Earth Switches used in the Compact RMU shall be of Vacuum or SF₆ gas filled type meeting the following criteria:

1.	Lightning Impulse Withstand Voltage	
(a)	Phase - to - Phase & Phase - to - Earth:	75 KVp
(b)	Across the Isolating distance:	85 KVp

2.	Power Frequency Withstand Voltage: (1) to earth, between poles and across opening (2) switch device (3) across isolating device	28 KV rms for minute 32 KV rms for 1 minute
3.	Rated Short Time Breaking Capacity	21 KA for 3 sec
4.	Rated duration of Short Circuit:	3 seconds
5.	Rated Normal Current for Circuit Breaker:	200 Amps rms
6	Load Break Switches:	
	a) Rated Short Circuit making capacity:	(a) 50 KA peak at rated voltage (both the earth switch and Load Break Switches)
	b) Rated Load Interrupting Current:	800 Amps / 630 A rms
	c) Rated Cable Charging Interrupting current	25 A

1.5 The configuration of the Compact RMU shall be generally as per BESCO. Provision should be made to extend the Compact RMU by installing additional Circuit Breakers of similar design.

1.6 All the switchgear shall be capable of withstanding the specified current without any damage being caused, in accordance with the latest versions of IEC 60694 and IS 3427.

1.7 Suitable Meter & CT's along with suitable wiring and other accessories shall be provided as per BESCO Metering specifications / norms.

2. SERVICE CONDITIONS:

2.1 The equipment shall be suitable for installation at location having the following climatic conditions:

a	Annual average ambient temperature:	40°C
b	Maximum ambient temperature:	45°C
c	Temperature rise due to solar absorption:	10°C
d	Maximum relative humidity:	95%
e	Annual rainfall:	1000 to 1200 mm
f	Duration of rainy season:	May to October
g	Altitude:	up to 1000 M above MSL
h	Environmental condition:	Exposed to sun and rain by the side of road and subject to dust and Pollution from the heavy vehicular Traffic

3. STANDARDS:

3.1 The equipment's and all the components shall meet the requirements of the latest versions of the following standards:

- (a) IS 3427: AC metal enclosed switchgear and control gear for rated voltages above 1 KV and up to and including 52 KV.
- (b) IS 12063: Classification of degrees of protection provided by enclosures of electrical equipment.
- (c) IS 9920 (Parts 1 to 4): High Voltage Switches.
- (d) IS 9921 (Parts 1 to 5): Specification for AC disconnectors and earthing switches for voltages above 1000 V
- (e) IS 13118: HV AC Circuit Breakers.
- (f) IS 12729: General requirements of switchgear and control gear for voltages exceeding 1000 V
- (g) IS 10601: Dimensions of terminals of HV Switchgear and Control gear.
- (h) IEC 1330: High voltage/Low voltage prefabricated substations
- (i) IEC 60694: Common clauses for MV switchgear standards.
- (j) IEC 6081: Monitoring and control.
- (k) IS 2705: Current Transformers

(l) IS 8686: Specification for Static Protective Relays.

4. DESIGN:

- 4.1 The compact RMU shall be designed to operate at the rated voltage of 12 KV. It shall consist of Two numbers of 630 Amps Vacuum or SF₆ Insulated Load Break Switches as Incomers and the required numbers of 200 Amps Vacuum or SF₆ Circuit Breakers suitable for control of 11 KV Transformer loop circuits consisting of several distribution transformers; total load of which do not exceed 3500 KVA. It shall also include, within the same metal or earth screened cast resin enclosure, earthing switches for each Load Break Switch and Circuit Breaker for earthing each of the devices. Suitable fool-proof interlocks shall be provided to these earthing switches to prevent its inadvertent or accidental closing when the circuit is live and the concerned Load Break Switch/Circuit Breaker is in closed position. The limiting dimensions shall be preferably around 1800-mm width x 1100-mm depth x 1900-mm height for the initial two Load Break Switches and one Circuit Breaker. Suitable width for each addition of the Circuit Breaker is allowed. Provision should be made for extension of few more Circuit Breakers or Load Break Switches on a future date. In case of gas filled units, the switchgear and bus bars shall be contained in stainless steel/earth screened cast resin enclosure filled with gas at relative pressure between 0.2 and 0.8 bar to ensure adequate insulation and safe operation. The assembly should not require further gas processing during its expected life of operation of 30 years as per Clause GG 2.3 and 3.3 of IS 3427. The degree of protection required against environment shall be not less than IPX4 of IS 12063. The Compact RMU shall have at least an IP54 Protection Index as per IS 12063 against dust and splashing of water. The active parts of the switchgear shall be maintenance free and the Compact RMU shall be of low-maintenance type.
- 4.2 The tank shall be made of suitable stainless steel of adequate thickness or earth screened cast iron resin and shall be able to withstand any accidental internal over pressure of at least 3 bars.
- 4.3 The Compact RMU shall be suitable for mounting on its connecting cable trench. A suitably sized name plate clearly indicating its functional units and their electrical characteristics shall identify each unit. The positions of the different devices shall be clearly visible to the operator on the front of the compact RMU and the operations shall be clearly visible. The

compact RMUs shall be such that access to live parts shall not be possible without the use of tools.

- 4.4 The design shall incorporate such features to prevent any accidental opening of the earth switch when it is in closed position. Similarly, accidental closing of Circuit Breaker or Load Break Switch shall be prevented when the same is in open position from the release of any latch or spring in tension due to vibrations caused externally or internally and shall prevent accidents.

5. EARTHING:

- 5.1 There shall be continuity between metallic parts of the Compact RMUs and cables so that there is no dangerous electric field in the surrounding air and safety of the personnel is ensured. The frames should be connected to the main earth bars. The cables should be earthed by an Earthing Switch having the specified short circuit making capacity. The Earthing Switch shall be operable only when the main switch is open and suitable mechanical fail-proof interlock shall be provided for the same.
- 5.2 The Earthing Switch shall be provided with a reliable earthing terminal for connection to an earthing conductor having a clamping screw, suitable for the specified earth fault conditions. The diameter of the clamping screw shall be at least 12 mm. The connection point shall be marked with the earth symbol. The flexible connections between the earthing blade and the frame shall have a cross section of at least 50 square mm copper or equivalent in aluminum.
- 5.3 The Earthing Switch shall be fitted with its own operating mechanism and manual closing shall be driven by a fast-acting mechanism, independent of operator's action. The moving contacts of the Earth Switch shall be visible in the closed position through transparent covers. Mechanical interlocking system shall be such that the operating staff shall be prevented from closing the Earthing Switch when the main switch is closed.

6. INCOMER LOAD BREAK SWITCHES:

- 6.1 The Load Break Switches shall be maintenance free. The position of power contacts and earthing contacts shall be clearly visible on the front of the Compact RMU. The position indicator shall provide positive contact indication in accordance with IS 9920. In addition, the manufacturer shall prove the reliability of indication in accordance with IS 9921. These switches shall have three positions, viz. Open, Closed and Earthed and shall be constructed in such a way that natural interlocking prevents unauthorized operations. The

switches shall be fully assembled in the factory. Manual opening and closing shall be driven by a fast-acting mechanism, independent of operator's action.

- 6.2 Facility for remote operation in future shall be provided with an electrical operating mechanism in a remote location, without any modification of the operating mechanism and without de-energizing the Compact RMU. The switch and earthing switch mechanism shall have a mechanical endurance of at least 5000 operations.

7. CIRCUIT BREAKERS:

- 7.1 The Circuit Breakers shall be maintenance free. The position of power contacts and earthing contacts shall be clearly visible on the front of the Compact RMU. The position indicator shall provide positive contact indication in accordance with IS 9920. In addition, the manufacturer shall prove the reliability of indication in accordance with IS 9921. These switches shall have three positions, viz. Open, Closed and Earthed and shall be constructed in such a way that natural interlocking prevents unauthorized operations. They shall be fully assembled, tested and inspected in the factory.
- 7.2 An operating mechanism can be used to manually close the Circuit Breaker and charge the mechanism in a single movement. It shall be fitted with a local system for manual tripping. There should be no automatic reclosing. The Circuit Breaker shall be capable of closing fully and latching against the rated making current. Mechanical indication of the "OPEN" and "CLOSED" position of the Circuit Breaker shall be provided. The breakers of the same type and rating shall be interchangeable.
- 7.3 When the Circuit Breaker closing mechanism is of the spring-operated type, it should not be possible for the Circuit Breaker to close until the spring is fully charged and the associated charging mechanism is fully ready for closing. Wherever external spring charging handle is required to charge the spring, it should be ensured that the same is not allowed to move during the release of its spring energy. Alternately, it should not be possible to release the spring energy till the charging handle is completely disengaged from the mechanism. A visual mechanical indicating device shall be provided to indicate the status of spring viz., "SRING CHARGED" or "SPRING FREE". It shall be possible to charge the spring when the Circuit Breaker is closed and if the spring is released the Circuit Breaker should not open; nor this operation result in any mechanical damage to the component of the Circuit Breaker or its operating mechanism. Alternatively, fast acting reflex mechanism for Circuit Breakers is also acceptable. However, the Circuit Breakers shall be suitable for up gradation to remote operation without any changes.

7.4 The Circuit Breaker shall be provided with a suitable protection system that will operate without any auxiliary power supply under fault conditions. The protection system shall comprise of three numbers of Current Transformers of 10P10-accuracy class and have a rated burden of 15 VA and an electronic relay. The Current Transformers shall have a separate metering core of accuracy class 1.0 and burden 3.5 VA for future use. The Current Transformers and Static Relays shall conform to IS 2705 and IS 8686 respectively. The over current protection shall have two separate settings, one low setting with IDMT and the other high setting of definite time type. The earth fault protection shall operate by residual current measurement using the sum of sensory secondary currents. The relay shall be self-powered to operate and trip the Circuit Breaker. The relay shall be provided with a testing port in front of the relay. The range of relay settings from a range of 8 Amperes to 200 Amperes corresponding to the rating of underground cable network shall be available in the protection system.

8. CABLE TERMINATION:

- 8.1 The bushing should be conveniently located for workings with cables specified and allow for the termination of these cables in accordance with the prevailing practice and guidelines of cable manufacturers. The dimensions of the terminals shall be in accordance with IS 10601. A non-Ferro-magnetic cable clamp arrangement shall be provided for each cable to be terminated in the Compact RMU. Suitable locking arrangement of the Circuit Breakers, Earthing Switches and Load Break Switches with padlocks in the "Open" or "Closed" position shall be provided.
- 9.2 A "Cable Alive" indicator lamp in the front of Compact RMU shall be provided for each cable using a capacitance voltage divider.
- 9.3 It must be possible to test the core or sheath insulation of the cables without de-energizing the remaining section of the Compact RMU without accessing the cable compartment and without disconnecting the cable.

10 SAFETY OF EQUIPMENT:

- 10.1 In case of SF₆ filled equipment, any accidental overpressure inside the sealed chamber shall be limited by the opening of a pressure-limiting device in the rear part of the enclosure so that the gas will be released away from the operator.
- 10.2 All manual operations shall be carried out on the front of the Compact RMU. The effort required to be exerted on the lever by the operator shall not exceed 250 N.

11 FRONT PLATE:

11.1 The front plate shall be provided with IP2X degree of protection conforming to IS 12063. The front plate should include a clear mimic diagram indicating the functions. The position indicators shall correctly depict the position of the main contacts and shall be clearly visible to the operator. The lever operating direction shall be clearly indicated.

12 TESTS:

12.1 Type test reports for all the type tests required to be conducted as per the standards mentioned in these specifications shall be furnished prior to supply.

12.2 Routine tests and acceptance tests shall be conducted in accordance with these standards in presence of the purchaser's representatives. The contractor shall give at least 15 days advance notice for witnessing these tests. Copies of test reports of all these tests shall be furnished to the purchaser for approval. Each completely wired Compact RMU shall be tested to ensure all of its protective; control and interlock systems operate satisfactorily. The tenderer shall indicate the tests to be carried out in the field after the installation and before commissioning.

13 INSTRUCTION MANUALS:

13.1 Three copies of installation, operation and maintenance manuals shall be supplied along with the equipment. Two additional copies of these manuals shall be supplied at the time of commencement of works before the materials are supplied. These manuals shall be complete in all respects furnishing the constructional and operational features of the equipment. The same shall contain all the details and required drawings and/or illustrations along with the overall procedures to enable to identify all the parts and consumable spares, which may have to be identified readily for ordering purpose.

14 FORMATION OF COMPACT RMU:

14.1 The compact RMU shall be of single bus bar, outdoor type, tropicalized in accordance with the relevant clauses mentioned in these specifications. An earth fault passage indicator using a core balance Current Transformer shall be provided for the Incomers to assist in identifying the faulty cable section in order to isolate the same.

14.2 The Incomer panel shall comprise of, but not limited to the following:

1. A triple pole Vacuum / SF₆ Load Break Switch rated 630 Amps or higher, with a rated making capacity under fault conditions with short circuit levels of 25 KA or above at 11 KV

2. Core balance Current Transformer and earth fault passage indicators (The indicator flag of the relay shall be visible till such time the relay is reset manually) These shall not require any external Power Supply and must be suitable for unattended places.
- 14.3 The transformer loop circuit control panels shall consist of but not limited to the following:
1. A triple pole Vacuum/SF₆ Circuit Breaker rated 200 Amps or higher, with a rated making capacity under fault conditions with short circuit levels of 25 KA or above at 11 KV
 2. Manually charged spring closing mechanism
 3. Electronic relay with associated 15 VA burden Current Transformers of accuracy class 10P10 and tripping mechanism
 4. Mechanical "ON", "OFF" indicator
 5. Manual tripping device
 6. Mechanical "Spring Charged", "Spring Free" indicator in case of stored energy devices.
 7. Provision for retrofitting meters and SCADA System.

15 ACCESSORIES:

15.1 The following accessories shall be provided for each compact RMU:

1. Pad locks for all doors with one set (3 Nos.) Master keys
2. Earth bus formed out of 50X6 mm GI earthing flats
3. Wire guard protective mesh on the front doors and back for prevention of pasting of papers etc.
4. Base channel with foundation bolts
5. Ventilating louvers with weld mesh
6. Live part shrouds, danger plates, caution boards, name plates, rating plates etc. as per requirements
7. Bus bar supports (Porcelain insulator supports) as required
8. All other components, even though not specifically mentioned, but required for the safe operation of the unit.

16 INFORMATION TO BE FURNISHED PRIOR TO SUPPLY:

The following information shall be furnished:

1. Completely filled in the "Guaranteed Technical Particulars" given below
2. Catalogues describing the equipment duly indicating the model
3. Literature describing the operational features
4. Typical GA drawings
5. Type Test Certificates
6. Foundation drawings.

19 GUARANTEED TECHNICAL PARTICULARS FOR 11 KV CIRCUIT BREAKERS AND LOAD BREAK SWITCHES

A) SF6 / Vacuum Circuit Breaker:

a)	Type	
b)	Rated Voltage	
c)	Breaking Current	
d)	Making Current	
e)	Rupturing Capacity	
f)	Rated Current	
g)	No. of Poles	
h)	Operating mechanism	

B) Load Break Switches:

a)	Type	
b)	Duty cycle	
c)	Rated current	
d)	Rated breaking capacity	
e)	Fault making capacity	
f)	Rupturing Capacity	
g)	No. of poles	
h)	Operating mechanism	
i)	SF6 tank	
j)	Interlocks	
k)	Operation safety	

C) BUS BAR:

a)	Material	
b)	Type	
c)	Rated Current	
d)	Short time rating for 3 / 1 Sec.	

D) Protection:

a)	<u>Protection:</u>	
-----------	---------------------------	--

GUARANTEED TECHNICAL PARTICULARS FOR RMU

The Tenderer shall furnish the following data for the Load Break Switches and Circuit Breakers used in the Compact RMU:

1. Rated Voltage
2. Rated Insulation Level
3. Rated Frequency
4. Rated Normal Current
5. Rated cable charging breaking current
6. Rated short circuit breaking current
7. Rated transient recovery voltage for terminal faults
8. Rated characteristics for short line faults
9. Rated short circuit making current
10. Rated duration of short circuit
11. Rated opening time, break time and closing time
12. Type test certificates
13. Constructional features
14. Details of operating mechanism
15. Overall dimensions of Compact RMU
16. Limits of gas pressure (in case of SF₆ filled equipment)
17. Clearances between live parts and contacts
18. Total transportation weight
19. Special features if any
20. Foundation loads and details
21. Internal Arc Test for Outdoor applications.

SECTION – 5
**U.G. CABLE OF ROUND ARMoured AND
PRESSURE EXTRUDED 11KV CLASS XLPE**

**TECHNICAL SPECIFICATIONS FOR CROSS LINKED POLYETHYLENE INSULATED 3 CORE
11KV CABLES****1.00.00 SCOPE:**

- 1.01.00 The scope of this package, covers the design, manufacture, stage inspection at works, inspection and testing of finished cables at manufacture's works, testing at independent test house, packing, transport and delivery to consignee's address of 6.35/11KV Three Core, aluminum conductor, XLPE insulated, screened, underground Cables as per specified construction.
- 1.02.00 Technical Requirement: Three Core 6.35/11KV grade, 90°C rating heavy duty power cable with stranded compacted circular aluminum conductor shielded with extruded semi conducting compound, cross linked polyethylene insulated, shielded with extruded semi conducting compound and copper tape, shielded cores laid up with fillers, inner sheath of extruded PVC, Galvanized round steel wire Armor and PVC ST-2 overall sheath.
- 1.03.00 The cables should be suitable for use in solidly earthed system.
- 1.04.00 The Stranded Aluminum Conductor for different sizes of cable shall have the short circuit rating specified in this document, in schedule of requirement, schedule-I, Annexure TS-1.

2.00.00 STANDARDS:

- 2.01.00 The 11KV UG Cables shall, in general, meet the requirements of the latest edition of the Bureau of Indian Standards, (generally referred as IS) IS 7098 (Part-2) 1985. The cables manufactured to and meeting the testing requirements of international standards, like B.S.S. IEC or equivalent standards are also acceptable. The bidders shall enclose a copy of the equivalent international standard, in English Language, along with the Bid.

The extracts from IS 7098 (Part 2) are given in Annexure TS-3.

The cables and components in general shall meet the requirement Indian Standards with latest amendments or equivalent International Standards.

IS: 7098 (Part 2)	1985	:	Specification for cross linked polyethylene insulated PVC sheathed cables
IS: 8130	1984	:	Specification for conductors for insulated Electric Cables
IS: 3975	1979	:	Specification for mild steel wires, strips and tapes for armouring of cables.
IS: 10810 (Part 1 to 55)	1984	:	Specification for test on cables
IS: 5831	1984	:	Specification for PVC insulation and sheath of electric cables
IS: 10418	1982	:	Specification for drums for electric cables
IS: 10462 (Part-I)	1983	:	Fictitious calculation method for determination of dimensions of protective covering of cables: Part-I Elastomeric and thermoplastic insulated cables.

- 2.02.00 11KV underground cables shall be manufactured to the highest quality, best workmanship with scientific material management and quality control. The Bidder shall furnish the quality plan, giving in details the quality control procedures/management system.

The successful bidder shall give sufficient advance notice to the purchaser of not less than fifteen days to arrange for stage inspection and inspection of quality assurance programme during manufacture, at the works.

3.00.00 **SYSTEMS DETAILS:**

General Technical Particulars:

1) Nominal System Voltage (rms) (u)	-	11 KV
2) Highest System Voltage (rms) (um)	-	12 KV
3) Phase to Earth Voltage (uo)	-	6.35 KV
4) Number of Phases (for 3 core cables)	-	3
5) Frequency	-	50 Hz
6) Variation in frequency	-	±3%
7) Type of Earthing	-	Solidly Earthed
8) Basic impulse level (1.2/50 Micro Second Wave)	-	75 KV
9) Total relay & circuit break operating time	-	15-20 Cycles
10) One minute power frequency withstand voltage	-	28 KV

4.00.00 **INSTALLATION CONDITIONS:**

- Mostly directly buried in ground, partly in RCC/Hume pipes or stoneware pipes at road crossing in case of 3 core cables.
- If more than one circuit is laid in the same trench, then laid in flat formation for 3 core cables.
- Metallic coverings are connected solidly to earth at both ends of the run for 3 core cables and.
- Normal depth of laying is 900 mm to 1000 mm (from top of round to entre of cable).
- Nature of soil – Heterogeneous, sandy.
- Soil resistivity: variable 18 to 100 Ohm – meter
- Soil Thermal resistivity (assumed) 120 to 150 dig. C. Cm/w.

5.00.00 **CLIMATIC CONDITIONS:**

The climatic conditions at Bangalore City where these 11KV Cables will be installed are as under:

1	Location	Karnataka (28.58 N, 77.38E)
2	Altitude	1000 M above MSL
3	Max. ambient air temperature	45 ⁰ C
4	Max. daily average air temp.	38 ⁰ C
5	Minimum ambient air temp.	10 ⁰ C
6	Ground temperature at depth of laying assumed	35 ⁰ C (Max.)
7	Isoceranic level	5 ⁰ C (Min.)
8	Avg. annual rainfall	As per IS:45
9	Avg. number of rainy	1450 Sq.mm.

10	Climate	Tropical Moderately hot and humid
11	Soil	Normally dry. As per IS:1200 Part-I, 1974, likely hood of subsoil water at certain location at depth of burial of cables.

6.00.00 **DESIGN CRITERIA:**

- 6.01.00 The cables that are covered in these specifications are intended for use in the Karnataka Power distribution system, under the climatic conditions and installation conditions described in the technical specification.
- 6.02.00 Any technical feature, not specifically mentioned here, but is necessary, for the good performance of the product, shall be incorporated in the design. Such features shall be clearly brought out under technical deviations schedule only in the offer made by the Bidder, giving technical reasons, and justifying the need to incorporate these features.
- 6.03.00 For continuous operation of the cables, at specified drawing, the maximum conductor temperature shall be limited to the permissible value as per the relevant standard, generally not exceeding 90⁰C under normal operation and 250⁰C under short-circuit conditions.
- 6.04.00 The cables in service will be subject to daily load cycles, of two peaks during day, morning peak and evening peak with reduced loading during the nights.
- 6.05.00 The materials used for sheaths shall be resistant to oils, acids and alkalies.
- 6.06.00 The cables shall be designed to withstand the thermo mechanical forces and electrical stresses during normal operation and transient conditions.

The Cables shall be designed to have a minimum useful life span of forty years.

Core identification: The core identification for 3 core cables shall be provided, by suitable means, like, by application of colored stripes, or by numerals or by printing on the cores as per clause 13 of IS:7093.

7.00.00 **MANUFACTURE PROCESS, CROSS LINKING OF INSULATION:**

- 7.01.00 Cross linking of the insulation materials (pre compounded polyethylene) shall be conforming to IS:7098 (Part-II).
- 7.02.00 The conductor screen shall be of extruded semi conducting compound. The insulation screen shall consist of the nonmetallic part extruded semi conducting compound with non magnetic metallic part. The XLPE insulation and the shields for conductor and insulation shall be extended in one operation.

8.00.00 **MATERIALS:**

- 8.01.00 **CONDUCTOR:** The conductor shall be of stranded construction. The material for conductor shall consist of plain aluminum of H2 or H4 grade as per clause-3 of IS:8130/1984.

The number of wires in the conductor shall be not less than the appropriate minimum number given in Table-2 of IS:8130/1984.

- 8.02.00 **INSULATION:** The insulation shall be cross linked polyethylene conforming to the requirements given in Table-1 of IS:7098 Part-II.

8.03.00 **SCREENING:** The screening shall consist of semi conducting compound. The metallic screen for core shall consist of copper tape. The metallic screen with Armour shall be designed to carry the minimum short circuit rating for 1 second. (The design calculations shall be furnished by the tenderer).

8.03.01 The semi-conducting compound shall withstand the operating temperature of the cable and shall be compatible with the insulting materials.

8.04.00 **Filler and inner sheath for Multi Core Cables:**

For Multi Core cables, the interstices at the centre shall be filled with a non-hygroscopic material.

The interstices around the laid-up cores shall be covered with PVC compound type S.T-2. This will form the inner sheath for Multi Cores Cables.

8.05.00 **ARMOURING FOR 3 CORE CABLES:**

The armour shall be galvanized round steel wire, complying with the requirements of IS:3975. The Single Core Cables shall be armoured with hard drawing Aluminium round wire. A binder tape may be applied on the armour.

8.06.00 **OUTER SHEATH:**

The outer sheath shall consist of Poly Vinyl Chloride (PVC) compound, confirming to the requirements of Type ST-2 of IS:5831 suitable additive shall be added to give anti termite protection.

9.00.00 **CONSTRUCTION:**

The general constructional features of the cables shall be as follows:

- a) **3 Core Cables:** Stranded, Compacted, Circular, Aluminium Conductor, Conductor Screen of extruded semi conducting compound, Cross linked polyethylene insulation, shall be conforming to IS:7098 (Part-II).

Insulation screen consisting of non-metallic part of extruded semi conducting compound and the metallic part of copper tape(s).

Pressure Extruded PVC inner sheath
Armour (Galvanised Steel round wire)
Other PVC sheath with anti-termite treatment.

10.00.00 **CONDUCTOR:**

10.01.01 The conductor shall be stranded, compact, circular of aluminium wires of H2 or H4 grade plain aluminium wires.

10.01.02 The conductor shall be clean, uniform in size and shape smooth and free from harmful defects.

- 10.01.03 Not more than two joints shall be allowed in any one of the single wire forming every complete length of conductor and no joint shall be within 300 mm of any other joint in the same layer. The joint shall be made by brazing, silver soldering or electric or gas welding.
- 10.01.04 No joints shall be made in the conductor after it has been stranded.
- 10.02.00 **CONDUCTOR SCREEN**: The conductor screen shall be provided over the conductor consisting of extruded non metallic semi conducting compound.
- 10.03.00 **INSULATION**: The insulation shall be provided over the screened conductor with cross linked polyethylene, applied by extrusion and shall be of high quality, cross linked, shall be conforming to IS:7098 (part-2).
- 10.03.01 **THICKNESS OF INSULATION**: The average thickness of XLPE insulation shall not be less than the nominal value subject to the applicable tolerance as specified in table 2 of IS: 7098.
- 10.03.02 The insulation shall be applied to closely fit on the conductor screen, and it shall be possible to remove it without damaging the conductor.
- 10.03.03 The thickness of semi conducting screen over insulation should not be included in the thickness of Insulation.
- 10.04.00 **INSULATION SCREENING**: The Insulation screen shall be applied over the Insulations.
- 10.04.01 The Non-Metallic part of the Insulation screen shall consist of extruded Semi conducting compound.
- 10.04.02 The metallic part of the insulation screen shall consist of non-magnetic material, consisting of copper tape or tapes, and shall be applied over the non-metallic part. The metallic tape(s) shall be designed to carry the rated short circuit current.
- 10.05.00 **LAYING UP OF CORES**: For multi-core cables, the cores shall be laid together with a suitable right hand lay. The interstices at the center shall be filled with a non-hygroscopic material.
- 10.06.00 **INNER-SHEATH FOR MULTI CORE CABLES**:
- 10.06.01 The cores shall be laid up with a suitable right hand lay and the interstices should be filled with PVC compound type ST2 conforming to IS:5831 or equivalent standard. The filling up of interstices shall be by pressure extrusion and this circular shape and shall bind the cores also.
- 10.06.02 The minimum thickness of the inner sheath shall conform to Table 3 of IS: 7098 (Part-2), 1985 or equivalent standard.
- 10.06.03 The inner-sheath shall be so applied that it fits closely on the laid-up cores and it shall be possible to remove it without damage to the insulation cables.
- 10.07.00 **ARMOURING FOR 3 CORE CABLES**:
- 10.07.01 **Application**: The armour consisting of Galvanized steel wire shall be applied over the inner sheath for multi core cables.
- 10.07.02 The armor wires shall be applied as closely as possible.
- 10.07.03 The diameter of the galvanized round steel and hard drawn aluminum wires shall conform to IS: 7098 Part (2).

- 10.07.04 A binder tape may be applied on the armour.
- 10.07.05 The Joints in the armour wires shall be brazed/welded with joint surface and rendered smooth. The joints shall be staggered by at least 300 mm from the nearest joint in any other armour wire in the completed cable.
- 10.08.00 **OUTER SHEATH:**
- 10.08.01 The PVC outer sheath with anti termite treatment shall be extruded over the armouring for 3 core cables.
- 10.08.02 The color of the outer sheath shall be black.
- 10.08.03 The thickness of outer sheath shall be not less than the minimum value specified in column 5 of Table 5 of IS: 7098 (Part-2) 1985.
- 10.09.00 **IDENTIFICATION:** The outer-sheath shall have the following information embossed or indented on it, the manufacturer's name or trade mark, the voltage grade, the year of manufacture and the letters "BESCOM". The identification shall repeat every 300/350 mm along with length of the cable.
- 11.00.00 **INSPECTION:**
- 11.01.00 **Quality Control:** The Bidder shall furnish a complete and detailed quality plan for the manufacturing process of the cable. All raw materials shall conform to relevant applicable standards and tested for compliance to quality and requirement.
- During the manufacturing process, at all stages, inspections shall be made to check the physical and dimensional parameters, for verification to compliance to the standards.
- 11.02.00 The Bidder shall arrange, for inspection by the purchaser, during manufacture, if so desired by the purchaser, to verify the quality control process of the Bidder.
- 12.00.00 **TYPE TESTS:**
- Notwithstanding, that type test has been conducted earlier, the successful bidder the each member of consortium shall conduct all type tests as per IS:7098 part (2), 1985 with upto date amendments or equivalent international standard at his cost at either CPRI or any other accredited national laboratory/testing house and materials offered for inspection. Only after approval of the test reports from the purchaser materials shall be offered for inspection.
- 12.01.00 All type tests, routine, acceptance test shall be conducted in the presence of the purchaser, representative.
- 12.02.00 The successful Bidder shall give 15 days advance notice for inspections, and witnessing of tests by the purchaser or his representative.
- 12.03.01 The following type tests will be conducted on the cable.
- a) Test on conductor
 - b) Test on armour wires
 - c) Test for thickness of XLPE insulation and inner and outer sheaths
 - d) Physical test on XLPE insulation
 - e) Physical test for outer sheath

- f) Partial discharge test
- g) Bending test
- h) Di-electric power factor test
 - (i) As a function of voltage
 - (ii) As a function of temperature
- i) Insulation resistance (Volume resistivity) test
- j) Heating cycle test
- k) Impulse withstand test
- l) High voltage test
- m) Flammability test

12.03.02 The following test shall be performed successively on the same test sample of completed cable, not less than 10 M in length between the test accessories.

- a) Partial discharge test
- b) Bending test followed by partial discharge test
- c) Dielectric power factor as a function of voltage
- d) Dielectric power factor as a function of temperature
- e) Heating Cycle test, followed by dielectric power factor and function of voltage and partial discharge test.
- f) Impulse withstand test
- g) High voltage test.

12.04.00 **ACCEPTANCE TEST:**

12.04.01 The sampling plan for acceptance test shall be as per IS:7098 Part (2) 1985, Appendix 'A'.

12.04.02 The following shall constitute the acceptance test.

- a) Tensile test for aluminium
- b) Wrapping test for aluminium
- c) Conductor resistance test
- d) Test for thickness of insulation
- e) Test for thickness of inner and outer sheath
- f) Hot-set test for insulation
- g) Tensile strength and elongation at break test for insulation and outer sheath
- h) Partial discharge test (on full drum length)
- i) High voltage test
- j) Insulation resistance (volume resistivity) test.

12.05.00 **ROUTINE TEST:**

The following shall constitute routine tests:

- a) Conductor resistance test
- b) Partial discharge test on full drum length
- c) High voltage test

13.00.00 **PACKING:**

13.01.01 The cables, as per specified delivery lengths, shall be securely wound/packed in non-returnable, well seasoned sturdy wooden drums, with strong reinforcements so as to withstand rough handling during transport by Rail, Road etc., The packing should withstand storage conditions in open yards. The cable drums shall conform to IS:10418-1982 or equivalent standard.

13.01.02 The drawing of cable drums with full detail shall be furnished, and got approved before dispatch.

13.02.00 **SEALING OF CABLE ENDS ON DRUMS:**

13.02.01 The Cable ends shall be sealed properly so that ingress of moisture is completely prevented.

13.02.02 The individual core endings shall be sealed effectively with water resistant compound applied over the core and provided with a heat shrinkable cap of sufficient length with adequate cushion space so that the conductor does not puncture the cap in case of movement of the core during unwinding or laying. Before sealing, the semi conducting layer on the cores may be removed for about 2 mm at each end, to facilitate checking the insulation resistance from one end, without removing the sealing cap at the other end.

13.02.03 The three cores should have a over all heat shrinkable cap with adequate end clearance, and sufficient cushioning to prevent puncturing of the overall sealing cap due to stretching of the cores. The sealing cap shall have sufficient mechanical strength and shall prevent ingress of moisture into the cable.

13.02.04 **CABLE LENGTHS:** The cables shall be supplied in continuous lengths of 250/500 m in case of 3 core cables with a tolerance of $\pm 5\%$ of drum length.

13.02.05 **QUANTITY TOLERANCE:** $\pm 5\%$ tolerance shall be allowed on the ordered quantity.

14.00.00 **MARKING:**

The packed a cable drum shall carry the following information, clearly painted or stenciled.

- a) The letters "BESCOM"
- b) Reference to Standard and ISI Mark
- c) Manufacture's Name or trade mark
- d) Type of Cable & Voltage grade
- e) Number of cores
- f) Nominal cores sectional area of conductor
- g) Cable code
- h) Length of cable on the drum
- i) Direction of rotation
- j) Gross weight
- k) Country of Manufacture
- l) Year of Manufacture
- m) Purchase Order No. and Date
- n) Address of consignee.

15.00.00 Cross sectional drawings of the cables giving dimensional details for each size of cable.

- a) An illustrated literature on the cable giving technical information, on current ratings, cable constants, short circuit ratings, derating factors for different types of installation packing date weights and other relevant information.

SCHEDULE-I**Annexure: TS-1**

Schedule of requirement of 3 core armoured, 1 core armoured, 6.35/11KV (E) aluminium conductor, XLPE UG Cables

Sl. No.	Cross sectional area of conductor (Sq.mm.)	Minimum current rating (Amps) in ground	Minimum short circuit rating (KA/1 Sec)	Delivery length per drum ($\pm 5\%$)
1	3 x 95	190	8.9	500 M
2	3 x 240	315	22.5	250 M
3	3 x 400	395	37.6	250 M

The approximate current ratings in column 3 are for the following standard installation conditions.

i)	Maximum conductor temperature for continuous operation	90 Deg. C.
ii)	Ambient air temperature	40 Deg. C.
iii)	Ground temperature	30 Deg. C.
iv)	Thermal resistivity of soil	150 Deg. C.
v)	Depth of laying	90 cm
vi)	Maximum conductor temperature at the end of short circuit	250 Deg. C.
vii)	Method of installation	Installed single directly buried in ground

SCHEDULE-II**Annexure: TS-2**

For the information of Bidder the important extracts from the Indian Standard IS:7098 (Part 2) 1985; "Specification for cross linked polyethylene insulated PVC sheathed cables are furnished here for their reference and to supply for the XLPE Cables called for in the bid specification

TABLE-1:- PROPERTIES OF XLPE INSULATION

Sl. No.	Property	Requirement
1	Tensile Strength	12.5 N/Sq.mm. Min.
2	Elongation at break	200 percent, Min.
3	<u>Ageing in air over:</u> a) Treatment: Temperature	135 \pm 3 Deg. C

	Duration b) Tensile Strength Variation c) Elongation Variation	7 Days ± 25% Max. ± 25% Max.
4	Hot Set: a) <u>Treatment:</u> Temperature Time under load Mechanical stress b) Elongation under load c) Permanent Elongation (Set after cooling)	200 ± 3 Deg. C 15 minutes 20 N/Sq.mm. 175% Max. 15% Max.
5	Shrinkage: a) <u>Treatment:</u> Temperature Duration b) Shrinkage	130 ± 3 Deg. C 1 Hour 4% Max.
6	Water absorption (gravimetric): a) <u>Treatment:</u> Temperature Duration b) Water absorbed	85 ± 2 Deg. C 14 Days 1 Mg/Sq.mm. cm. Max.
7	Volume resistivity: a) At 27 Deg. C b) At 90 Deg. C	1 x 10 ¹⁴ ohm-cm. Min. 1 x 10 ¹² ohm-cm. Min.

TABLE-2:- NOMINAL THICKNESS OF INSULATION

Nominal Area of Conductor in Sq.mm.	Nominal thickness of insulation (ti) in mm. 6.35/11KV – 3 Core
95	3.6
240	3.6
400	3.6

- 1) Thickness of insulation: The average thickness of insulation shall not be less than the nominal value (ti) specified in Table-2.
- 2) Tolerance on thickness of insulation: The smallest of the measured values of thickness of insulation shall not fall below the nominal value (ti) specified in Table-2 by more than 0.1 mm + 0.1 ti.

TABLE-3:- THICKNESS OF INNER SHEATH (All dimensions in mm)

Calculated diameter over laid up cores (ref. IS 10462 Part 1, 1983) *		Thickness of inner sheath (Min.)
Over	Upto & including	
(1)	(2)	(3)
-	25	0.3

25	35	0.4
35	45	0.5
45	55	0.6
55	-	0.7

(*) Fictitious calculation method for determination, dimensions of protective coverings of cables: Part-I Electrometric and Thermoplastic Cables.

TABLE-4:- DIMENSIONS OF ARMOUR GALVANIZED STEEL ROUND WIRES AND STRIPS

NOTE: The dimensions of Galvanised steel wires or strips shall be as specified in Table-4.

Calculated diameter for Armour (ref. IS 10462 Part 1, 1983) *		Nominal thickness of steel strip	Nominal diameter of Round wire
Over	Upto & including		
1	2	3	4
a) For all diameter in excess of 13		0.8	Nil
-	13	-	1.40
13	25	0.8	1.60
25	40	0.8	2.00
40	55	1.4	2.50
55	70	1.4	3.15
70	-	1.4	4.00

Note: (a) and (b) indicate two methods of practice in the application of armouring.

* Fictitious calculation method for determination of dimensions of protective covering of cables: Part-I Electrometric & Thermoplastic Insulated Cables.

TABLE-5:- THICKNESS OF OUTER SHEATH (All dimensions in mm)

Calculated diameter under the outer sheath (ref. IS:10462 Part 1, 1983) *		Nominal thickness of steel strip		Minimum thickness of outer sheath for Armoured Cables
Over	Upto & including	Nominal (ts)	Minimum	
1	2	3	4	5
-	15	1.8	1.24	1.24
15	25	2.0	1.40	1.40
25	35	2.2	1.56	1.56
35	40	2.4	1.72	1.72
40	45	2.6	1.88	1.88
45	50	2.8	2.04	2.04
50	55	3.0	2.20	2.20
55	60	3.2	2.36	2.36
60	65	3.4	2.52	2.52
65	70	3.6	2.68	2.68
70	75	3.8	2.84	2.84
75	-	4.0	3.00	3.00

(*) Fictitious calculation method for determination of dimensions of protective covering of cables: Part-I Electrometric & Thermoplastic Insulated Cables.

Note:

Armoured Cables: The thickness of outer sheath shall be not less than the minimum value specified in column 5 of Table-5.

Extracts from IS:7098 (Part 2), 1985, on Tests on Cables:

- i) Partial Discharge Test: The Partial discharge magnitude at test voltage equal to 1.5 U_o shall not exceed 20 PC.
- ii) Bending Test: The diameter of test cylinder shall be (20D ±5) percent, where D is the overall diameter of the completed cable.
- iii) Dielectric Power Factor Test:
 - a) Tan 'delta' as a function of voltage:
The measured value of tan 'delta' at U_o shall not exceed 0.004 and the increment of tan 'delta' between 0.5 U_o and 2 U_o shall not be more than 0.002.
 - b) Tan 'delta' as a function of temperature:

The measured value of tan 'delta' shall not exceed 0.004 at ambient temperature and 0.008 at 90 Deg. C.
- iv) Heating Cycle (As per IS: 10810 Part 49):

After their cycle, the sample shall be subjected to dielectric power factor as a function of voltage and partial discharge test.
- v) Impulse withstand test:

The impulse voltage level for cables of rated voltage 6.35/11KV is 75 KV. No breakdown of insulation shall occur during the test.
- vi) High voltage test (As a type test/Acceptance test) for 6.35/11KV rated voltage cables:

The cable shall withstand without breakdown an A.C. Voltage equal to 3 U_o but not less than 17 KV (rms when applied to the sample between conductor and screen/metallic tape/armour, the voltage shall be gradually increased to the specified value and maintained for a period of 4 hours.

General Technical Parameters

Sl. No.	Particulars	unit	HT UG Cable
1	Cables		
	a) Name of manufacturer		
	b) Place of manufacture		
2	Cable Type		A2XWY
3	Applicable specificaton & standards voltage Grade		IS: 7098 (Part-2) /11kV
4	Suitable for effective Earth/Unearth system		
6	Permissible voltage & frequency variation for satisfactory operation		

7	Continuous current for standard conditon as per IS:		
	a) In air (45° C)	Amps	
	b) In Ground (30° C)	Amps	
	c) In Duct	Amps	
8	Conductor		
	a) Material		Aluminium (H2/H4 Grade)
	b) Shape of conductor		Strandard compacted circular
	c) Geometrical cross sectional area	mm ²	
	d) Number of wire: (min)	No	
	e) Diameter of Wire : mm before compacting & strand Diameter	mm	
	f) Maximum DC resistance of the conductor at 20° C	Ω/KM(CR value only for reference)
	g) Sampling batch for test		10% of ordered quantity
9	Conductor Screening		
	a) Material		Pressure Extruded Semiconducting compound
	b) Process		Triple Extrusion
	c) Thickness (Min)	mm	
	d) Continuous working temp	deg.C	90
	e) Max allowable temp at termination of short circuit	deg.C	250
10	Insulation:		
	a) Material		XLPE
	b) Thickness of Insulation (Nom)	mm	
	i) Between Cores	mm	
	ii) Between Cores & Inner Sheath		
	c) Minimum thickness of insulation at any one point	(mm)	
	d) Extrusion Type		Pressure Extruded
	e) Specific insulation resistance at 90° C	Ohm-cm	
	f) Hot Set test:		
	a) Elongation under load	% Max
	b) Maximum Permanent elongation after cooling	%Max
	c) Tensile Strength at break	N/mm ² Minimum
	d) Elongation at break	% Min
11	Insulation Screening:		
	a) Material		Extruded Cross linked semi conducting compوند
	b) Min. Thickness of extruded semi conducting layer	mm	

	c) Metallic Part: (Material)		Plain copper tape
	d) Size of copper Tape	mm	0.045
	e) Whether over lapping provided		Min 5% of Overlapping
	f) Short Circuit rating in 1 sec.	KA	
12	Inner Sheath		
	a) Material		PVC -ST2
	b) Extrusion Type		Pressure Extruded
	c) Thickness (Min)	mm	
	d) Nominal Dia over Inner Sheath	mm	
13	Armouring		
	a) Material		Galvanised Steel
	b) Type of armouring		Round wire
	c) Nominal Dimension of Armour wire	mm Dimension and % of Tolerance
	d) Minimum Number of Armour wire	 Numbers (Minimum)
	e) Whether Galvanised		
	f) Mass of Zinc coating	gm/mm ²	
	g) Nominal Dia over Armouring	mm	
	h) Short Circuit rating in 1 sec	KA	
14	Outer Sheath		
	a) Material		Extruded PVC Compound Type ST-2
	b) Extrusion type		Extruded
	c) Min. thickness of sheath	mm	
	d) Nominal Overall diameter of cable	mm	
	e) Thermal stability test for sheath	Minutes	100 minutes (Min) Number of test specimen:6 Test results shall be within the range of $\pm 5\%$ variation.
15	Short circuit withstand capacity		
	a) Short Circuit withstand capacity	KA	
	b) Duration of short circuit	sec	one
16	AC resistance per core at operating temperature	ohm/km	
17	Reactance Ohm/Km	ohm/km	
18	Capacitance per core	μ F/Km	
19	Allowable maximum conductor temperature when carrying current		
20	Insulation resistance at 27° C	ohm-cm	
21	Loss tangent		
22	Maximum cable charging current at normal operating volt	A/km	
	Additional data		

23	Core identification		Application of coloured stripes Red, Yellow & Blue
24	Standard Packing Length and Tolerance	Mtrs	
25	Scheme of identification of the cable		manufacturer's name or trade mark, voltage grade, year of manufacture and the letters "BESCOM". The identification shall repeat every 300/350 mm along with length of the cable.

SECTION – 6

1.1 KV CROSS-LINKED POLYETHYLENE INSULATED ARMoured PVC SHEATHED U.G. CABLE

TECHNICAL SPECIFICATION FOR 1.1 KV CROSS-LINKED POLYETHYLENE INSULATED (HEAVY DUTY) ARMOURED PVC SHEATHED UG CABLE.

1. SCOPE:

The scope of this specification covers the design, manufacture, stage inspection at work, inspection and testing of finish cables at manufacturers works, testing at independent test house, packing, transport and delivery to consignee address of 1.1 KV stranded aluminum, XLPE insulated heavy duty armoured and sheathed power cable for working voltages up to and including 1100 volts underground cables as per specified construction.

2. TECHNICAL REQUIREMENT:

1.1 KV grade, 90° C rating heavy duty power cable with stranded circular shaped aluminum conductor cross linked polyethylene insulated inner sheathed of extruded PVC, galvanized steel strip armoured and PVC ST-2 overall sheathed.

The cable should be suitable for use in solidly earthed system.

3. STANDARDS:

3.01 The 1.1 KV UG cable shall, in general meet the requirements of the latest edition of the Bureau of Indian Standards (Generally refereed as IS), IS: 7098 (Part-I) 1988.

3.02 The cables and components in general shall meet the requirements of the following standards with latest amendments or equivalent international standards.

IS:7098 (Part-I)	1988	:	Specification for cross linked polyethylene insulated PVC sheathed cables.
IS:8130	1984	:	Specifications for conductors for insulated Electric Cables.
IS:3975	1988	:	Specification for mild steel wires, strips and tapes for armouring of cables.
IS:10810 (Part 1 to 55)	1984	:	Specification for test on cables.
IS:5831	1984	:	Specification for PVC insulation and sheath of electric cables.
IS:10418	1982	:	Specification for drums for electric cables.
IS:10462	1983	:	Fictitious calculation method for determination of dimensions of protective coverings of cables: part 1 elastomeric and thermoplastic insulated cable.

3.03 The 1.1 KV underground cables shall be manufactured to the highest standard quality, best workmanship with scientific material management and quality control. The bidder shall furnish the quality plan, giving in detail the quality control procedures/management system.

3.04 The successful bidder shall give sufficient advance notice to the purchaser of not less than fifteen days to arrange for stage inspection and inspection of quality assurance program during manufacture, at the works.

3.05 Cable complying with other internationally accepted standards such as IEC, VDE, IPCEA etc., will also be considered in case they ensure performance and constructional features equivalent

or superior to standards listed above. In such a case, the Bidder shall clearly indicate the standard/standards adopted and furnish a copy of English version of the latest revision of standard(S) along with a tender and shall clearly bring the salient features for comparison.

- 3.06 In case of any conflict between the referred specification code or standards and this technical specification, the latter shall prevail to the extent of such difference.
- 3.07 1.1 KV Grade Power Cables to be supplied under this package shall be ISI approved and marked as such. Non compliance of above shall not be accepted.
- 3.08 However, if cable to be supplied under this specification are manufactured out side India and conform to other internationally accepted equivalent or superior standards the above clause shall not be applicable.

4. DESIGN CRITERIA:

- 4.01 The cables that are covered in these specifications are intended for use in the Karnataka Power distribution system, under the climatic conditions and installation conditions described in the technical specification.
- 4.02 Any technical feature, not specifically mentioned here, but is necessary for the good performance of the product, shall be incorporated in the design. Such features shall be clearly brought out under Technical deviations schedule only in the offer made by the bidder, giving technical reasons and justifying the need to incorporate these features.
- 4.03 For continuous operation of the cables, at specified rating the maximum conductor temperature shall be limited to the permissible value as per the relevant standard, generally not exceeding 90° C under normal operation and 250° C under short-circuit conditions.
- 4.04 The cables in service will be subject to daily load cycles of two peaks during day, morning peak and evening peak, with reduced loading during the nights.
- 4.05 The materials used for sheaths shall be resistant to oils, acids, alkalies and chemicals.
- 4.06 The cables shall have the mechanical strength required during handling and laying.
- 4.07 The cables shall be designed to withstand the thermo-mechanical forces and electrical stresses during normal operation and transient conditions.
- 4.08 The cables shall be designed to have a minimum useful life span of forty years.
- 4.09 Core identification: the core identification for cables shall be provided, by suitable means, like, by application of coloured stripes or any numerals or by printing on the cores as per Clause-10 of IS : 7098.
- 4.10 For identification coloured stripes, red, yellow & blue colours shall be used to identify the phase conductors & black to identify reduced neutral conductor.

5. MANUFACTURE PROCESS, CROSS LINKING OF INSULATION:

- 5.01 Cross linking of the insulation material (Pre compounded polyethylene) shall be conforming to IS:7098 (Part-I).
- 5.02 The conductor shall be of extruded semi conducting compound. The insulation screen shall consist of the non-magnetic metallic part. The XLPE insulation and the shields for conductor and insulation shall be extruded in one operation.

6. MATERIALS:

6.01 Conductor: the conductor shall be of stranded Construction. The material for conductor shall consist of plain aluminum of H2 or H4 grade as per Clause –3 of IS: 8130/1984.

The No. of wires in the conductor shall be not less than the appropriate minimum number given in Table-2 of IS: 8130/1984.

6.02 INSULATION: The insulation shall be cross linked polyethylene conforming to the requirements given in Table-1 of IS: 7098 Part-I.

6.03 For multicore cables, the interstices at the Centre shall be filled with a non-hygroscopic material. The interstices around the laid up cores shall be covered with PVC compound type S.T.2. This will form the inner sheath for multicores.

ARMOURING: The armour shall be galvanized steel strip, complying with the requirements of IS: 3975.

6.04 OUTER SHEATH:

The outer sheath shall consist of Poly Vinyl Chloride (PVC) compound, conforming to the requirements of Type ST-2 of IS: 5831 suitable additives shall be added to give anti termite protection.

7. CONSTRUCTION:

7.01 The general constructional features of the cables shall be as follows:

- a) Stranded circular shaped Aluminium conductor. Cross linked polyethylene insulation, cross linked shall be conforming to IS: 7098 (Part-I) 1988 with its latest amendment. Extruded PVC inner sheath. Armour (Galvanized steel strip). Outer PVC sheath with anti-termite treatment.
- b) Cables with reduced neutral conductor shall have sizes as given in table-2 of IS: 7098 Part-I.

8. CONDUCTOR:

8.01 The conductor shall be stranded circular shaped Aluminium wires of H2 or H4 grade plain aluminium wires.

8.02 The conductor shall be clean, uniform in size and shape smooth and free from harmful defects.

8.03 Not more than two joints shall be allowed in any one of the single

8.04 Forming every complete length of conductor and no joint shall be within 300mm of any other joint in the same layer. The joint shall be made by brazing silver soldering or electric or gas welding.

8.05 No joints shall be made in the conductor after it has been stranded.

- 8.06 INSULATION: The insulation shall be provided over the conductor with cross linked polyethylene, applied by extrusion and shall be of high quality, cross linked, shall be confirming of IS:7098 (Part-I).
- 8.07 THICKNESS OF INSULATION: The average thickness of XLPE insulation shall not be less than the nominal value subject to the applicable tolerance as specified in table 3 of IS: 7098.
- 8.08 The insulation shall be applied to closely fit on the conductor screen and it shall be possible to remove it without damaging the conductor.

9. LAYING UP OF CORES:

- 9.01 For multicore cables, the core shall be laid together with a suitable right hand lay, where necessary the interstices at the center shall be filled with a non-hygroscopic material.
- 9.02 Inner sheath for Multi core cables:
- 9.03 The cores shall be laid up with a suitable right hand lay and the interstices should be filled with PVC compound type ST-2 conforming to IS: 5831 or equivalent standard.
- 9.04 The minimum thickness of the inner sheath shall conform to Table 5 of IS: 7098 (Part-I), 1988 or equivalent standard.
- 9.05 The inner sheath shall be so applied that it fits closely on the laid up cores and it shall be possible to remove it without damage to the insulation.

10. ARMOURING:

Application

- 10.1 Armouring shall be applied over the insulation in case of single core cables and over the inner sheath in case of twin, three and multicore cables.
- 10.2 The armour stripes shall be applied as closely as practicable.
- 10.3 The direction of lay of the armour shall be left hand. For double strip armoured cables, this requirement shall apply to the inner layer of strips. The outer layer shall, except in special cases, be applied in the reverse direction to the inner layer and there shall be a separator of suitable non-hygroscopic material.
- 10.4 DIMENSIONS: The dimensions of galvanized steel stripes shall conform to table 6 of IS: 7098 (Part-I).
- 10.5 A binder tape may be applied on the armour.
- 10.6 JOINTS: The joints in armour strip shall be made by brazing or welding and the surface irregularities shall be removed. A joint in any strip shall be at least 300 mm from the nearest joint in any other armour strip in the completed cable.

11 OUTER SHEATH:

- 11.1 The PVC outer sheath with anti termite treatment shall be extruded over the armouring for multi core cables and single core cables.
- 11.2 The colour of the outer sheath shall be black.
- 11.3 The thickness of outer sheath shall be not less than the minimum value specified in column 5 of Table 8 of IS: 7098 (Part-I) 1988.

12 IDENTIFICATION:

- 12.1 The outer sheath shall have the following information embossed or indented on it, the manufacturer's name or trademark, the voltage grade, the year of manufacture and the letters "BESCOM". The identification shall repeat every 300/350 mm along the length of the cable.

13 CABLE DRUMS:

- 12.2 Cables shall be supplied in Non returnable wooden or steel drums of heavy construction and drum shall be properly seasoned, sound and free from defects, wood preservative shall be applied to the entire drum.
- 12.3 Standard length of each size of power cable to be supplied by the bidder shall be 500/1000 metres. The cable length per drum shall be 500/100 metres. The cable length power drum shall be subjected to a tolerance of $\pm 5\%$ of the standard drums lengths. Acceptance of smaller lengths of cables are subjected to approval of purchaser. Smaller lengths of less than 100 metres will not accepted.
- 12.4 A layer of waterproof paper shall be applied to the surface of the drums and over the outer most cable layer.
- 12.5 A clear space of atleast 40 mm shall be left between the cables and logging.
- 12.6 The cable drum shall carry KST marking with the following information stenciled on both sides of the drum. A tag containing the same information shall also be attached to the leading end of the cable.
- a. Reference to the Indian Standards.
 - b. Manufacturer's Name, Brand Name or Trade Name.
 - c. Purchase's name, contract No. and date.
 - d. Type of cable and voltage grade.
 - e. Number of cores.
 - f. Nominal cross section area of the conductor.
 - g. Cable code.
 - h. Length of the cable on the drum.
 - i. Number of lengths on drum.
 - j. Direction of rotation of drum (by means of an arrow).
 - k. Net and gross weight.
 - l. Country of manufacture.
 - m. Year of manufacture.

12.7 Packing shall be sturdy and adequate to protect the cables, from any injury due to mishandling or other conditions encountered during transportation, handling and storage. Both cables ends shall be sealed with good quality heat shrinkable caps so as to eliminate ingress of water during transportation and erection.

13 QUALITY ASSURANCE PLAN:

- 13.2 The successful bidder shall submit following information to the owner:
- 13.3 Test certificates of the raw materials and bought out accessories.
- 13.4 Statement giving list of important raw materials, their grades along with names of sub-suppliers for raw materials, list of standards according to which the raw materials are tested. List of tests normally carried out on raw materials in presence of bidder's representative.
- 13.5 List of manufacturing facilities available.
- 13.6 Level of automation achieved and lists of areas where manual processing exists.
- 13.7 List of areas in manufacturing process, where stage inspections are normally carried out for quality control and details of such tests and inspections.
- 13.8 List of testing equipments available with the bidder for final testing of equipment along with valid calibration reports.
- 13.9 The manufacture shall submit manufacturing quality plan (MPQ) for approval & the same shall be followed during manufacture and testing.
- 13.10 The successful bidder shall submit the routine test certificates of bought out raw material/accessories and central excise passes for raw material at the time of inspection.

14 Guarantee

- 14.1 The supplier of cables shall guarantee overall satisfactory performance of the cables.
- 14.2 At least three copies of type test reports shall be furnished. One Copy shall be returned duly certified by the owner, only after which the commercial production of the concerned material shall start.
- 14.3 Copies of acceptance test reports shall be furnished in at least Three (3) copies. One copy shall be returned duly certified by the Owner, only after which the materials shall be dispatched.
- 14.4 Record of routine test reports shall be maintained by the supplier at his works for periodic inspection by the owner's representative.
- 14.5 Test certificates of test during manufacture shall be maintained by the supplier. These shall be produced for verification as and when desired by the owner.

15 Inspection

- 15.1 The owner's representative shall at all times be entitled to have access to the works and all places of manufacture, where cable, and its component parts shall be manufactured and the representatives shall have full facilities for unrestricted inspection of the supplier's and sub-supplier's works, raw materials, manufacture of the material and for conducting necessary test as detailed herein.

- 15.2 The material for final inspection shall be offered by the supplier only under packed condition. The owner shall select samples at random from the packed lot for carrying out acceptance tests. The lot offered for inspection shall be homogenous and shall contain cables manufactured in 3-4 consecutive weeks.
- 15.3 The supplier shall keep the owner informed in advance of the time of starting and the progress of manufacture of material in their various stages so that arrangements could be made for inspection.
- 15.4 No material shall be dispatched from its point of manufacture before it has been satisfactory inspected and tested unless the inspection is waived off by the owner in writing. In the later case also the material shall be dispatched only after satisfactory testing specified here in has been completed.
- 15.5 The acceptance of any quantity of material shall in no way relieve the supplier of his responsibility for meeting all the requirements of the specifications and shall not prevent subsequent rejection, if such materials are later found to be defective.

- 16 **QUALITY CONTROL:**The Bidder shall furnish a complete and detailed quality plan for the manufacturing process of the cable. All raw materials shall conform to relevant applicable standards and tested for compliance to quality and requirement.

During the manufacturing process, at all stages, inspections shall be made to check the physical and dimensional parameters, for verification to compliance to the standards.

The Bidder shall arrange for inspection by the purchaser, during manufacture, if so desired by the purchaser to verify the quality control process of the Bidder.

17 **TYPE TESTS:**

17.1 Notwithstanding that type test have been conducted earlier, the successful bidder the each member of consortium shall conduct all type tests as per IS: 7098 (Part-I) 1988, with upto date amendments or equivalent international standard and supplies made only after approval of test reports from the purchaser.

17.2 All type tests, routine, acceptance test shall be conducted in the presence of the purchaser, representative.

17.3 The successful bidder shall give FIFTEEN days advance notice for inspections and witnessing of tests by the purchaser or his representative.

17.4 The owner reserves the right to get the cable type tested at any of the BESCO recognized testing house/laboratory at his own expense for any further tests to verify the compliance with the specifications and to reject the cables in case they are found not satisfying the qualifying requirements as per relevant standards.

17.5 The following type tests will be conducted on the cable as per IS: 7098 (Part-I).

- a) Test on conductor.
- b) Test on armor strip.
- c) Test for thickness of XLPE insulation and inner & outer sheaths.
- d) Physical test on XLPE insulation.
- e) Physical test on out sheath.
- f) Insulation resistance (volume resistivity) test.
- g) High voltage test.

h) Flammability test.

17.6 **ACCEPTANCE TEST:**

The sampling plan for acceptance test shall be as per IS: 7098 (Part-I) 1988.

17.7 The following shall constitute the acceptance test.

- a) Tensile test for aluminum.
- b) Wrapping test for aluminum.
- c) Conductor resistance test.
- d) Test for thickness of insulation.
- e) Test for thickness of inner and outer sheath.
- f) Hot-set test for insulation.
- g) Tensile strength and elongation at break test for insulation and sheaths.
- h) High voltage test.
- i) Insulation resistance (Volume resistivity) test.

18 **ROUTINE TEST:**

The following shall constitute routine tests:

- a) Conductor resistance test.
- b) High voltage test.

19 **SEALING OF CABLE ENDS ON DRUMS:**

19.01 The cable ends shall be sealed properly so that ingress of moisture is completely prevented.

19.02 The individual core endings shall be sealed effectively with water resistant compound applied over the core and provided with a heat shrinkable cap of sufficient length with adequate cushion space so that the conductor does not puncture the cap in case of movement of the core during unwinding or laying. Before sealing, the semi-conducting layer on the cores may be removed for about 2mm at each end, to facilitate checking the insulation resistance from one end, without removing the sealing cap at the other end.

19.03 The multi cores should have an overall heat shrinkable cap with adequate end clearance and sufficient cushioning to prevent puncturing of the overall sealing cap due to stretching of the cores. The sealing cap shall have sufficient mechanical strength and shall prevent ingress of moisture into the cable.

The ends of single core cables shall also be sealed on the same lines to prevent entry of moisture.

19.04 **CABLE LENGTHS:**

The cables shall be supplied in continuous lengths of 250-500 Mtrs in case of multi core cables with a tolerance of $\pm 5\%$ of drum length.

20 **GUARANTEED TECHNICAL PARTICULARS:** Guaranteed technical particulars of the cables to be supplied is enclosed.

21 **SCHEDULE OF DELIVERY:** The details regarding the delivery schedule are given in the Purchase Order/Dispatch instructions.

22 **DRAWING & LITERATURE:** The following shall be furnished along with the tender.

- a) Cross sectional drawings of the cables, giving dimensional details for each size of cable.
- b) An illustrated literature on the cable, giving technical information on current ratings, cable constants, short circuit ratings, derating factors for different types of installation, packing date, weights and other relevant information.

General Technical Parameters

Sl. No.	Particulars	unit	LT UG Cable
1	Cables		
	a) Name of manufacturer		
	b) Place of manufacture		
2	Cable Type		A2XFY
3	Applicable specification & standards voltage Grade		IS: 7098 (Part-1) /1.1kV
4	Suitable for effective Earth/Unearth system		
5	Permissible voltage & frequency variation for satisfactory operation		
6	Continuous current for standard conditon as per IS:		
	a) In air (45° C)	Amps	
	b) In Ground (30° C)	Amps	
	c) In Duct	Amps	
7	Conductor		
	a) Material		Aluminium conductor H2 OR H4 Grade
	c) Nominal cross sectional area	mm ²	
	b) Form of conductor		Strandard circular, class-2 as per IS:8130
	d) Number of Strands:	Nos	
	e) Diameter of Wire : mm before bunching	mm	
	f)Nominal continous operation	deg C	
	g)Short circuit condition	deg C	
	h) Maximum DC resistance of the conductor at 20° C	Ω/KM(CR value only for reference)
	i) Sampling batch for test		10% of ordered quantity
	j) Weight of the conductor	Kg/Km	
8	Process of Curing		
9	Insulation:		
	a) Material		XLPE

	b) Thickness of Insulation (Nom)	mm	
	c) Minimum thickness of insulation at any one point	mm	
	Hot Set test:		
	a) Elongation under load	%% minimum
	b) Maximum Permanent elongation after cooling	%% minimum
	c) Tensile Strength at break	N/mm ²% minimum
	d) Elongation at break	%% minimum
10	Inner Sheath		
	a) Material		PVC ST-2
	b) Whether Extruded		
	c) Min Thickness	mm	
	d) Colour of Inner Sheath		
11	Armouring		
	a) Material		Galvanized Steel Strip
	b) Type of armouring		
	c) Nominal Dimension of Armour wire	mm Dimension and % of Tolerance
	d) Minimum Number of Armour wire	 Numbers (Minimum)
	Armour Restivity (Max)	ohm cm	
	f) Mass of Zinc coating	gm/mm ²	
12	Outer Sheath		
	a) Material		PVC Compound Type ST-2
	b) Whether Extruded		
	c) Min. thickness of sheath	mm	
	d) Nominal Overall diameter of cable	mm	
	e) Thermal stability test for sheath	Minutes	
	colour		
13	Short circuit withstand capacity		
	a) Short Circuit withstand capacity	KA	
	b) Duration of short circuit	sec	one
14	AC resistance per core at operating temperature	ohm/km	
15	Reactance Ohm/Km	ohm/km	
16	Capicitance per core	µF/Km	
17	Allowable maximum conductor temperature when carrying current		
	Additional data		
19	Scheme of Identification		
20	Standard Packing Length and Tolerance	Mtrs	

21	Bending Radius	mm	
22	Scheme of identification of the cable		<p>manufacturer's name or trade mark, voltage grade, year of manufacture, project details and the letters "BESCOM". The identification shall repeat every 300/350 mm along with length of the cable.</p>

SECTION – 7

L.T. AERIAL BUNCHED CABLE & ITS ACCESSORIES

TECHNICAL SPECIFICATION FOR THE L.T AERIAL BUNCHED CABLES.

1.0 SCOPE:

- 1.1** This specification covers the design, manufacture, testing, inspection, packing, transportation and delivery of Crosslinked polyethylene (XLPE) insulated Aluminium Cables twisted over a central aluminium alloy insulated messenger wire (along with associated accessories) for use on LT overhead distribution feeders, supply of required accessories and installations. The cable should be suitable for use on three-phase AC (Earthed) system for rated voltage up to and including 1100 Volts and UV protected.
- 1.2** The cables should be suitable for use where the combination of ambient temperature and temperature rise due to load, including temperature exposure to direct sunlight results in conductor temperature not exceeding the following:

Table: 1

Type of Insulation	Normal continuous Operation	Short circuit Operation
Cross linked polyethylene	90° C	250° C

2.0 APPLICABLE STANDARDS:

The following standards with latest updates shall be applicable unless otherwise specified:

- a. IS:14255-1995 Aerial Bunched cable for working voltage up to and including 1100 Volts.
- b. IS:10810 (Series) – Methods of testing cables.
- c. IS : 8130 – 1984 for Aluminium conductors for insulated electric cables.
- d. IS : 398 (Part-IV) 1994 : For all Aluminium Alloy Conductors (AAC) for overhead transmission purposes.-PART 4 Aluminium alloy stranded Conductors (aluminium–magnesium-silicon type).
- e. IS:1885 (Part32) – Electro technical vocabulary: Part32 Electric Cables.
- f. IS: 6474 for insulation.

2.1 LT Aerial Bunched Cables:

Electrical Data:

- a. The rated voltage of the cables shall be 1.1kV.
- b. Highest system voltage: 1.2 kV.
- c. Test Voltage: i) 2.5 kV / 50 Hz/ 5 min for routine tests.
ii) 4 kV / 50 Hz/ 4 Hrs. for type tests.
- d. Max. short circuit current 1.0 kA for 1 Sec..
- e. Current carrying capacity at different ambient air temperatures of different sizes of phase conductors are tabulated at Table - 2.

THE CURRENT RATING AND SHORT CIRCUIT CAPACITY SHALL BE AS GIVEN BELOW:

Table - 2

3.0	Nominal sectional area	Current rating at 40°C (approx) Amps	Short Circuit capacity KA/1Sec.
	(mm ²)	XLPE	
	16	74	1.50
	25	100	2.35
	35	125	3.29
	50	150	4.70
	70	186	6.58
	95	230	8.93

GENERAL :

The insulated phase conductors shall be twisted around the insulated aluminium alloy messenger wire, which shall take all the mechanical stress. The messenger wire shall also serve as the earth-cum-neutral wire and shall be insulated.

3.1. CONDUCTORS :

3.1.1 The phase conductor shall be of Aluminium round, stranded and compacted aluminium wires confirming to H2 or H4 grade aluminium complying with requirements of IS:8130, the nominal cross sections and corresponding conductor diameter and number of wires etc., shall be as per clause 3.1.8 of this specification.

3.1.2 The phase and neutral conductors shall be insulated with black weather resistant Cross linked polyethylene insulation by extrusion process and suitable for 1100V insulation. The insulated conductors shall generally conform to the relevant IS standards as noted in clause 2.0 above. The thickness of insulation shall not exceed the limits specified in clause No.7.2, Table 4 and tolerance shall be as per clause No. 7.3 of IS:14255.

3.1.3 The power / outer –insulated neutral / street lighting conductors shall confirm to flexibility class 2 of IS 8130. The messenger cum neutral conductor or otherwise shall either be stranded circular or compacted circular type and shall have minimum of 7 strands. The surface of the conductor shall be smooth.

3.1.4 The messenger cum neutral conductor shall be heat treated aluminium magnesium – silicon alloy wires containing approx 0.5% magnesium and 0.5% silicon confirming to IS 398 Part-4 with latest revision thereof.

3.1.5 A protective barrier shall be applied between conductor and insulation. The barrier shall be compatible with insulating material and suitable for operating temperature of the cable.

3.1.6 The size of the street lighting conductor shall be 16sqmm.

3.1.7 DIMENSIONAL AND ELECTRICAL DATA.

3.1.8 The dimensional and electrical data for the cable and street lighting conductor shall be as given in Table 3, below. The resistance values are the maximum permissible.

Table 3:

Nominal sectional area (mm ²)	No of strands	Dia. Of compacted conductor (mm)	Approx. mass (Kg/km)	Max. DC resistance at 20C/KM	Insulation Thickness (mm)
(1)	(2)	(3)	(4)	(5)	(6)
16	6	4.4	42	1.91	1.2
25	6	5.5	65	1.20	1.2
35	6	6.8	95	0.868	1.2
50	6	7.9	127	0.641	1.5
70	12	9.6	184	0.443	1.5
95	15	11.3	254	0.320	1.5
120	15	12.9	315	0.253	1.5

Note: a).The Resistance value given in col. 5 are max. permissible.
b).Tolerance of + 5% is allowable on diameter shown in col.3

3.1.9 Phase Identification :

Durable and clearly visible longitudinal ridges shall be provided as follows on each insulated conductors as indicated below for identification of phases.

For phase conductors (3 Core Cable) = R, Y, B
For Street Light Conductor = SL
For Neutral/Messenger Conductor = N

Approx. ridge dimensions are:

- Width = 1.00 mm
- Height = 0.4 mm
- Distance between consecutive ridges = 2.7 mm.

4.0 INSULATED MESSENGER (NEUTRAL CONDUCTOR) :

4.1.1 The messenger shall be an All Aluminium Alloy conductor composed of 7 Wires each of nominal dia 3.55 mm Dia drawn from rod, which is manufactured in a continuous casting and rolling procedure. The properties for the individual wires before stranding shall be.

- Tensile strength not less than 294 N/mm²
- Elongation on 200 mm not less than 4%.
- Resistivity at 20 Deg. C not exceeding 0.0328 ohm Sq.mm/m
- Density at 20 Deg. C 2.7 Kg/cubic – m.

4.1.2 No joints are allowed in the messenger except those made on the base rod or wire before final drawing. The messenger shall be round, stranded and compacted to have smooth round surface.

4.1.3 The messenger takes all the mechanical stress and also serves as neutral conductor. The size and requirement of messenger conductor for minimum DC resistance and minimum

breaking load shall be as per clause No.6.5 and Table 4 of IS: 14255.

Table-4

Sl. No.	Nominal Cross Sectional Area of Conductor mm ²	Messenger Conductor		
		Nominal Cross Sectional Area mm ²	Maximum DC Resistance at 20° C ohm/km	Minimum Breaking Load kN
1.	16	25	1.38	7.0
2.	25	25	1.38	7.0
3.	35	25	1.38	7.0
4.	50	35	0.986	9.8
5.	70	50	0.689	14.0
6.	95	70	0.492	19.7

Note: While the limiting values in Col. 4 & 5 are to be guaranteed, a tolerance of +5% will be permissible on values in Col.2.

5.0 **DESIGN:**

5.1.1 The cable consists of three phase aluminium conductors and one street light aluminium conductor with black weather resistant special high density Cross linked polyethylene insulation, shall be twisted around a insulated all aluminium alloy messenger which is also the neutral conductor without fillers with lay not exceeding 35 times the diameter of the insulated phase conductor.

5.1.2 The thickness at any place may be less than the specified average value, provided that the difference does not exceed 0.1 mm + 0.1(ti) of the specified average value in clause No.7.2, Table 5 and tolerance shall be as per clause No. 7.3 of IS:14255.

5.1.3. The insulation shall be applied that fits closely on the conductor (or barrier, if any) and it shall be possible to remove it without damaging the conductor. Further, for the thickness of insulation, six measurements are made radially on a piece of insulation, as far as possible equally spaced around the circumference but not on the ridges.

5.1.4. The insulation shall be black weather resistant suitable for 1100V and confirming to IS:6474.

5.1.5. The properties of XLPE insulation shall confirm to clause No. 5.1, Table 1 and 2 of IS: 14255.

5.1.6. The insulation shall be XLPE of nominal thickness and its properties shall confirm to IS: 7098 & IS: 6474. The black carbon content in XLPE shall be 2% only.

6.0. **Designation and parameters of the Finished Cables:**

The designation and parameters of the finished cables shall be as given in the Table 5 below. The first part of the designation refers to the Number & size (cross sectional area in sq.mm) of the Phase Conductor, the second part refers to the (cross sectional area in sq.mm) of the Messenger.

Table: 5: Sizes

Description of Sizes	Complete Cable	Bunched
	Approx. Overall dia. (mm)	Approx. Cable mass (Kg/Km)

3x16+1x16+1x25	19	310
3x25+1x16+1x25	22	390
3x35+1x16+1x25	24	490
3x50+1x16+1x35	32	640
3x70+1x16+1x50	34	890
3x95+1x16+1x70	39	1180
3x95+1x25+1x70	41	1260
3x95+1x35+1x70	43	1360
3x120+1x16+1x95	42	1430

7.0 TYPE TESTS ON LT AB CABLE:

Unless otherwise stated in this specification, the type tests and routine/acceptance tests shall be carried out in accordance with the appropriate clauses of IS:14255 and IS:10810.

8.0 TYPE TESTS AS PER CL.10.1 AND 11.4 OF IS:14255/1995 :

- a) Tests on phase/street light conductor
 - i) Tensile Test
 - ii) Wrapping Test
 - iii) Resistance Test
- b) Tests on messenger conductor
 - i) Breaking Load
 - ii) Elongation Test
 - iii) Resistance Test
- c) Physical test for XLPE Insulation:
 - i) Tensile strength and elongation at break
 - ii) Ageing in Air oven
 - iii) Hot set test
 - iv) Shrinkage test
 - v) Water absorption (Gravimetric)
 - vi) Carbon black: content dispersion
- d) Test for thickness of insulation
- e) Insulation resistance (volume resistivity)
- f) High voltage test
- g) Bending test on complete cable
- h) Ultra violet test on cable to withstand ultra violet radiation.

8.1 ACCEPTABLE as per Cl.10.2 of IS: 14255/1995 :

- a. Tensile tests for phase/street light conductor.
- b. Wrapping Test for phase/street light conductor.
- c. Breaking load test for messenger conductor.
- d. Elongation test for messenger conductor.
- e. Conductor resistance test.
- f. Test for thickness of insulation.
- g. Tensile strength and elongation at break
- h. Hot set Test for XLPE Insulation.
- i. Insulation resistance test.
- j. High voltage test
- k. High Voltage Test on DRUM, immersed in water & apply test voltage 3.5kV AC for 5 min.

- l. Weather ability test for withstanding weather conditions.
- m. Adherence test on insulated messenger wire

8.2 ROUTINE TESTS as per Cl.10.3 of IS: 14255/1995:

- a. Conductor Resistance Test.
- b. High Voltage Test

8.3 OPTIONAL TEST: This test to be insisted as part of Acceptance tests during inspection.

Bending Test on the Complete Cable :

The test shall be performed on a sample of complete cable. The sample shall be bent around a test mandrel at room temperature for at least one complete turn. It shall then be unwound and the process shall be repeated after turning the sample around its axis 180 Deg. The cycle of these operations shall then be repeated more. The diameter of the mandrel shall be $10(D + d)$.

Where D= actual diameter of the cable (i.e., minimum circumscribing circle diameter in mm)
d= actual diameter of the conductor in mm. No cracks visible to the naked eye are allowed.

Type Test Report:

The bidder shall submit type test reports for the particular sizes asked in the tender for the type tests carried out from NABL accredited Laboratory and the reports should not be older than 5 years as on the date of opening of tender. The bid not carrying valid type test reports will not be considered for evaluation.

8.4 **SAMPLING OF CABLES:**

In any consignment the cables of the same size manufactured under essentially similar conditions of production shall be grouped together to constitute a lot. Samples shall be taken and tested from each lot for ascertaining the conformity of the lot to the requirement of the specification. The number of drums(n) to be selected from the lot of drums(N) of consignment of cables shall be in accordance with column 2 and 1 of following table:

Table 6: Number of Drums to be selected Sampling and permissible Number of Defectives.

Number of Drums in the Lot (1) N	Number of Drums to be Taken as Sample (2) n	Permissible Number of Defectives (3) a
Upto 50	2	0
51 to 100	5	0
101 to 300	13	0
301 to 500	20	1
501 and above	32	2

The sample shall be taken at random. In order to ensure randomness of selection, random number table shall be used as per IS 4905.

Number of tests and criteria for conformity: Suitable length of test sample shall be taken from each of the drums selected. The test sample shall be subjected each of the acceptance test. A test sample is defective if it fails in any of the acceptance test. If the number of defectives is less than or equal to the corresponding permissible defective(a) given in the table 9 the lot shall be declared as conforming to the requirements of acceptance test, or otherwise not.

9.0. PACKING AND MARKING :

The Cable shall be wound on non-returnable wooden drums conforming to IS: 10418 /1982 with latest amendment thereof. The ends of the cable shall be sealed by means of non-hygroscopic sealing materials. The drum shall be marked with the following.

- a. Manufacturer's Name or Trade Mark.
- b. Type of cable and voltage grade.
- c. Drum number or identification number.
- d. Number of cores and size of cable.
- e. Number and length of pieces of cable in each drum.
- f. Gross / Net mass of the cable.
- g. Direction of rotation of drum. (By means of an arrow).

9.1 The drums shall be of such construction as to assure delivery of conductor in the field free from displacement and damaged and should be able to withstand all stresses due to handling and the stringing operation so that cable surface is not dented, scratched or damaged in any way during transport and erection. The cable shall be properly lagged on the drums. The cable drum shall be suitable for wheel mounting.

9.2 The min. drum length of cable shall be 500 mtrs, the tolerance $\pm 5\%$.

9.3 MARKING OF CABLE:

All the cables shall have the following marking embossed on the insulated phase conductors for identification: letters **BESCOM; Ref P.O & Date** in addition to manufacturer's name or trade mark year of manufacture at regular intervals of not more than one meter. The cables with cross linked polyethylene insulation shall be identified throughout the length of the cable by the legend 'XLPE 90'.

10.0 QUALITY ASSURANCE PLAN

10.1 The successful bidder shall submit following information to the owner.

10.2 Test certificates of the raw materials and bought out accessories.

10.3 Statement giving list of important raw materials, their grades along with names of sub-suppliers for raw materials, list of standards according to which the raw materials are tested. List of tests normally carried out on raw materials in presence of bidder's representative.

10.4 List of manufacturing facilities available

10.5 Level of automation achieved and lists of areas where manual processing exists.

10.6 List of areas in manufacturing process, where stage inspections are normally carried out for quality control and details of such tests and inspection.

10.7 List of testing equipments available with the bidder for final testing of equipment along with valid calibration reports.

10.8 The manufacture shall submit manufacturing quality plan (MPQ) for approval & the same shall be followed during manufacture and testing.

10.9 The successful bidder shall submit the routine test certificates of bought out raw material/accessories and central excise passes for raw material at the time of inspection.

11.0 GUARANTEE:

The supplier of AB Cable shall guarantee overall satisfactory performance for minimum period of 5 years.

11.1 At least three copies of latest type test reports shall be furnished. One copy shall be returned duly certified by the owner, only after cable shall be supplied.

11.2 Copies of acceptance test reports shall be furnished in at least three sets. One copy shall be returned duly certified by the owner, only after which the materials shall be dispatched.

11.3 Record of routine/internal test reports shall be maintained by the supplier at his works for periodic inspection by the owner's representative.

11.4 Test certificates of test during manufacture shall be maintained by the supplier. These shall be produced for verification as and when desired by the owner.

12.0 INSPECTION:

12.1 The owner's representative shall at all times be entitled to have access to the works and all places of manufacture, where AB Cables and its component parts shall be manufactured and the representatives shall have full facilities for unrestricted inspection of the supplier's and sub-supplier's works, raw materials, manufacture of the material and for conducting necessary test as detailed herein.

12.2 The material for final inspection shall be offered by the supplier only under packed condition. The owner shall select samples at random from the packed lot for carrying out acceptance tests. The lot offered for inspection shall be homogenous and shall contain AB Cables manufactured in 3-4 consecutive weeks.

12.3 The supplier shall keep the owner informed in advance of the time of starting and the progress of manufacture of material in their various stages so that arrangements could be made for inspection.

12.4 No material shall be dispatched from its point of manufacture before it has been satisfactory inspected and tested unless the inspection is waived off by the owner in writing. In the later case also the material shall be dispatched only after satisfactory testing specified here in has been completed.

12.5 The acceptance of any quantity of material shall in no way relieve the supplier of his responsibility for meeting all the requirements of the specifications and shall not prevent subsequent rejection, if such materials are later found to be defective.

12.6 The prospective bidders should furnish the GTP of AB Cables

1.1kV LT AB Cable as per IS 14255:1995 with high quality class XLPE Insulation		
SL. No.	Particulars	
	Name of the Manufacture	
1	Standard/specification	
2	Size of Aerial Bunched cable	
3	CONDCUTOR	
3.1	phase conductor - Alu portion	
	i) Material of conductor	Aluminium wire(H2 or H4)
	ii) Applicable standard	IS 8130
	iii) Nominal area of cross-section of bare conductor(Sq.mm)	
	iv) No. of strands	
	v) Nominal diameter of strand(mm)	
	vi) Maximum DC resistance of the conductor at 20°C
	vii) Diameter of bare conductor (mm)	
3.2	Street Light conductor-Alum. Portion	
	i) Material of conductor	Aluminium Alloy(AAAC)
	ii) Applicable standard	IS 398 Part IV- 1994
	iii) Nominal area of cross-section of bare conductor(Sq.mm)	
	iv) No. of strands	
	v) No. diameter of strand in mm	
	vi) Maximum DC resistance of the conductor at 20°C
	vii) Diameter of bare conductor (mm)	
3.3	Messenger/actual conductor-AAA portion	
	i) Material of conductor	
	ii) Applicable standard	
	iii) Nominal area of cross-section of bare conductor(Sq.mm)	
	iv) Number of strands	
	v) Nominal diameter of strand(mm)	
	vi) Maximum DC resistance of the conductor at 20°C	
	vii) Diameter of bare conductor (mm)	
	viii) Lay Ratio	
	ix) Tensile strength (min)/breaking load (KN)	
4	Sampling batch for test	

5	Phase conductor - Insulation	
	i) Material	
	ii) Insulation Thickness(mm)	
5.1	Street Light conductor - Insulation	
	i) Material	
	ii) Insulation Thickness(mm)	
5.2	Messenger/neutral- Insulation	
	i) Material	
	ii) Insulation Thickness(mm)	
6	Complete AB cable	
	i) Code or method of cable identification	Phase conductors in Black color, Ridges to be provided as 1,2,3 for identification as per clause no.8 of IS 14255/1995
7	Tests on XLPE Insulation	
7.1	Hot set test	
	a) (Max. elongation under load)	
	b) (Max.permanent Elongation After cooling)	
7.2	a) Min Tensile Strength	
	b) Min Elongation	
7.3	Water Absorption test :a) Max. water absorbed	
7.4	Carbon Black Content Shall be ranging	
8	Total Weight of the conductor (Aluminium and Aluminium Alloy)	
9	Electrical Data:	
	i) Short Circuit current for 1 Sec. Max (KA)	
	ii) Current carrying capacity (amps) at various ambient temp.deg.of 10°C, 20°C, 30°C, 40°C & 50°C	
10	BENDING RADIUS OF CABLE:	12D

11	Scheme of the identification of the cable	<p>marking shall be embossed on the insulated phase conductors for identification: letters BESCOM Project/Phase/Agency Name in addition to manufacturer's name or trade mark year of manufacture at regular intervals of not more than one meter. The cables with cross linked polyethylene insulation shall be identified throughout the length of the cable by the legend 'XLPE 90'.</p>
----	--	--

TECHNICAL SPECIFICATION FOR INSULATION PIERCING CONNECTORS, ANCHOR (DEAD END) & SUSPENSION ACCESSORIES & OTHER ACCESSORIES FOR AERIAL BUNCHED CABLES FOR WORKING VOLTAGE UPTO AND INCLUDING 1100 VOLTS.

1.0 SCOPE

This specification covers the design, manufacture, assembly, testing and supply of Accessories for anchoring, suspending & making connections to Aerial Bunched Cables rated 1100 volts and insulated with cross-linked polyethylene.

2.0 STANDARD

The design, performance and test requirements shall confirm to this specification and the following standards. However, in case of any conflict, the requirements of this specification shall prevail.

- 1.0 NFC 33-020 Insulation Piercing Connectors
- 2.0 NFC 33-004 Electrical Ageing Test
- 3.0 NFC 33-040 Suspension Equipments
- 4.0 NFC 33-041 Anchoring Devices
- 5.0 IS 14255 LV Aerial Bunched Cables

The Devices shall also be compatible with the cables of sizes & dimensions as defined in the Cable Specifications for the cables with which they are intended to be used.

3.0 CABLE DATA

The standard sizes and characteristics of the phase and street lighting conductors, messenger wires shall be as specified in IS: 14255-1995.

The Accessories of LT XLPE Insulated Aerial Bunched Cables (ABC) with insulated messenger cum neutral are specified below:

- a) The ABC accessories should be of proven design with minimum 2 years record of satisfactory operation with a major utility. Order copies and Performance Certificates should be enclosed with the offer.
- b) Since ABC accessories are to be used with insulated neutral-cum-messenger, their design should incorporate specific features to prevent damage to the insulation which meeting the required electrical, mechanical & thermal requirements.
- c) All mechanical, electrical & thermal ratings should meet or exceed 90% of the corresponding ratings of the cable, or the values specified herein, whichever are more stringent.
- d) The accessories should provide "Double Insulation" so that a single point failure of insulation will not result in the system tripping.

4.0 THE ABC ACCESSORIES

The ABC Accessories shall consist of the following:

a)	Insulation Piercing Connectors (IPC)	:	For making tap-off/branch connectors/service connector to an ABC line.
b)	Anchoring Assembly (AA)	:	For fitting onto a pole for anchoring the end of a length of ABC, or for a major change in direction.
c)	Suspension Assembly (SA)	:	For supporting a length of ABC at an intermediate pole in a length, with small angle of deviation.
d)	Service clamp (SC)	:	For anchor Insulated service lines (armoured or unarmoured)
e)	Transformer Connections	:	For connection to the transformer bushing.
f)	Junction Sleeves	:	For Phases, neutral messengers & Street lighting conductor.
g)	ABC Service Main Distribution Box	:	For Distribution of multiple no. of Service Connections from Main AB cable.
h)	Stainless steel strap & buckles	:	For fixing clamps to pole through aluminium bracket for dead end & suspension clamps.

5.0 Insulation Piercing Connectors (IPC)

Insulation Piercing Connectors (IPC) are used for making Tee/Tap-off/ Service connectors to an ABC/Bare Overhead Line. Insulation Piercing Connectors are designed to make a connection between the uncut main conductor and a branch cable conductor without having to strip either cable to expose the conductor instead the tightening action of the IPC will first pierce the Insulation, then make good electrical contact between the main end and branch conductor while simultaneously insulating and sealing the connection.

5.1 Constructional Features of IPC.

1. The housing shall be made entirely of mechanical and weather resistant plastic insulation material and no metallic part outside the housing is acceptable except for the tightening bolt.
2. Any metallic part that is exposed must not be capable of carrying a potential during or after connector installation.
3. Screws or nuts assigned for fitting with IPC (Insulating Piercing connector), must be fitted with torque limiting shear heads to prevent over tightening or under tightening (min & max torque values to be specified by Manufacturer).
4. The IPC must perform piercing and connection on Main and Branch cable simultaneously using single bolt for tightening as multiple bolts do not ensure even tightening.
5. The IPCs shall be water proof and the water tightness shall be ensured by appropriate elastomer materials and not by grease, gel or paste alone.
6. Design of IPC should be such as to not cause damage to insulation of adjacent conductors due to vibration and relative movement during service.
7. All the metallic parts of the connector should be corrosion resistant and there should not be any appreciable change in contact resistance & temperature after overloads & load cycling.
 - The contact plates should be made of tinned copper/aluminum alloy.
 - Connector teeth should be factory greased & sealed to retard water or moisture ingress & corrosion.
 - The Insulation material should be made of weather & UV resistant reinforced polymer.
 - The outer metallic part should have potential free tightening bolts to allow safe installation on live lines.

5.2 Mechanical Tightening and Electrical Continuity:

Connectors shall be tightened up to 70% of the minimum torque indicated by the Manufacturer. At this torque electrical contact should have occurred between conductors to be joined. Then connectors shall be tightened up to the breakdown of the shear heads and lastly, upto 1.5 times the maximum torque indicated by the manufacturer, and there shall be no breakdown of any part of the connector or the core conductor.

Maximum rated torque shall not exceed 20 N.m for conductor <95 sq.mm and 30 for >95 but <150 Sq.mm. Tightening screws shall have hex. Heads of 10 mm, 13 mm or 17 mm only.

5.3 Effect of Tightening on Main Core of IPC:

The connector shall be fitted approx. at the center of the main core, which is secure between two anchoring points 0.5 mtr. To 1.5 mtr. apart. At the time of fitting the connectors, the main core shall be under longitudinal tension at 20% of the load indicated in Table-1:

Table – 1

Nominal Cross – section (Sq mm.)	Tensile Strength (Newton)
16	1200

25	1800
35	2500
50	3500
70	5000
150	10000

Tensile strain shall be increased to the full value indicated in the Table 1 and held minute. There should be no breakdown of the core conductor.

5.4 Effect of Tightening on Branch Core of IPC

Test specimen shall be made up as in clause 5.3 except that this shall be do the smallest cross sections of main and branch conductors within its range.

An increasing tensile load shall be applied to the Branch Conductor along the axis of the recess for the Branch cable. Load shall increase at 100 – 500 N/minute until it reaches the value specified in the Table 2 and maintained for 1 minute. No slippage or breaking of conductor shall occur.

Table – 2

Nominal Cross – section (Sq mm.)	Tensile Strength (Newton)
16(Alu)	290
25	450
35 & above	500

5.5 Dielectric & Water Tightness Test of IPC

1. The connector is tightened up to the minimum torque indicated by the manufacturer.
2. Connectors are mounted on
 - Minimum cross section of main core.
 - Maximum cross section of main core.
3. In each case Branch is of minimum cross section.
4. Protection caps for the branch cable are to be used in accordance with the requirements of clause 5.1.7. An additional water tight cap of any design may be used to seal one end of the main cable if it is immersed under water. No additional gel or any protection is to be provided while installing connector.
5. The entire assembly shall be immersed at a depth of approx. 30 cms. For 30 minutes with the free ends of main and branch cable out of water.
6. An AC voltage of 6 kV shall be applied between the water bath and each of the cores in turn for 1 minute. There shall be no flashover or electrical tripping with a trip setting of 10 mA + 0.5mA.

5.6 Electrical & Ageing Test of IPC.

1. Any one of the two test configurations are used according to Table 3 with the Connections tightened to the minimum torque specified by their manufacturers and resistance recorded.

Table – 3

Configuration	Main core cross section	Branch core cross section Tensile Strength (K.N)
1st Configuration	Minimum main	Maximum branch
2nd Configuration	Maximum main	Maximum branch

2. The configurations are subjected to 200 heat cycles by injecting suitable current into them. In each cycle the temperature of the branch conductor shall be raised from ambient to 120 + 5°C as, measured by a thermocouple.
3. The duration of each heating cycle is chosen to maintain a sufficiently steady temperature of 120 + 5°C for 15 minutes. The duration of each cooling cycle is chosen to bring the conductor temperature to within 2°C of ambient. The test configuration shall have 6 IPC connected in 3 parallel loops of main and branch with three such loops being in series. The initial scatter between the six value for connector resistance (one value for each connector) at cycle zero shall be lower than or equal to 0.30
4. Nominal heating current is indicated in the Table-4. It shall be permissible to accelerate the temperature rise by using a current up to 1.5 times the nominal current and to accelerate the cooling period by use of a fan or air blower.

Table – 4

Nominal Cross – section (sq. mm.)	Nominal Heating Current (A)
16	102
25	139
35	175
50	225
70	283
95	350
120	412
150	480
185	545
240	670

5. The over current test of Clause 5.1.9 shall be done after 50 cycles if the connector is a safety connector designed to ground a phase connector while the line is being worked on.
6. At the end of the 200 cycles the resistance shall again be measured. It shall not differ from the initial value by more than 12%. For each connector, maximum and minimum of difference between reference core temperature and connector temperature shall be within ± 10 C of mean of difference between the reference core temperature and connector temperature. Maximum temperature of any connector should not exceed reference core temperature.

5.7 Over Current Test of IPC (as applicable to size):

Over current test is required to establish the performance of Safety Connectors that are intended to provide a safe path to ground for the phases while the line is de-energized for working. It establishes the performance of the connector under short term over load conditions. Over Current Test of IPC: This test is applicable for network connectors since it may be subjected to overloads or short circuits which are not restricted by protection devices.

- After the first 50 cycles of clause 5.6.2, the connectors are subjected to 4 over currents of 1 sec duration each.
- The conductor temperature at the start of the over current test should be not more than 35OC.
- Current density during over current shall be 100 A/Sq mm for Aluminum and 95 A/Sq mm. for Aluminum – Alloy Conductor.
- Variation in time of over current is permissible between 0.85 sec & 1.15 sec., provided if maintains the relationship $I^2t = K$ where,

I = rms value of over current in Amps.

t = time in seconds

K = Constant

- After the over current test the electrical ageing test shall be resumed.

6.0 Anchoring Clamp for Insulated Messenger:

The clamps should be designed to Anchor LT-AB cable with insulated messenger. The clamp should consist of an Aluminium alloy corrosion resistant casted body or climatically resistant

polymer material, bail of stainless steel and self adjusting plastic wedges which shall anchor/hold the neutral messenger without damaging the insulation.

- No losable part in the process of clamping arrangement
- The clamp should conform to the standard NFC 33041 and 33042 or equivalent I.S. if any.
- The clamp body should be made of corrosion resistant Aluminium alloy or climatically resistant polymer material, bail should be of stainless steel and wedges should be weather and UV resistant polymer. λ Ultimate tensile strength of the clamp should not be less than 15 kN for 50/70 sq.mm insulated messenger wire / 10 KN for 25/35 sq.mm insulated messenger wire.
- Slip load of the clamp should not be less than the values specified in clause 4.0.c and Table 6 of the standard for various sizes.

Anchoring assemblies are used to firmly attach the messenger of ABC to a support and transmit the mechanical tension.

- at the end of a run or to the supporting structures
- at a major change in direction.

6.1 Each **Anchoring Assembly** shall include.

- One number tension bracket.
- One number wedge type tension clamp
- Flexible Rope for fixing tension clamp to bracket.

Anchoring assemblies shall be supplied in sets to ensure compatibility of the materials against corrosion or wear of moving parts.

6.2 **Tension Bracket of AA**

The tension bracket shall be made out of a single piece of Aluminium alloy suitable for attachment to a pole either by

- b) 16mm (galvanized) steel bolt (s) or
- c) Two stainless Steel straps of $20 \pm 0.2 \times 0.7 \pm 0.5$ mm and buckle with aluminums bracket. The SS strap shall have tensile strength of 7.5KN min, elongation 30% min, finish of 2B, and of corrosion & wear resistant stainless-steel material.

Material = SS202, Raw material Composition tolerance= As per ASTM 'A480'

The tension bracket should be designed to ensure the Flexible rope cannot slip out at any angle. The inner side of the bracket should be min 100 mm from the surface of the pole. (NFC-33-041)

The tension bracket should be rated and tested for the loads specified in Table-5. The load shall be applied at an angle of 45° from the normal to the surface of mounting of the bracket.

The bracket design should be in such a way that minimum distance between the pole and the anchoring clamp fixing point shall be 100 ± 20 mm.

The Rope should be of length to maintain at least 150mm distance between bracket and body clamp and shall have sufficient mechanical strength to withstand the mechanical test for the complete assembly tests in this specification.

Table – 5

Conductor Size (Sq mm.)	Rating	Load deformation for <10mm (Newtons)	Load for deformation <30mm & no-break (Newtons)
25-35	1500 Kg	12,000	15,000
50-95	2000 Kg	15,600	19,500

6.3 Flexible Rope of AA

1. The Anchoring assembly shall be supplied with a stainless-steel flexible Rope to connect the Tension Clamp to the Tension Bracket.
2. The rope should have sufficient flexibility to ease the torsional movement of the ABC System.
3. The Rope should be pre-fitted with compression type end fittings to secure the tension clamp or through any other suitable means.
4. A wear resistant moveable saddle should be un-loosably fitted on the Rope to prevent abrasion at the point of fitting into the tension bracket.
5. Rope should have sufficient mechanical strength to withstand the mechanical test for the complete assembly tests in this specification.

6.4 Wedge Type Tension Clamp of AA

1. Wedge type clamps shall be used for clamping the messenger without damaging the insulation.
2. The clamp shall be capable of clamping an uncut messenger so that it can continue without break to the connecting point or next span.
3. The clamp shall be fully insulating type of mechanical and weather resisting thermoplastic.
4. No bolts or loose parts are allowed as part of the Clamping system.
5. No tools shall be needed for fitting the messenger into the clamp.
6. The clamp shall be self tightening and capable of holding without slippage the load specified in the Table-6.

Table – 6

Conductor size		Rating (kg)	T start (1Minute) (Newtons)	T final (1Minute) (Newtons)
Sq mm	Dia (mm)			
25-35	8-11	1000	8,000	10,000
50-70	12-14	1500	12,000	15,000
70-95	13.5-16	2000	12,000	15,000

After fitting the insulated messenger in the clamp, load T start will be held for 1 minute & then load increased to T final at rate between 5000 – 7,500 N/mtr. In each case there shall be no breakdown of any part of clamp and slippage of messenger in relation to the clamp.

6.5 Voltage Test on Clamp of AA

- Voltage test is carried out on anchor clamps to ensure no damage is caused to the insulated messenger.
- A conductive rod of dia. corresponding to the average dia. that can be accommodated in the clamp is fitted into the clamp, protruding by approx. 50mm at each end of the tightening piece.
- The rod and clamp is subjected to tensile load as stated in Table 7 below when fixed to a support in its normal manner.

Table – 7

Conductor Size		Normal Rating (kg)	Load Applied (N)
Sq mm	Dia (mm)		
25-35	8-11	1000	2000
50-70	12-14	1500	4000
70-95	13.5-16	2000	6000

- A power frequency voltage of 6 kV is applied for 1 minute between the rod and conductive part of the clamp, or fixation point in absence of conductive part.
- No breakdown or flashover shall occur. There shall be no tripping due to leakage with a setting of 10 + 0.5 mA.

6.6 Endurance under Mechanical & Thermal Stress of AA

1. Test is done on clamp with largest cable in its range and also to comply with loads specified in table 8 of the standard.
2. A neutral messenger is fitted between two anchor clamps, with clamp spacing approx. 5 mtr. & 1 mtr. Of messenger protruding from the end. Marks are made to enable measurement of slippage.
3. The sample is subjected to 500 cycles of 90 minutes each as described below
4. Messenger temperature is raised by passing an AC current to 60 +3OC within 15 minutes. This temperature is maintained for at least 30 minutes to give a total heating period of 45 mts. Per cycle.
5. Messenger is allowed to cool naturally to ambient for further 45 minutes to complete 90mts. Cycle time.
6. Mechanical load is applied during the cycle as per table 8 below. Load F1 is applied throughout the cycle, except for a short period of 5 sec. to 60 sec. when it is gradually increased from F1 to F2 at any time during the last 15 minutes of the 90 minute cycle.

Table – 8

Conductor size		Rating (kg)	F1 (Newtons)	F2 (Newtons)
Sq mm	Dia (mm)			
25-35	8-11	1000	2,200	5,000
50-70	12-14	1500	4,000	7,500
70-95	13.5-16	2000	4,500	10,000

7. There should be no slippage greater than 4 mm after 2 cycles or greater than 8 mm after 500 cycles.
8. Voltage test is done at the end of the 500 cycles by immersing the test specimen of neutral messenger and clamps in water of resistivity not less than 200 Ohm mtr. For 30 minutes.
9. A voltage of 10 kV ac is applied for 1 minute between messenger and water bath using a trip setting of 10 + 0.5 am. There should be no breakdown or tripping.

7.0 Suspension clamp for insulated neutral messenger:

The clamp should be designed to hang L.T – AB cable with insulated neutral messengers. The neutral messengers should be fixed by an adjustable grip device. A movable link should allow longitudinal and transversal movement of the clamp body.

- No losable part in the process of clamping arrangement.
- The clamp should conform to the standard NFC 33040 or equivalent I.S, if any.
- The clamp and the link made of Polymer should provide an additional insulation between the cable and the pole.
- The clamps and movable links should be made of weather and UV resistant glass fibre reinforced polymer.
- Clamps should be fixed with pole by eye hook / aluminum bracket by means of movable link securely fitted. Bracket should be made of corrosion resistant aluminum alloy. Or, Clamp should be fixed with pole by SS bands plus bracket.
- Ultimate tensile strength of the clamp should not be less than 15 KN for 50/70 sq.mm. Insulated messenger wire 10 KN for 25/35 sq.mm. insulated messenger wire.

Suspension Assembly is used for supporting an ABC by installation on the messenger at an intermediate point of support such as a pole. It can accommodate small angles of deviation up to 30°.

Each Suspension Assembly shall consist of:

- One number Suspension Bracket.
- One number moveable (articulated) connecting link.
- One number Suspension Clamp.

Suspension Assemblies shall be supplied in sets to ensure compatibility of the materials against corrosion or wear of rotating/moving parts.

7.1 Suspension Bracket of SA

The Suspension Bracket shall be made from single piece aluminum alloy suitable for attachment to a pole by either.

- a) 16 mm galvanized steel bolt or
- b) Two stainless steel straps.

The Suspension Bracket shall be provided with an upper bulge to prevent the clamp from turning over on the Bracket for more than 45° from the horizontal or to within less than 60 mm from the pole / fixing structure.

The Suspension Bracket should be so designed to ensure that the articulated link cannot slip out of it.

Suspension Brackets shall be designed to withstand a load applied at the anchoring point of the movable link as per Table – 9 below without deformation of more than 10mm or breakdown at 330 below horizontal (there should be no longitudinal component of load parallel to the plane of fixing).

Table – 9

Conductor Size		Normal Rating (kg)	Load Applied (N)
Sq mm	Dia (mm)		
25-54	8-15	1500	12,500
70-95	13-17	2000	14,000

7.2 Movable (Articulated) Link of SA

Movable Links are used between the Suspension Bracket and Suspension Clamp to allow a degree of movement and flexibility between the two.

Moveable Links should be made fully of insulating type of mechanical and weather resistant thermoplastic. A metallic wear resistant ring should however be fitted at point of contact between the Suspension Bracket and the movable link.

The Movable link should be unloosably fitted to the Bracket and the Clamp.

7.3 Suspension Clamp of SA

- Suspension Clamps are used for locking the messenger of the ABC bundle without damaging the insulation or allowing the messenger to become dismounted from the fitting.
- The Suspension Clamp shall accommodate messenger wires from 25 -54 sqmm and 70-95 sq.mm as in Table 9 above.
- The Suspension Clamp shall be made fully of insulating type of mechanically strong and weather resistant plastic.
- Bolts should not be used for clamping / locking the messenger in the Clamp.
- There shall be no losable parts in the Suspension clamp.
- The Suspension Clamp should be unloosably fitted to the rest of the Suspension Assembly.

7.4 Mechanical Test on Clamp of SA

The Sub Assembly shall be subjected to a vertical load applied as per drawing in accordance with Table-10. There shall be no breakdown or permanent deformation at load T initial for 1 minute or when the load is increased to T final and released.

Table – 10

Conductor size		Rating (kg)	T start (1Minute) (Newtons)	T final (1Minute) (Newtons)
Sq mm	Dia (mm)			
25-54	8-15	1500	9,600	12,000
70-95	13-17	2000	12,800	16,000

Fig A

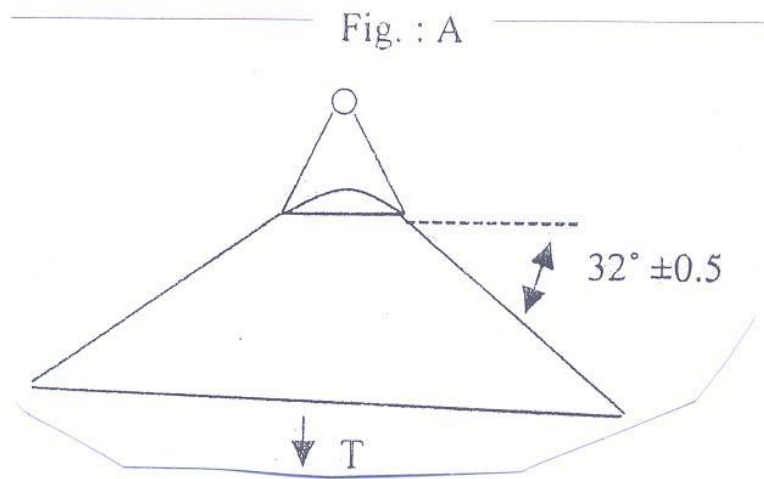

A sample messenger shall be fitted into a fixed suspension clamp and subjected to a gradually applied longitudinal load of 300 N. There shall be no permanent slippage.

7.5 Voltage Test of SA

A copper foil is wrapped at the clamping point around the maximum size of messenger allowed in that clamp. An ac voltage of 6 KV is applied between the copper foil and nearest conductive point of the clamp or into its absence to the point of fixation. The voltage should be withstood for 1 minute without breakdown or flashover.

7.5 Test Under Mechanical & Thermal Stress (as applicable)

The test specimen is made up of approx. 10mts. Of messenger wire strung between two anchor clamps with a Suspension Clamp fixed in the middle. Masses of 40 Kg. are suspended at a distance of 1-2mtr. On either side of the Suspension Clamp with a fixing mechanism of mass 2 + 1 Kg.

The specimen is subjected to 500 cycles of 90 minutes each. Each cycle consists of the following:

- a) For first 75 minutes a constant longitudinal tension of 4000 N is applied to the messenger for rating of 1500 Kg. and of 4500 N rating of 2000 Kg. while 64 cycles right and left oscillation are produced on the clamp 32O on either side of the vertical.
- b) During the first 45 minutes an intermittent current of 4-5 A/sq.mm is applied to maintain the conductor temp at 60 + 3 O C.
- c) During the next 45 minutes of the cycle the conductor is allowed to cool down naturally to the ambient.
- d) At the 75th minute, after having completed 64 oscillations, the oscillations are stopped and the longitudinal tension is increased to 7500 N for 1500 kg. Rating and 10000 N for 2000 Kg. Rating.

5.3.9.3 - No messenger slippage should occur within the Suspension Clamp during the 500 cycles.

5.3.9.4 - At the end of the 500 cycles, the messenger is immersed in water for 30 minutes. It is then tested to withstand 10 kV ac for 1 minute with a trip setting of 10 + 0.5 mA. There should be no breakdown or flashover.

8.0 Acceptance Tests

8.1 The following shall constitute Acceptance Tests for **Insulation Piercing Connectors (IPC)** : (* please refer table below)

- Visual *
- Dimensional (as per SCD and overall dimensions submitted with Tender Offer)*
- Electrical Ageing Test ***
- Dielectric and Water Tightness Test. **
- Mechanical Tightening Test for shear head behavior, electrical continuity and over-tightening **
- Effect of Tightening on Main Core **
- Effect of Tightening on Branch Core **

The above tests are to be carried out as per sampling plan below. However electrical ageing test on IPC (marked***) is to be done on only one connector of each type and size.

In case of random failure/defect, double the sample lot is to be drawn and there should be no failure/defect exceeding half the permissible defects (rounded down) shown in the chart.

Lot Size	For test marked *	Max permissible defects	For test Marked **	Max permissible defects
	Sample Size		Sample Size	
Upto 100	2	Nil	2	Nil
101 to 1000	6	Nil	4	Nil
>1001	0.01% subject to min. 6 pieces	0.1% of pieces checked	4	Nil

8.2 The following shall constitute acceptance tests for **Anchor Assemblies**:

- Visual *
- Dimensional (as per SCD and overall dimensions submitted with Tender Offer)*
- Mechanical Test on Bracket**
- Mechanical Test on Clamp **
- Voltage Test *

8.3 The following shall constitute acceptance tests for **Suspension Assemblies**:

- Visual *
- Dimensional (as per SCD and overall dimensions submitted with Tender Offer)*
- Mechanical Test on Bracket**
- Mechanical Test on Clamp **
- Voltage Test *

The above tests (for AA & SA) are to be carried out as per sampling plan below. In case of random failure/defect, double the sample lot is to be drawn and there should be no failure/defect exceeding half the permissible defects (rounded down) shown in the chart.

Lot Size	For test marked *	Max permissible defects	For test Marked **	Max permissible defects
	Sample Size		Sample Size	
Upto 100	2	nil	1	Nil
101 to 500	5	1	2	Nil
501 – 2500	10	2	2	Nil
501 – 2500	10+0.2%	2+10% pf addl sample quantity	4	1

9.0 Type Test:

For all accessories, the Type Test Report should be submitted from an Independent NABL Accredited Laboratory like CPRI or the ILAC MRA signatory Laboratory in case of a foreign manufacturer covering the following (on any convenient size of fitting of same design made from the same materials). The type test should not be older than 3 years as on the date of tender opening. The bidder shall submit the type test reports along with the bid.

The installation of the connectors shall be done in the laboratory following instructions provided by the manufacturer. The Test report shall record the embossing and marking on the connector.

The following shall constitute Type Tests:**9.1 For Insulated Piercing Connectors:**

- a) Electrical Ageing Test
- b) Dielectric and Water Tightness Test.
- c) Mechanical Tightening Test
- d) Effect of Tightening on main Core

- e) Effect of Tightening on Branch core

Over-current Test (if applicable for the size)

9.2 Type Test for Suspension Assembly (SA)

- a) Mechanical Test
- b) Voltage Test
- c) Climatic Aging Test
- d) Corrosion Test
- e) Endurance Test under Thermal & Mechanical Stresses (if applicable)

9.3 Type Tests for Anchoring Assemblies (AA)

- a) Mechanical Test
- b) Voltage Test
- c) Dynamic Test
- d) Climatic Aging Test
- e) Corrosion Test
- f) Endurance Test under Thermal & Mechanical Stresses

GA drawing and approximate dimensions shown in the Annexed drawings are for illustration purpose only. The bidder/manufacturer shall furnish his drawings confirming to the technical requirements of this specification.

10.0 SERVICE CLAMP

The clamps should be designed to anchor insulated service lines (armored or unarmored) with 2/4 conductors.

- The clamps should be made of weather and UV resistant polymer.
- The service clamp should accommodate cables from 6 mm sq to 35 sq mm in the same clamp.
- The gripping mechanism shall consist of two insulated self wedges that are un-loosable from the body and do not require any hand tools to grip the cable.
- The clamp should conform to the standard NFC 33042 or equivalent I.S., if any. No losable
- Breaking Load of the clamp should not be less than 3 KN.

11.0 STAINLESS STEEL STRAP ASSLY

The stainless-steel strap assembly shall consist of

- a) Stainless steel strap of size 20+_0.2mm x 0.7+_0.05mm and shall have tensile strength of 7.5KN min., elongation 30% Min, finish 2B, and the stainless steel material shall be of corrosion and wear resistant.
- b) The buckle to suit above strap shall be used.

12.0 TRANSFORMER CONNECTION

- The connection to the transformer should be made with Pre-Insulated lugs for phase and street lighting conductors and with an Aluminium Lug for neutral Messenger. If the Bus-bars-bars are of copper, the Lugs should be preferably Bi-metallic type.
- The Barrel of the lug normally insulated with an Anti-UV black Thermoplastic tube sealed with a flexible ring. Die reference, size and strip length are to be indicated on the plastic.
- Sizes covered 16-70 & upto 150 m² Aluminium XLPE insulated cable.
- Reference standard NFC 33021 or equivalent I.S. if any.

13.0 JUNCTION SLEEVES (Mid span joints)

- The sleeves should be pre-Insulated for phases, neutral messengers and street lighting conductors.
- Sleeve should be made of Aluminium, insulated with an Anti-UV black thermoplastic tube hermetically sealed two ends with 2 flexible rings.
- Die reference, size and strip length are indicated on the sleeve itself.
- Sizes needed: 16-70 & upto 150 mm² for Aluminium XLPE insulated cable.
- Reference standard: NFC 33021 or equivalent I.S. if any.
- Design as per furnished drawing or equivalent.

14.0 EYE HOOKS

- Eye looks should be designed as to hold suspension clamps and Dead end clamps and to be installed with the pole clamp.
- Eye-hooks should be made of forged Galvanized steel.
- The clamps corrosion resistance should conform the standards I.S. 2629 & I.S 2633.
- Bolts and nuts should be made of hot dip Galvanized steel according to VDE 0210 and VDE 0212.
- Ultimate Tensile strength (UTs) of the clamp should 20 KN.
- Design as per furnished drawing.

15.0 SERVICE MAIN DISTRIBUTION BOXES

15.1 Scope

This Distribution Box should be Weather & Moisture Proof with Spring loaded; Bolt & Nut type Bus Bar system & should be able to carry a current according to specified capacity. It can have 1/3-phase input & provision of 6 Nos. of 3-phase or 1-phase outputs. The box should have the provision for special key for locking & Proper arrangement of sealing. The boxes should be assembled on the pole using Metal Tapes & Buckles or Bolts. No. of Boxes per pole may vary with supporting arrangement for more no. of service connections. The Spring used

should be of stainless steel having required capacity to provide suitable pressure in the connector.

15.2 Construction details.

Distribution Boxes should be designed with Bus Bars with spring action contact. For spring action contact only insertion of the conductor into the specified groove of the Busbar is sufficient for proper connection. The springs should provide sufficient force to ensure good contact and are to be made of stainless steel only.

It should be used for multiple connections (3-phase or 1-phase) in low voltage Distribution Network. The boxes should be suitable for 1/3-phase (4 cores) inputs & provision for 6 nos. of 3-phase or 1-phase outputs. Bus bars should be with a continuous pair of contact bars with colour code to facilitate the identification of the correct energy phase. The minimum clearance between phases shall be 35mm.

The box should be able to incorporate the input or output cable suitable for incoming cable upto 50 sq mm aluminum and outgoing cables upto 35 sq mm aluminum.

The Boxes should consist of special type Lock & key system as well as provision for sealing for complete protection of the service connection contacts. The boxes should be supplied with mounting channel arrangements.

15.3 Current Ratings

The maximum current rating should be 140A/200A/250A & concerned authority should have the liberty to choose among the above ratings as per their requirement.

15.4 Voltage Ratings:

The maximum voltage withstand capacity should be 600V.

15.5 Working Temp

Safe working temperature should be around 90C for Outer Box & 100C for metallic Busbars.

15.6 Materials

The box/enclosure shall be made of Injection Moulded Glass Filled Fire Retardant engineering plastic or UV resistant Thermoplastic 2.0 mm minimum thickness, capable of withstanding boiling water for 10 minutes without deformation of plastic. The heat deflection temperature of the plastic should be 125°C @ 0.45mpa. The engineering plastic shall be UV protection & flame/fire retardant made up of Vo as per UL- 94. The colour of the box may be dark grey or as approved by the purchaser.

The Busbars shall be made of EC grade copper and with a total cross section of 75sq. mm approx. The minimum clearance between phases shall be 35 mm.

Molded casing of Bus Bar shall be made of Nylon glass filled capable of withstanding fire retardancy test (Glow wire test) at 950°C as per Specification No. IEC Publication 695–2–1

The box shall have built in type hinges, no screws/rivets visible from outside.

Suitable gasket shall be provided all around the cover to ensure sealing.

The box should have built in Earth Plate. The gland plate shall be of metallic with No of holes equal to the No of circuit provided.

Material used in the manufacturing process of the components of this product should be specified in the respective product drawings & can be summarized as follows

- Outer Box (Base & Cap) : With UV protection & Flame retardant characteristics (V_0 , as per UL 94-Tests for Flammability of Plastic materials type HB is not acceptable).
- Cable Grommets: Ethylene-Propylene Rubber:
- Safety Key: PA 6.6 (Nylon).
- Safety Screw: Stainless Steel or Plating Finished steel.
- Ingress protection as per IP 55.
- Bus bars or Terminal Blocks: PA 6.6 (Nylon), Stainless Steel & Copper.
- Button & Cable Holder: PA 6.6 (Nylon) with 50% Glass Fiber.
- Busbar Insulation : Polyamide.

15.7 Locking System

The boxes should consist of Special type Lock & Key arrangement as well as provision for sealing for complete protection of the service connection contacts.

15.8 TYPE TESTS /Routine/Acceptance Tests.

Type Test Reports have to be submitted for the following tests done on any one model of similar Distribution Box with total outgoing connections not less than those required in this tender from any NABL accredited laboratories only.

SI No	Standard	Clause	Requirement	Test Particulars		
				Type	Routine	Acceptance
1	IS:14772	7	Marking	T		A
2	AS per specs & GTP	-	Dimensions	T	-	A
3	IS:14772	9	Protection against electric shock	T	R	-
4	IS:14772	12	Resistance to aging to humid conditions, to ingress solid object & to harmful ingress of water IP:55	T	-	-
5	IS:14772	13	Test for mechanical strength	T	-	-
6	IS:14772	14	Resistance to heat	T		
7	IS:14772	16	Resistance to rusting	T		
8	IS:14772	17	Resistance to tracking	T		
9	IS:14772/ IEC 695-2-1		Glow wire test at 95°C	T		
10	IS:8623		Verification of dielectric properties	T		

11	IS:13411		Heat deflection test of 150°C at 0.45 MPa	T		
12	IS:4249	3.5.1	Test for self extinguishing properties	T		
13	IS:11731-II		Flammability test	T		
Following tests are to be conducted for bus bar						
14			Temperature rise at 200 Amp	T		
15	IS:2683-I		Verification of electric properties of molded casing of bus bar at 2.5KV	T		
16	IS:11000-I/ IEC 695-2-1		Glow wire test at 95°C of molded casing of bus bar	T		

15.9 G.A. DRAWINGS ETC.

- A drawing / picture clearly showing principal parts & dimensions for all products should be submitted prior to supply of item.
- The principal outer dimensions of each item, l x b x w in mm and weight in kgs should be submitted along with the offer.
- The Purchaser may call for samples for verification & evaluation purposes.

16.0 GENERAL CONDITIONS OF MANUFACTURE – Annexure – 2

17.0 GTP

The Guaranteed Technical Particulars should be filled up in the given format of GTP. - Annexure-3 to 5.

18.0. TESTING STANDARD – Given in Annexure 5 & 6.

ANNEXURE – 1**METEOROLOGICAL DETAILS****Sl. No. Parameters Unit Value**

1.	Maximum ambient air temperature	39°C
2.	Maximum temperature of air in shade	25 °C
3.	Maximum daily average temperature	38 °C
4.	Maximum yearly average temperature	30°C
5.	Maximum yearly weighted average temperature	28°C
6.	Minimum ambient air temperature	12°C
7.	Maximum relative Humidity	80%
8.	Average annual Rainfall	3175 mm
9.	No. of months of tropical monsoon -	(June-Oct.)
10.	Maximum wind pressure	100Kg/m ²
11.	Seismic Zone as per IS : 1893 – 1984 -	III & IV
12.	Maximum height above mean sea level	1000Mtrs.

Note:

- 1) Any specific meteorological data other than those listed above applicable for a particular equipment/item will be available in the technical specification for that equipment/item.
- 2) When values specified above contradicts with respective equipment TS, the later will prevail for that equipment.
- 3) The atmosphere in the area is laden with industrial and town gases and smoke with dust in suspension during the dry months and subject to tough colder months.
- 4). Heavy lightning is usual in the area during the months from May to November.

ANNEXURE-2

GENERAL CONDITIONS FOR MANUFACTURE

The products shall be in accordance recognized standards used in L.T. ABC or equivalent I.S., if any.

Marking : Each product shall be clearly identified with manufacturer name or trade mark, reference and capacity of the item and batch no.

Packaging : Manufacturer shall mention the packaging of each item. Installation Instruction should be included in packaging.

Type test : Each supplier should provide type test reports with the offer, carried out in accordance with one of the reference standards in NABL Accredited or equivalent Laboratory. The reports shall not be older than THREE years as on the date of tender opening.

Routine test : Supplier shall provide a quality control plan, which will be implemented on each item. The manufacturer should have complete Routine Test facilities in house. Routine test reports should be submitted by the manufacturer with inspection call. The buyer reserves the right to inspect the materials at manufacturer's premises before dispatches. The manufacturer shall provide all facilities for routine tests.

Quality : Only ISO-9000 certified manufacturer will be considered for supply.

- Anchoring and suspension clamps should be installable on existing poles using existing cross arms wherever feasible by means of hooks, brackets etc. Use of stainless-steel straps with buckles and aluminum bracket arrangement is also acceptable. If MS pole clamps are used they should be hot dip galvanized.
- All crimping should be done for jointing sleeves etc., with mechanical or hydraulic hand crimping tools.

ANNEXURE – 3

**GUARANTEED TECHNICAL PARTICULARS FOR ANCHOR (DEAD END) CLAMPS /
SUSPENSION CLAMPS SUITABLE FOR INSULATED SERVICE LINE CABLE.**

SI No	Parameters	Unit	Bidder's Offer
1	Type of Clamp		
2	Name of the Manufacturer		
3	Standard		
4	Place of Manufacturer		
5	Range of conductor size	Mm (Dia)	
6	Type of design		
7	Installation (with / without disassembly)		
8	Type & grade Metallic / Nonmetallic Material		
9	Marking		
10	Colour of Nonmetallic parts		
11	Dimensions	mm	
12	Approximate weight kg	kg	
13	Breaking Load kN	kN	
14	Test voltage (Min 6 KV AC for 1 minute)		
15	Maximum load holding capacity (Kg.)		
16	Max. vertical load sustained by clamp (Kg.)		
17	Max. longitudinal load sustained by clamp		
18	Is type test report enclosed		

ANNEXURE – 4

GUARANTEED TECHNICAL PARTICULARS FOR INSULATING PIERCING CONNECTORS (IPC)

SI No	Parameters	For Street Light	For Charging DB	For ABC to ABC TEE
1	Name of the Manufacturer			
2	Is Manufacturer of accessories as ISO 9001-2000 company a) Copies of certificate enclosed b) Are GA Drawing enclosed			
3	Applicable standard			
4	Type of connectors Main :	5. 16-95sqmm Tap : 1.5-10 sqmm	Main: 16-95sqmm Tap : 4-35 sqmm	Main: 25-95sqmm Tap : 25-95 sqmm
5	Application	For 1.1 KV	For 1.1 KV	For 1.1 KV
6	Is any metallic part carrying potential in operation exposed during installation			
7	Are end caps of branch cable a) Slide on type b) Rigid			
8	Are torque limiting shear heads provided to tightening bolts			
9	Range of cable sizes accommodated for main & branch	Main : 16-95 sqmm Tap : 1.5-10 sq.mm	Main: 16-95sqmm Tap: 4-35sqmm	Main: 25-95sqmm Tap: 25-95sqmm
10	Min. & Max. torque defined			
11	Torque for establishing connection between main and branch			

SI No	Parameters	For Street Light	For Charging DB	For ABC to ABC TEE
12				
13	Max. tensile load for no breakdown of main conductor (for each cross section)			
14	Max. tensile load on branch conductor for no break/slippage			

15	Voltage withstand under water emersion			
16	Is electrical Ageing test report enclosed			
17	No. of Cycles			
18	Max. temp. at each cycle			
19	Marking and embossing on the connection			
20	Is type test report enclosed?			

ANNEXURE -5**GUARANTEED PARTICULARS FOR DISTRIBUTION BOX**

SI No	Particulars	Unit	Bidder's Offer
1	Name of the manufacturer		
2	Offered type of DB		
3	Material of DB enclosure		
4	Is spring loaded system offered		
5	Thickness 2mm min.		
6	Ingress protection class offered		
7	Suitable for cable of size (max) Incoming- Out going-	mm mm	
8	Material of bus bar		
9	Cross sectional area of bus bar		
10	Insulation level		
11	Is built in Earth Plate provided		
12	Is type test reports enclosed		

ANNEXURE – 6**TESTING STANDARDS:**

The Insulating Piercing Connector should conform to following std.:

Tests	Tests Standard / Test Procedure
Corrosion Qualification Test	As per NF C 33-020 (Jun '98), or equivalent I.S., if any. Exposure in Saline Environment: The exposure should be carried out as per NF en 60068-2-11 (Aug. '99) std. requirement. The concentration of Saline solution must be of 5% + 1% in mass, & the temperature of the test chamber must be maintained at 35°C + 2°C. Exposure in Sulphur environment saturated of humidity – The exposure should be carried out as per NF T 30-055 (Mar. '74) std. requirement. SO ₂ concentration in the chamber should be 0.067% in volume. The temperature of the test chamber should be increased to 40°C + 3°C. The total test should include four identical periods of 14 days, in which 7 days of exposure in Saline environment & in other 7 days –8 hrs. Cycles in SO ₂ environment & 16 hrs, in laboratory environment.
Electrical Ageing Test	As per NF C 33-020 & NF C 33-004 (Jun '98) or equivalent I.S., if any. Total no. of cycles 200, Heating time -60 mins, Cooling time -45 mins, Pause time – 2 mins.
Dielectric Investigation Test in	As per NF C 33-020 (Jun '98) or equivalent I.S., if any. The connector should be placed in an ambient temperature between Water 15°C & 30°C & relative humidity between 25% & 75%. The tightening of the connectors should be at minimal value of the torque indicated by the manufacturer. The sample should be placed in tank full of water on 30 cm height, after an immersion length of 30 mins. The set is subjected to a dielectric test under a voltage of 6KV at industrial frequency during 1 min. No flashover / breakdown should occur at 6 KV during 1 min.
Mechanical Tests	As per NF C 33-020 (Jun '98) or equivalent I.S., if any. For checking electrical continuity, shear heads & mechanical behaviour of the connector's suitable tests as per the above Specifications have to conduct.

Capacity needed:

For ABC 16 to 95 mm²

Model 1 for customer service:

Main 16 to 95 mm²

Tap 2.5 to 10 mm² (For Street lighting)

Design as per furnished drawing

Model 2 for customer service:

Main 16 to 95 mm²

Tap 04 to 35 mm² (for distribution box charging)

Design as per furnished drawing

Model 3 for customer service:

Main 25 to 95 mm²

Tap 25 to 95 mm² (For ABC to ABC Tee Joint)

Design:

As per Standards & typical drawing
furnished.

ANNEXURE – 7

TESTING STANDARDS

Impact Resistance should be according to UL 746C. Ingress Protection should be as per IP 55. The Outer Plastic box should conform to following std. –

Test / Standard	Requirements	Test Procedures
Degree of Protection IEC 60529	IP 55 – Protected against the penetration of solid objects exceeding 1.0mm in diameter and against penetration of water jets that may affect the product operation.	First Digit: A 1.0mm diameter test wire should not penetrate in any apparent opening (force = 1 N + 10%) Second Digit: A spray nozzle is used to spread a water jet in all possible directions.
Impact Resistance UL 746-C	After the test the product should not show any evidence of: - Live electrical parts accessible to the test probe, as described in this test specification. - Any results, which may affect the mechanical performance of the product. - Any results, which may increase the probability of electrical shocks.	The impact should be generated by dropping a steel ball – with a diameter of 50.8 mm and a mass of 0.535 kg – from a specified height sufficient to produce an impact energy of 6.8 J (0.69 13 kg.m.)
UV Resistance UL 746-C	The sample physical properties average value after an accelerated aging with UV radiation – should not be lower than 70% of its initial value, without aging, that is, a variation of + 30% is allowed.	According to ASTM G26, Exposure Method 1, Xenon Arc Lamp Type B or ASTM G 155, Exposure Cycle I, with continuous exposure to light and intermittent exposure to water jets, with programmed cycles of 120minutes, consisting of a 102minutes light-only exposure and a 18 minutes exposure to light and water jets.
Withstanding Voltage UL 746-C	Product should withstand the specified voltage	A 5 kV voltage should be applied to the samples after the 40 hours conditioning cycle at 23 + 2°C and 50 + 5% relative humidity plus 96 hours at 35 + 2OC and 90+5% relative humidity.
Flammability UL 94	After the UV radiation accelerated aging, the material should maintain the same original flammability level (HB).	The test can be applied to test samples molded with the same material used for the base and the cap of the box or taking a piece of these components.
Flexural Strength ASTM D790 UL 746-C	After UV radiation accelerated aging, the average value for this test should not be lower	A group of test samples without aging should be tested and the average values calculated. Another group should be

	than 70% of the original value, that is, a maximum variation of 30% is allowed.	aged under UV radiation then it should be tested and the new average should be calculated and compared to the initial average value.
Tensile Strength ASTM D638 UL 746-C	After aging with UV Radiation, the average value should not be lower than 70% of the initial values, that is, a maximum variation of 30% is allowed.	One of the test bodies must be tested without being submitted to accelerated aging and is computed over mean values. Another group is submitted to the radiation induced aging and then tested and the new mean value is computed and compared to the first computed mean value.

SECTION – 8

**L.T. PVC INSULATED SINGLE CORE ALUMINIUM
LEAD WIRE (MULTI STRAND)**

Technical Specification for L.T. PVC Insulated Single Core Aluminum Lead Wire (Multi Strand).

1.The PVC Aluminum lead wire (multi strand) shall be of 1,100 volts grade and shall be single core. The cable shall be supplied in coils of 100 Mtrs. Length.

2.The lead wire (multi strand) shall be manufactured, tested and supplied as per IS-694 of 2010 with latest amendments if any.

3.The conductors shall be composed of Aluminum wires complying with IS-8130 of 1984 with latest amendments, if any. The conductor particulars shall be as noted below.

Note: The conductor shall satisfy the requirement of resistance as per IS-8130 and also the nominal cross section specified below:

Sl. no	Cable	Conductor	Weight of Aluminum in kgs/100m	Remarks
1.	50Sq. mm	19/1.83mm	14.40	Un Sheathed
2	70 Sq.mm	19/2.17mm	20.17	Un Sheathed
3	95 Sq mm	19/2.52mm	27.40	Un Sheathed
4	120 Sq mm	37/2.03mm	34.58	Un Sheathed
5	150 Sq mm	37/2.27mm	43.22	Un Sheathed
6	185.0 Sq .mm	37/2.52 mm	53.30	Un Sheathed
7	240.0 Sq .mm	37/2.85 mm	70.30	Un Sheathed

(The weights of Aluminum conductor given above are as per IEEMA circular)

4. The conductor shall be provided with PVC insulation applied by extrusion and the PVC compound shall be type 'A' of IS5831 of 1984 with latest amendments, if any and shall satisfy test requirements for PVC insulation stipulated in IS 5831.

5. The color of the cable and sheath shall be Black.

6. Packing & Marking:

6.1 The Marking shall be as per IS: 694 of 2010 with the following details;

A On the Lead Wire:

- i) Reference of Indian Standard IS 694;
- ii) Manufacturer's name, Brand name or Trade-Mark;
- iii) The letter "BESCOM".
- iv) Year of manufacture
- v) Type of cable and Voltage Grade;
- vi) Nominal cross-sectional area of conductor;
- vii) Cable code;
- viii) Color of core;
- ix) The word 'suitable for outdoor use' ;

The printing, indentation or embossing shall be done on the insulation. The distance between any two consecutive printings, indentations or embossing shall be not more than 1m.

B On the Drum/ Reel:

- i) Length of the cable on the reel, drum or coil;
- ii) Direction of rotation of drum (by means of arrow);
- iii) Approximate Gross Weight in kgs;
- iv) Year of manufacture;
- v) Purchase Order reference and Date.

6.2 The packing of the cable reel or drum shall also be marked with the standard markings and BESCO Purchase order reference.

7. Test Certificates: -

- a) All the type test certificates on conductors, PVC insulation etc. stipulated in IS 694 of 2010 with latest Amendments, if any shall be submitted for approval.
- b) In case of an order, all the acceptance tests stipulated in IS 694 shall be conducted in presence of BESCO/ KRIDE representative.
- c) Routine tests shall be conducted and test reports in the form of test certificates signed by a responsible officer of the firm shall be submitted to this office for approval before dispatch of the material.

GUARANTEED TECHNICAL PARTICULARS		
Name of the bidder		
Sl. No	Particulars	Particulars to be furnished by the bidder
	 Sq.mm lead wire
1	Size of Cable	
2	Nominal area of cross section in Square mm	
3	Number of strands and dia of each strand	
4	Voltage class	
5	Radial thickness of insulation in mm	

6	Nominal overall diameter of cable in mm	
7	Name of manufacture (Brand Name)	
8	Colour of Cable	
9	Maximum resistance of the conductor per KM at 20 Deg C.	
10	Length of cable per coil	
11	Estimated conditional rating in amps corresponding to the temperature of 80 Deg C.	
12	Weight of Aluminium/ coil of 100 Mtrs.	
13	Total weight of the Cable / Coil of 100 mtrs.	
14	Purity of Aluminium rods.	

SECTION – 9

**HEAT SHRINKABLE TYPE,
TAPE X TYPE, PRE MOULDED TYPE AND COLD
SHRINKABLE TYPE JOINTING KITS AND
TERMINATIONS**

**TECHNICAL SPECIFICATION FOR HEAT SHRINKABLE TYPE,
TAPE X TYPE, PRE MOULDED TYPE AND COLD SHRINKABLE TYPE JOINTING KITS AND
TERMINATIONS**

- 1.0 This specification covers the design, manufacture, testing and supply and Heat Shrinkable type, Premoulded type, Cold shrinkable type, Tapex type, Jointing and termination kits suitable for XLPE and PILC Cables manufactured in general conformity to the standards published by Bureau of Indian Standards, New Delhi.
- 1.1 The purchaser reserves the right to place orders for any type of terminations/joints.
- 2.0 The tenderers shall furnish the type and complete technical details of joints/terminations offered with dimensional drawings, materials, literature, type test certifications from recognized test houses/institutions prior to supply of item.
- 3.0 The cable jointing kits/terminations are required for use on PILC/XLPE Cables, the details of which are as noted below:
1. Type : PILC/XLPE insulated conductor and insulation screened.
 2. Voltage : 11KV
 3. Conductor : Circular Compacted Aluminium
 4. No. of Cores & Cross Sectional area of conductor : Three Core – 95, 240 and 400 Sq.mm.
Single Core – 1000 Sq.mm.
 5. Armour : G.I. Round/Formed, Wire/Hard drawn, Aluminium wire.
 6. Sheath : a) Lead alloy E. Sheathed in Case of PILC Cable.
b) PVC Compound type ST-2 in case of XLPE Cable.
 7. Installations : Directly buried in ground. .

4.0 **HEAT SHRINKABLE TYPE:**

- 4.1 The term 'Heat Shrinkable' refers to extruded or moulded – polymeric material which are cross linked to develop elastic memory and supplied in an expanded or otherwise deformed size and shape. Subsequent heating in an unconstrained state to a temperature above the shrink temperature results in the materials recovering or shrinking to its original shape.
- 4.2 Stress control and stress grading wherever necessary in the termination and joint shall be by means of semi conducting heat shrinkable tubing.
- 4.3 Environmental sealing between the heat shrinkable materials and cable surfaces shall be achieved by using hot melted sealants or adhesives. Where such sealants or adhesives are

exposed to high electrical stress, they must be track resistant. The adhesive or sealant used in the joint/terminations should not permit any entry of moisture into the joint/termination.

4.4 The external covering of insulated cores for terminations shall be by means of modified silicon heat shrinkable tubing's, which have non tracking and erosion resistant properties. The purchaser reserves the right to insist on checking the tracking resistance property of the non tracking materials.

5.0 **PREMOULDED TYPE (XLPE CABLE):**

5.1 The term premoulded refers to of pre manufactured work-tested parts of a termination or joint of moulded Ethylene Propylene Diene Monomer (i.e. EPDM) rubber or silicone Rubber components with non tracking and erosion resistant properties.

5.2 The stress control and stress grading components/material wherever necessary in the terminations and joints shall be highly track resistant insulating section vulcanized to a semi conducting section.

5.3 Interface between the premoulded stress control/grading – component screen material and cable surface shall be achieved by semi conducting material which has cold flow properties. The design should eliminate voids/air packets at the interface and discharge at the cable screen edges.

5.4 The stress cone must be of proven design for stress control. The semi conducting portion of the stress cone should be vulcanized with insulation so that both semi conducting and insulation portion becomes an integrated part.

5.5 Environment sealing and to prevent ingress of moisture – between premoulded components and cable surface/end shall be provided with compatible component/device.

6.0 **TRANSITION JOINTS:**

In this specification the transition joint is defined as a straight through cable joint between two cables of different designs. The construction of the two cables to be joined, differ in insulation material, water barriers and configuration of cores, and stress distribution.

The transition joint is intended to be used between two cable 11 KV Grade, 3 core of following description.

1. Paper insulated, Mind, Lead Covered, Double steel tape/round wire armoured of either belted or screened design. The conductor is Aluminium with stranded sector shape or stranded circular shape.
2. Cross linked polyethylene insulated cables of screened type with formed wire or round wire Armour, with PVC jacket. The conductor is Aluminium circular, compacted, generally the sizes of the conductor are 95, 240 and 400 Sq.mm.

7.1 **Design Requirements:**

The joint must be capable of meeting the performance requirements of both the PILC and XLPE cables. The design must ensure that any interaction between the jointing – materials and the cable materials are not detrimental to either the performance of the transition joint or the cables to be joined.

i) **STRESS CONTROL**

The design of transition joint must control and limit high electrical stress and prevent discharges which occur at.

- a) The termination (cut) of the lead sheath or earth envelop in a three core belated cable.
 - b) At the screen cut back in a screened cable.
 - c) In the area of conductor connection (Ferrule/connector).
- ii) **CONTENT OF PAPER IMPREGNANT**
The design should ensure that there will be no contact between impregnant of the paper cable and the insulating and screening materials on the XLPE side of the joint. The transition joint must be capable of totally eliminating any migration of the impregnant form the MI/MIND cable to XLPE cable.
- iii) The transition joint must provide for continuation of armour/ earth continuity. The fault current carrying capacity of the earth/armour continuity must not be less than that provided on the cables being joined.
- iv) The transition joint must be provided with a strong over-all cover for a protection to prevent ingress of moisture in to the joint.

8.0 **TAPEX TYPE SYSTEM:**

8.1 The term Tapex refers to the kits using self amalgamation/self vulcanizing insulation tape made of EPDM Rubber/EPR Tapes and Non linear stress grading material for stress control.

8.2 The stress control shall be by means of non liner resistance material.

8.3 The joints and terminations shall met the requirement of class 1 accuracy of IEEE-48.

8.4 The stress grading material shall be wrapped around the cable core, overlapping the edge of the outer conducting layer. The top layers shall fuse together to form a compact rubber body around the stress grading material and cable core thereby exert on active pressure on cable.

8.5 **DESIGN REQUIREMENTS:**

The joints and terminations shall provide the following performance function:

- a) Electric Stress Control between the semi conducting screens and over the ferrule.
- b) Reinstatement of cable insulation.
- c) Environmental and moisture sealing.
- d) Mechanical strength and protection.
- e) The tapes shall be self amalgamating/self vulcanizing having Antitracking, Corona, Ozone and UV light resistant.
- f) The joints and terminations shall not require penciling of insulation and preparation of semi conducting screen at right angles or evenly.

9.0 **REQUIREMENTS:**

The Heat Shrinkable Type/Premoulded Type/Tapex Type/Straight Through Joints, Transition Joints, Indoor and Outdoor Terminations shall be suitable for 11KV, XLPE and PILC Underground Cable of sizes.

- a) 3 Core x 95 Sq.mm.
- b) 3 Core x 240 Sq.mm.
- c) 3 Core x 400 Sq.mm.
- d) 1 Core x 1000 Sq.mm.

9.1 The approximate total requirement of jointing kits and terminations of various sizes are as per Annexure.

9.2 The quantity shown is only approximate and is subject to increase or decrease depending on the actual requirement.

10.0 **SERVICE CONDITIONS:**

10.1 The straight through joint transition joints shall be suitable for use with cables which are directly buried in ground.

10.2 The indoor terminations shall be suitable for use in switchgear designed for both Indoor and Outdoor installation.

10.3 The outdoor terminations shall be suitable for use in directly exposed atmospheric conditions.

11.0 **POWER SYSTEM PARTICULARS:**

- | | | |
|--------------------------|---|--|
| 1. System voltage | : | 11 KV |
| 2. Highest voltage | : | 12 KV |
| 3. Neutral | : | Effectively earthed |
| 4. Frequency | : | 50 HZ + OR – 3% |
| 5. CSA of conductor | : | 3 core 95 to 400 Sq.mm.
Aluminium 1 core 1000 Sq.mm.
Aluminium |
| 6. Rated Current at 90°C | : | 3 Core 195 to 410 Amps
1 Core 740 Amps. |

12.0 **CLIMATIC CONDITIONS:**

- | | | |
|----------------------|---|--------------------------------------|
| a. Site locations | : | Various sites in Karnataka State. |
| b. Altitude | : | Not exceeding 1000M above sea level. |
| c. Ambient Temp. | : | 50°C Max. 5°C Min. |
| d. Relative Humidity | : | 100% Max. 10% Min. |
| e. Rainfall | : | As per Indian Monsoon. |

13.0 **STANDARDS:**

13.1 The testing of the completed system of joints and terminations shall be in accordance with the following standards, with latest amendments.

- a) IS 13573: Joints and terminations of polymeric cables for working voltages from 6.6 KV upto & including 33 KV performance requirements and type tests.

b) VDE 0278 Power Cables accessories with rated voltage up to 30KV.

The other applicable standards for testing of accessories and material properties of document shall be:

- i) IS 7098 Part (2) – 1985: Cross linked polyethylene insulated PVC sheathed cables.
- ii) IEC 60502 – Extruded solid dielectric power cables for rated voltages from 1 KV up to 30 KV.
- iii) ISI 0913 – Electricity supply industry (Electricity Technical Association) performance specification for high voltage heat shrinkable components for use with high voltage solid type cables Up to and including 33KV.
- iv) IEEE 48 – Test procedures and requirements for high voltage alternating current cable terminations.
- v) ISO-R 37 – determination of tensile stress strain properties of vulcanized rubbers.
- vi) ASTM – D – 2303 liquid contaminant inclined plane tracking and erosion test.
- vii) IEC 60243 recommended method of test for electric strength of solid insulating materials at power frequencies.

14.0 **DESIGN REQUIREMENTS:**

a) **Joints:** The joint shall provide for the following performance functions.

- i) Electric stress control between the cable semi-conducting screens and over the ferrule.
- ii) Reinstatement of cable insulation.
- iii) Environmental protection and moisture sealing.
- iv) Mechanical strength and protection.

b) **Terminations:** The terminations shall be designed to provide.

- i) Electric stress control for the cable insulation shield terminus.
- ii) Complete external leakage insulation between the cable conductor/conductors and earth.
- iii) Seal to the end of the cable against the entrance of external environment.

c) The joints and terminations in the form of completed system shall meet the type test requirements as per the standards:

- i) IS 13573
 - ii) VDE 0278
- } with latest amendments

15.0 **TESTS:**

15.1 **Routine Tests:**

- a) Visual inspection.
- b) Dimensional check.

c) Physical verification of kit contents as per bill of material.

15.2 **Acceptance Tests:**

- a) Tensile strength for tubings.
- b) Ultimate elongation test for tubings.
- c) Longitudinal shrinkage.

The above tests shall be conducted on samples selected at random from each lot of supply, at suppliers works or a reputed test house at suppliers costs.

15.3 **Type Test:**

The successful bidder shall arrange at his own cost for conducting of type test on a completed system, at a reputed test house. The samples for such tests will be selected at random by the purchaser out of supplies offered. The tests will be witnessed by the representative of the purchaser. The type tests to be conducted shall be as prescribed in IS 13573 – or equivalent standards.

16.0 **TEST CERTIFICATE:**

16.1 The material offered shall be fully type tested as per relevant standards and the tenderer shall furnish type test reports from CPRI, Bangalore or VDE test certificates from any National/International test house.

16.2 For any change in the design/type already type tested and the design/ type offered against this specification, the purchaser will draw a sample from the supplies and the type test on these will be carried out by the supplier at his cost. In case the material/system fails in the type test the entire lot will be rejected.

16.3 The purchaser reserves the right to demand repetition of some or all the type tests in the presence of purchaser's representative.

17.0 **DRAWINGS:**

The tenderer shall furnish the dimensional drawing of the joints and terminations offered.

18.0 **GUARANTEED TECHNICAL PARTICULARS:**

The guaranteed technical particulars of the joints/terminations offered shall be furnished by the tenderer prior to supply of item.

19.0 **TESTING FACILITY:**

The bidder shall furnish the details of manufacturing and testing facilities available with him and the address of their test houses where manufacturing and testing will be carried out.

20.0 **INSPECT AND TESTING:**

20.1 In respect of components like tubings, mouldings and sealants the bidder shall furnish the proof of source of supply, manufacture test reports and quality assurance reports along with the bid, against past supplies similar documents shall be made available in respect of this order during inspection and testing.

20.2 The supplier shall tender necessary assistance in inspection and for witnessing of testing at his work/test house.

21.0 **QUALITY ASSURANCE:**

The bidder shall invariably furnish the following information along with the offer. The information shall be separately given for individual components of the system offered, failing which the offer will be rejected.

- i) Statement giving list of important components, auxiliaries, source of supply of raw materials, list of standards according to which the materials are tested, list of tests carried out on materials, test reports under type approval and quality assurance.
- ii) List of areas in manufacturing process where stage inspections are normally carried out from quality control and details of such tests and inspections.
- iii) The quality assurance plan with hold points for owners inspection. The quality assurance plan and owners hold points shall be discussed between the owner and contractor before the QAP is finalized
- iv) The supplier shall furnish the routine test certificates of bought out accessories and central excise gate pass for imported items during inspection.

22.0 **DEVIATION:**

Any deviation from the specifications shall be set out clause by clause by the tenderer in a separate sheet titled "Technical Deviations".

23.0 **BILL OF MATERIALS/KIT CONTENTS:**

23.1 Each jointing/termination kit supplied as a single kit shall be self sufficient and contain all necessary electrical/mechanical components for making a complete joint/termination. There shall be absolutely no necessity of any additional material/component, except the contents supplied in the kit for making the joint/termination. Terminal lugs shall be of copper only.

23.2 The bid shall accompany with detailed list of kit contents/bill of materials, describing the component, quantity, material of component, dimensions size, weights lengths of tubings etc.

23.3 All the kit contents shall have unlimited life for storage in Indian conditions.

23.4 Any components which has a specific shelf life, the component should be stamped with date of manufacturing and the expiry date.

24.0 **PACKING AND MARKING:**

24.1 All components pertaining to a joint or termination shall be packed in a strong separate cardboard carton with each component sealed and labeled.

24.2 The package shall be marked with the name of the manufacturer, supplier, type designation, and relevant technical information along with address of consignee the details of consignment batch No., bill of materials for each package.

25.0 LIST OF DOCUMENTS TO BE FURNISHED WITH THE BID:

- 25.1 (i) Technical Brochure
- (ii) Drawings
- (iii) Installation Instructions
- (iv) Type test reports on complete (joint and termination) system and the components
- (v) Quality assurance plan
- (vi) Supply record, clearly indicating the address of the purchaser, order reference, material supplied, voltage class, quantity and date of supply.
- (vii) Test report literature, brochure of bought out items.
- (viii) Performance reports/certifications from customers.

26.0 GUARANTEE:

- 26.1 The jointing kits and terminations shall be guaranteed for satisfactory and trouble free operation for a period of five years from the date of supply against defects in the materials or design.
- 26.2 In case of failure within the guaranteed period due to faulty design and defective materials, and on such information to the supplier the jointing/termination kit will be replaced free of cost by the supplier within a period of 3 months from the date of intimation by the purchaser.

Heat Shrink Straight Through joint on 6.6kV (UE)/11kV(E) XLPE

Type: SHR

Sr. No.	Particulars	Unit	Guaranteed Values
1	MANUFACTURER		
2	APPLICABLE STANDARDS		
3	GAURANTEED PARTICULARS		
3.1	For the nominal (phase to phase)		
	System Voltages	KV	
	Maximum system coltage	KV	
3.2	A.C. withstand voltage Dry (ph/ground)	KV	
	time duration	Mins	
3.3	Partial Discharge at 1.73 U _o	pC	
3.4	Impluse Withstand, 1.2/50/Us	kV	
3.5	Load Cycle Test		
	a) Each Cycle-Heating Duration	Hrs	
	Temperature	o C	
	Cooling Duration	Hrs	
	b) Number of Cycles		
	c) Continuous phase to ground		
	Voltage withstand	kV	
3.6	Thermal Withstand Short circuit current 1Sec	ka	
3.7	Dynamic short circuit withstand	ka Peak	
4	KIT PARTICULARS		

4.1	Material of the tubing/moulded parts		
4.2	Method of stress control		
4.3	Method of environmental seal		
4.4	Allowable Kit storage Temperature	o C	
4.5	Shelf life of H.S. components	Years	
5	Cable Termination Instruction Manuals	Yes/No	

Heat Shrink Outdoor Termination on 6.6kV (UE)/11kV(E) XLPE cable

Type: OHR

Sr. No.	Particulars	Unit	Guaranteed Values
1	MANUFACTURER		
2	APPLICABLE STANDARDS		
3	GAURANTEED PARTICULARS		
3.1	For the nominal (phase to phase)		
	System Voltages	KV	
	Maximum system coltage	KV	
3.2	A.C. withstand voltage Dry (ph/ground)	KV	
	Time duration	Mins	
	A.C. withstand voltage Wet (ph/ground)	KV	
	Time duration	Mins	
3.3	Partial Discharge at 1.73 U _o	pC	
3.4	Impluse Withstand, 1.2/50/Us	kV	
3.5	Load Cycle Test		
	a) Each Cycle-Heating Duration	Hrs	
	Temperature	o C	
	Cooling Duration	Hrs	
	b) Number of Cycles		
	c) Continuous phase to ground		
	Voltage withstand	kV	
3.6	Thermal Withstand Short circuit current 1Sec	ka	
3.7	Dynamic short circuit withstand	ka Peak	
4	KIT PARTICULARS		
4.1	Material of the tubing/moulded parts		
4.2	Method of stress control		
4.3	Method of environmental seal		
4.4	Allowable Kit storage Temperature	o C	
4.5	Shelf life of H.S. components	Years	
5	Cable Termination Instruction Manuals	Yes/No	

Heat Shrinkable Indoor Termination on 6.6kV (UE)/11kV(E) XLPE cable**Type: IHR**

Sr. No.	Particulars	Unit	Guaranteed Values
1	MANUFACTURER		
2	APPLICABLE STANDARDS		
3	GAURANTEED PARTICULARS		
3.1	For the nominal (phase to phase)		
	System Voltages	KV	
	Maximum system coltage	KV	
3.2	A.C. withstand voltage Dry (ph/ground)	KV	
	Time duration	Mins	
3.3	Partial Discharge at 1.73 U _o	pC	
3.4	Impluse Withstand, 1.2/50/Us	kV	
3.5	Load Cycle Test		
	a) Each Cycle-Heating Duration	Hrs	
	Temperature	o C	
	Cooling Duration	Hrs	
	b) Number of Cycles		
	c) Continuous phase to ground		
	Voltage withstand	kV	
3.6	Thermal Withstand Short circuit current 1Sec	ka	
3.7	Dynamic short circuit withstand	ka Peak	
4	KIT PARTICULARS		
4..1	Material of the tubing/moulded parts		
4.2	Method of stress control		
4.3	Method of environmental seal		
4.4	Allowable Kit storage Temperature	o C	
4.5	Shelf life of H.S. components	Years	
5	Cable Termination Instruction Manuals	Yes/No	

**GUARANTEED TECHNICAL PARTICULARS FOR STRAIGHT THROUGH JOINTING
TRANSITION JOINTING & TERMINATION KITS SUITABLE FOR 11KV (E) SYSTEM**

SI.No.	Particulars	As per BESCOM
1	Name of manufacturer	Shall be specified by Bidder IS -13573, IS-13705 etc. 11LV 35KV 28KV 48KV Pd magnitude shall not exceed 20Pc for elastomeric & XLPE cables and 40Pc for PVC cables 75KV 5Hrs 3Hrs 60 7KV 7KV 2.55 x Isc
2	Applicable standards	
3	Rated Voltage of Cable accessories	
4	AC voltage withstand (Dry)	
5	AC voltage withstand (Wet) for out door termination)	
6	DC voltage withstand	
7	Partial Discharge test	
8	Impulse voltage withstand test	
9	Load cycle test	
	a. Each cycle Heating duration	
	Temperature	
	Cooling duration	
	b. Number of cycles	
	c. Continious Phase to earth voltage withstand	
10	Humidity test	
11	Salt Fog test(only for outdoor terminations)	
12	Thermal withstand short circuit test	
13	Dynamic short circuit withstand test	
14	tubing material	
15	method of stress control	
	method of environmental seal	
16	Non tubing Material	
17	Di electric insulating Material	
18	conductor resistance test	
19	Impact test	
20	Water tightness test	

21	Dielectric power factor test (Applicable for screened cables)		
22	Allowable kit storage temperature		
23	Shelf life of H.S components		
24	Cable termination Instruction manuals		

SECTION – 10

L.T. FEEDER PILLAR BOXES

TECHNICAL SPECIFICATION FOR LT FEEDER PILLAR BOXES

1.0 SCOPE:

1.1 This Technical Specification covers design, manufacture, assembly, inspection, testing and supply of

- a) 08-way LT Feeder Pillar Box.
- b) 12-way LT Feeder Pillar Box.

Complete with accessories and other miscellaneous equipment's specified in this specification.

2.0 STANDARDS:

2.1 The equipment should conform in all respects to the relevant latest editions of the Bureau of Indian Standards or other equivalent National or International Standards.

2.2 If the specifications other than those mentioned below are applicable, the fact should be made clear in the bid and one copy of such standard specifications in the English language shall be furnished.

2.3 The equipment shall also comply with the latest revision of the Indian Electricity Rules and any other applicable statutory provision, rules and regulations applicable in the location where these are to be installed.

2.4 The applicable standards are listed here below:

IS: 5-1994: Colour of ready mixed paints and enamels.

IS: 6875/1973 : Control switches, push buttons and related Part I & II control switches.

IS: 13607/1992 : Ready mixed paint, Finishing, General purpose, Synthetic.

IS: 13947/1993 : Specification for Low-voltage Switchgear and Control gear.

3.0 CLIMATIC CONDITION:

3.1 The Feeder Pillar Boxes offered shall be suitable for being used in the following weather conditions.

- a) Minimum temperature of air in shade - 5⁰ C
- b) Maximum temperature of air in shade - 50⁰ C
- c) Relative Humidity - 85% - 100%
- d) Average No. of rainy days per annum - 60 days
- e) Rain falls - 750-3000mm
- f) Altitude above means sea level maximum - 1000 Mtrs.

4.0 PRINCIPAL PARAMETERS:

The Feeder Pillar Box shall conform to the specific technical requirement specified here under.

- 1. Rated Voltage - 400 V \pm 10%
- 2. Rated Frequency - 50 HZ
- 3. Continuous Current Rating - 400A & 600A
- 4. Type - Out door
- 5. Mounting - On concrete foundation.
- 6. Suitable for - 3 ph 4 wire with Neutral Earthing
- 7. Maximum system Voltage - 1.1KV

8. Rated short Circuit Level - 50KA @ 400V.

4.1 FEEDER PILLAR BOX DESCRIPTION:

- 4.1.01 Feeder Pillar Box shall be suitable for the purpose for which they are intended to be used.
- 4.1.02 Each box shall be complete with accessories such as load break switches, bus bars, fuses, lock & key etc.
- 4.1.03 Feeder Pillar Box shall have access for sufficient ventilation and head description.
- 4.1.04 The cable entry and exit shall be from the sides through the extended box at the top on the sides. The design of the box must be such as to facilitate easy removal of the cable during erection and repair by suitable bolting the box cover and sliding the bottom plates. The entry of the cable at the extended box shall be through 100 mm PVC pipe and projecting 50 mm inside the box through suitable glands. The extended box shall be provided with suitable gland and clamps for fixing the cable rigidly. The feeder pillar box shall be suitable for 1.1kV 240 Sq.mm armoured UG cable through 100 mm PVC pipe and clearance inside the box must be such as to offer fair working facilities during erection and maintenance.
- 4.1.05 The box shall be vermin proof and dust proof.
- 4.1.06 Louvers of suitable size shall be provided in the front for ventilation and wire nets shall be provided on the back of the louvers to prevent the entry of dust and insect.
- 4.1.07 The box shall have double door (self-closing type) fitted with internal type door lock with common key for all the boxes and shall given maximum protection to the interior of the box.
The hinged design shall permit doors being completely removed when necessary.
- 4.1.08 The Feeder Pillar Box shall be suitable to mount on brick concrete foundation. Necessary provision for foundation bolt in the pillar shall be made for GI foundation bolts of size 12mm. Nuts, Bolts and 2 Nos. of Washers
- 4.1.09 The box shall be provided with suitable rain shed and all bolt and washers used shall be galvanized mild steel.
- 4.1.10 A danger board shall be provided in the front of the box.

4.2 EARTHING:

The box shall be provided with two Nos. of earthing points internally connected with accessible position on the sides. The earthing point shall be provided by 25 mm M8 bolts and nuts and marked with \perp symbol.

4.3 NAME PLATE AND CIRCUIT BOARD:

- 43.1 The Feeder Pillar Box shall be provided with transparent label or card of removable type and the following information are to be recorded.
- (1) Title
 - (2) Cable Size
 - (3) Current Rating of I/C Cable
 - (4) Current Rating of O/G Cable
 - (5) Current Rating of Fuse Links.
 - (6) No. of Outgoing Lines.
- 43.2 The label or card shall be fitted on the side of the door and circuit numbering means shall be indicated by symbol or diagram relating to the fuse ways.
- 43.3 The Circuit plate with following engraved information's has to be rivetted to the inside of the door of the feeder pillar box in an accessible position for easy reading.

Incoming Line from _____ :
 Incoming Line to _____ :
 Outgoing Line ___ Amps to _____ : (1-12)/ (1-8)

5.0 FABRICATION:

5.01 The feeder Pillar-Box shall be in conformity with the typical drawing in all respects.

5.02 The feeder pillar-Box shall comprise of the following accessories.

- (1) Feeder Pillar box Metal Body.
- (2) Copper / Aluminum bus bar.
- (3) Removable links.
- (4) Load break Switch.
- (5) Porcelain Re-wirable cut-outs.
- (6) Links.

5.1 FEEDER PILLAR BOX METAL BODY:

5.1.01 Feeder pillar box metal body shall be made out of high-grade MS sheet conforming to IS1079, with 3.00 mm thick for the body and 2.00 mm thick for the doors. The metal body shall be robust and painted complete with 2 coats of red-oxides on both sides as primary and LIGHT Grey paint with shade 631 of IS-5 for final finish.

5.2 BUS BARS:

5.2.01 Feeder pillar box shall be provided with insulated sleeved bus bar. The bus bar sizes as follows:

Load Break Switch Rating	8 WAY	12 WAY
630A	30 X 10 mm (300 Sq. mm) Copper	30 X 10 mm (300 Sq. mm) Copper
400 A	40 X 6 mm (240 Sq. mm) Copper	40 X 6mm (240 Sq. mm) Copper
400 A	40 X 10 mm (400 Sq. mm) Aluminum	40 X 10mm (400 Sq. mm) Aluminum

The insulated sleeves shall be of high grade with red, yellow and blue color for three phases and black for neutral.

5.2.02 The bus bar shall be made out of E.C. Grade Copper/ Aluminum flats. The bus bar shall be suitably supported on an insulating base rigidly fitted to the metal box.

5.2.03 The connection to the neutral bus bar is by means of socket. Necessary holes may be drilled on the bus bar for mounting the bus bar and extension.

5.3 FUSE LINK:

5.3.01 The feeder pillar box shall be provided with re-wirable porcelain cut out of reputed make and of the following rating:

Fuse Rating	8 WAY	12 WAY
32 A	4 Nos. Per Phase	-
63 A	3 Nos. Per Phase	10 Nos. Per Phase
100 A	1 No. Per Phase	2 Nos. Per Phase

5.3.02 The fuse carrier shall be non-inflammable and non- hygroscopic and the same shall have a hard glossy surface and shall conform to IS-2086/1993. The extended portion of the fuse carriers should be provided with galvanized M.S. Bolts and nuts. The design of the box shall be suitable for adding a minimum of 3 cut-outs on each side. The fuse cu-touts should be with extended terminal as shown in the drawing and be of rewirable type. Adequate contact pressure shall be provided in the cut-outs for carrying rated current without overheating. The fuse cut-outs shall be connected to the bus bar rigidly with aluminum strips of suitable size.

5.4 LOAD BREAK SWITCH:

Load break switch shall be suitable to work on 440 V, 400/630A, four pole 50HZ, heavy duty, front operated type, with replaceable silver plate contacts conforming to IS 4064/1978, superior type arc chambers with necessary insulating barriers and enclosed in a compact insulating cover. The switch shall be designed break the current of 400/630A and able to withstand breaking stresses with quick and reliable spring-loaded operating handle.

The location of operating handle shall be so as to facilitate convenient operation. The position of ON & OFF must be clearly indicated. The utilization category of the switch shall be Ac-23.

6.0 TEST & TEST CERTIFICATES AND INSPECTION:

6.1 The following routine tests shall be carried out on the panels at the factory:

- a) Checking of overall dimension, thickness of box sheet and paint film.
- b) Checking correctness of continuity of circuits.
- c) One-minute HV withstand test – All equipment's on panel and internal wiring shall be tested to withstand a test voltage of 2KV to earth for one minute.
- d) Insulation resistance of the complete circuit by circuit with all equipment's mounted on the panel using insulation Tester/Megger.
- e) Verification of degree of protection as per IS: 13947 (part-I).

6.2 The feeder pillar box shall be subjected to type test and acceptable test accessories with the standard to which it conforms.

6.3 All routine and acceptance tests shall be conducted in presence of the owner's representative. No material shall be dispatched unless the owner communicated his written approval to these test certificates.

6.4 Copies of the type and routine test certificates for all the components used in the manufacture of the box from a recognized test house (to prove the conformity of the components to the relevant standards)

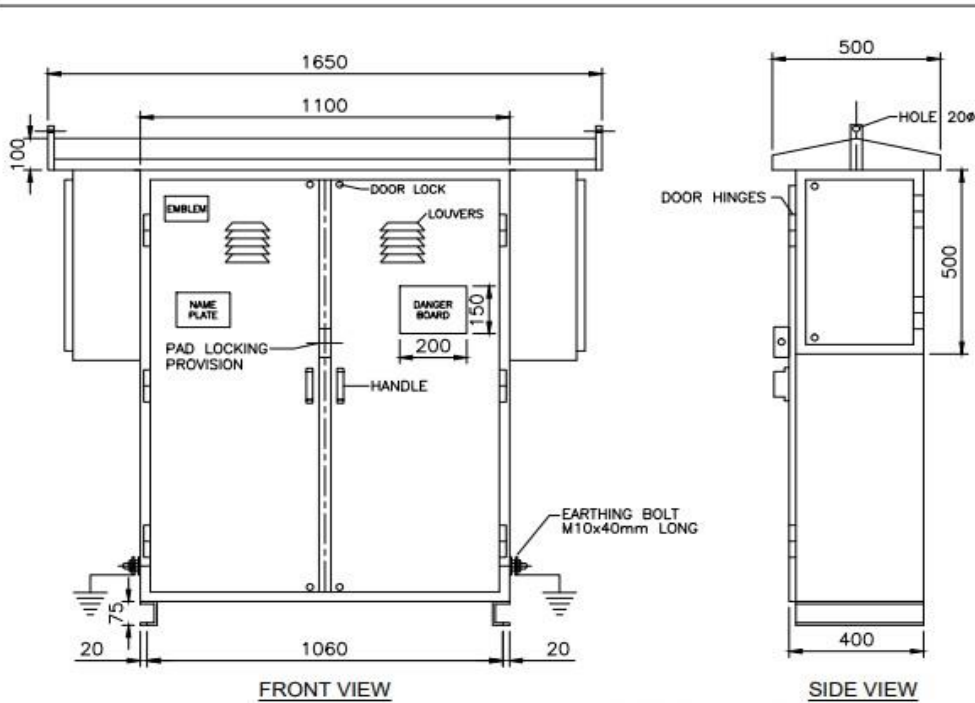

NOTES:-

1. THE BOX SHALL BE MADE OUT OF 3.0D(10SWG) SHEET EXCEPT DOOR SHALL BE OF 2.00 (14SWG) WITH CENTER STIFFNER PROVIDED.
2. THE BOX SHALL HAVE DOUBLE DOORS AND FITTED WITH INTERNAL TYPE DOOR LOCK WITH COMMON KEY FOR ALL THE BOXES.
3. THE BOX SHALL BE SUPPLIED WITH CHANNEL IN THE BOTTOM FIXED TO THE BOX HOLES FOR FOUNDATION BOLTS TO BE PROVIDED.
4. THE CUTOUTS SHALL BE OF RE-WIRABLE TYPE WITH EXTENDED TERMINAL.
5. THE EXPOSED PORTION OF THE BUS BARS SHOULD BE PROVIDED WITH INSULATING SLEEVES OF THE BEARING COLOURS OF R. Y. B AND BLACK FOR RESPECTIVE PHASES AND NEUTRAL.
6. TERMINAL STRIPS OF THE CUTOUTS OF 100A AND 63A MUST BE SUITABLY BENT TO THE SHAPE IF REQUIRED FOR PROPER FIXING.
7. THE BOX SHALL BE SUPPLIED WITH ENAMEL DANGER BOARD CONFORMING TO IS-2551.
8. THE BOX SHALL BE RUST PROOF, VERMIN PROOF AND WEATHER PROOF.
9. THE BOX SHALL BE PROVIDED WITH EARTHING WITH G.I BOLTS AND NUTS ON SLOTTED ANGLE IRON. (2 NOS. WITH SIGNS)
10. CABLE SHOULD BE PROVIDED BY SUITABLE SADDLE OF ANGLE IRON SUPPORTS.
11. CABLE ENTRY SHOULD BE AT SIDES OF THE BOX.
12. SWITCH TERMINAL SHOULD BE BENT EXTENDED AND STAGGERED SO THAT CABLE LEADS CAN BE FIXED DIRECT BY BOLT AND NUT WITHOUT BENDING.
13. ALL LIVE PARTS SHOULD BE SUFFICIENTLY INSULATED BY PVC INSULATING SLEEVES.
14. ARRANGEMENT OF FIXING HINGES TO THE DOORS MUST BE SUCH THAT DOOR CAN BE OPENED FULLY (160° MIN.) WITHOUT ANY DIFFICULTY. (AS SHOWN IN DRAWING).
15. THE BOX INCLUSIVE OF
 - (A) 1 NO, 400A/630A 3 PHASE, 4 POLE LOAD BREAK SWITCH L&T, SIEMENS, ENGLISH ELECTRIC & CROMPTON GREAVES MAKE.
 - (B) LINKS ON OTHER SIDE (PULLER TYPE LINK)

FUSE RATING	8 WAY	12 WAY
32A	4 Nos. Per Phase	-
63A	3 Nos. Per Phase	10 Nos. Per Phase
100A	1 No. Per Phase	2 Nos. Per Phase

16. SIZE OF BUS BARS (COPPER/ALUMINIUM FOR 400A/630A CIRCUIT BREAKER)
A. 30x3mm G.I PLATED M.S EARTH BUS.

8WAY & 12WAY BUSBAR DETAILS

LBS RATING	8 WAY	12 WAY
630A	30x10mm (300sqmm) Copper	30x10mm (300sqmm) Copper
400A	40x10mm (240sqmm) Copper	40x6mm (240sqmm) Copper
400A	30x10mm (400sqmm) Alu	40x10mm (400sqmm) Alu

REFERENCE STANDARDS:- (Latest Editions)

1. M.S SHEET	IS-1079
2. REWIRABLE TYPE PORCELAIN CUTOUTS.	IS-2086
3. DANGER BOARD.	IS-2551
4. PAINT - SHADE 631	IS-5
5. LOAD BREAK SWITCH	IS-4064

DOOR THE DOOR SHALL BE SELF CLOSING TYPE WITH SPRING ARRANGEMENT.

17. DIMENSIONS SHOWN ARE INDICATIVE, SUBJECT TO CHANGE AS PER DIMENSIONS OF THE VARIOUS COMPONENTS OFFERED.
18. PROVISION FOR CLAMP TO FIX 100mm DIA, PVC PIPE IS TO PROVIDED FOR CABLES.

Chd	<i>[Signature]</i> AEM (QS&S)	All dimensions are in mm unless otherwise stated. DETAILS OF 8/12 WAY L.T FEEDER PILLAR BOX SHEET 1 OF 2	 Approved:
Sub	<i>[Signature]</i> DGM (QS&S)		
SCALE: N.T.S			DRG.NO.BESCOM/GM/QS&S/41 REV-002 DATED:24-11-2018

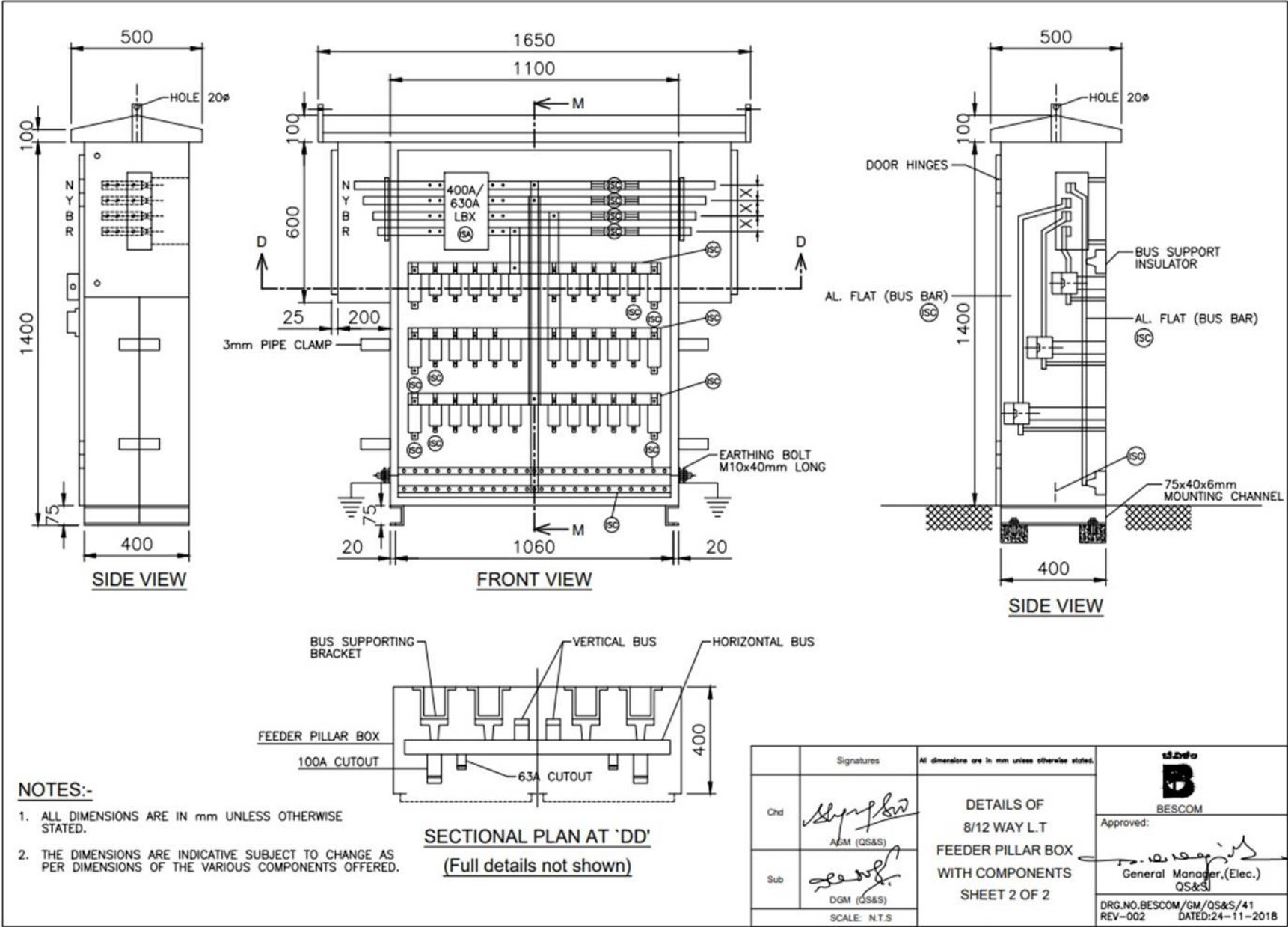

SECTION – 11

SPUN POLE

TECHNICAL SPECIFICATION FOR SPUN CONCRETE POLES

1) SCOPE:

This specification covers design manufacture testing and supply of pre stressed concrete circular spun poles/designed for a working load of 500 Kgs.

2) Applicable Standards:

The poles shall comply with the relevant provisions made in the following Indian Standards Specifications or the latest versions thereof, except when they conflict with the specific requirements in this specific requirement in this specification.

- a. IS 1678-1978 – Specification for the stressed concrete poles for overhead power, traction and telecommunication lines.
- b. IS 2905-1966 – Methods of test for concrete poles for overhead power and telecommunication lines.
- c. IS 7321-1974 – Code of practice for selection, handling and erection of concrete poles for overhead power and telecommunication lines.
- d. IS **13158**-1991 – Pre stressed concrete circular spun poles for overhead power.

Materials meeting any other authoritative standards which ensure an equal or better quality than the standards mentioned above will also be acceptable. In such cases, English version of the standard adopted should be furnished prior to supply.

3) Terminology:

For the purpose of this specification, the definitions of Average Permanent Load, Load Factor and Transverse Load at first crack, Ultimate Failure, Ultimate Transverse Load and Working Load shall be as per IS 1678 or any other equivalent International Standards.

4) Dimensions and Shape:

The poles shall be of hollow circular section with an outside taper of 1:65. The diameter and thickness shall be as per design requirements. The tolerances shall be as follows:

Outer diameter	+4,	(-) 2mm
Length	+50,	(-) 10mm

5) Cement:

- 5.1. High strength ordinary Portland cement conforming to IS:8112 or ordinary Portland Cement conforming to IS: 269-1976 or rapid hardening cement conforming to IS-804 1 E-1978 or any other equivalent International Standards shall be used, which shall have the following additional requirements:

- a) Initial Setting Time : Not less than 30 minutes.
- b) Final Setting Time : Not more than 600 minutes.

5.2 The minimum compressive strength of standard mortar cube with standard sand as per IS:650 at 7 days shall be 375 Kgs/cm square.

A minimum of 3 trial cubes shall be made with aggregate grading to be used for the approved design mix and the average compressive strength results at 7 days, shall be determined to assess the suitability of the cement for every batch of cement.

6) Aggregates:

Coarse and fine aggregates used for the casting of poles shall conform to IS:383 or any other equivalent international Standards. The nominal max size of aggregates shall in no case exceed 20 mm or 1/4th the minimum thickness of the pole, whichever is less., provided further that the size of aggregates shall be at least 5mm less than the spacing between the pre-stressing wires.

Each size of graded aggregate shall be stocked in different storage bins or stock piles and shall be mixed only after the quantity required for each size has been separately weighed. The storage bins or stock piles shall be under cover to protect from weather.

7) Water:

Water should be free from chlorides, sulphates, other salts and organic matter Potable water will be generally suitable.

8) Admixtures:

Admixtures should not contain calcium chloride or other chlorides and salts which are likely to promote corrosion of pre-stressing steel.

9) Reinforcement:

9.1 Reinforcing bars and wires used for the manufacture of prestressed concrete poles shall conform to the following Indian Standards or any other equivalent International Standards.

- a. IS:1785(Part-I) Specification for plain hard drawn steel wire for prestressed concrete: Part-I cold-drawn stress relieved wire (second revision).
- b. IS:1785(Part-II) – 1983 Specification for plain hard drawn steel wire for pre stressed concrete: Part-II as drawn wire (First revision).
- c. IS:2090-1983 – Specification for high tensile steel bars used in pre stressed concrete (first revision).

- d. IS:6003-1983 Specification for indented wire for prestressed concrete (first revision)
 - e. IS:6006-1983 specification for uncoated stress relieved strand pre stressed concrete (first revision).
- 9.2 The surface of all reinforcement shall be free from loose scale, oil, grease, clay or other material that may have deteriorated effect on the bond between the reinforcement and the concrete.

10) Concrete:

The concrete mix shall be designed to the requirement laid down for controlled concrete (also called design mix concrete) in IS-1343 (code of practice for pre stressed concrete) and IS-456 (code of practice for plain and reinforced concrete) or any other equivalent international standards subject to the following special conditions.

- a. Minimum works cube strength at 28 days should be at least 50N/mm square.
- b. The concrete strength at transfer should be at least half the 28 days strength ensured in the design.

11) Design Requirements:

The pole shall be designed for the following requirements:

- a. Factor of safety for the poles shall not be less than 2.0
- b. The average permanent load shall be taken as 50% of the working load.
- c. The F.O.S. against first crack load shall be 1.0
- d. At average permanent load, permissible tensile stress in concrete shall be 3.0 N/mm square.
- e. At the design value of first crack load, the hypothetical flexural tensile stress of M 50 concrete grade shall not exceed 6.3 N/mm square.
- f. The maximum compressive stress in concrete at the time of transfer of pre stress shall not exceed 0.8 times the cube strength.

12) Moulds:

Moulds shall be of steel and or rigid construction to prevent distortion and so arranged as to provide smooth surfaces. The moulds shall not allow any leakage of cement grout during casting. The holes in the end plates for the HT wires shall be accurately drilled by jigs to ensure inter-changeability. The end plates shall be designed to withstand the forces arising out of the change in direction of pre-stressing wires during tensioning.

13) Tensioning of Wires:

- 13.1 The HT wires shall be placed axially at regular spacing along the circumference. The spacing shall be as per IS 1678 or any other equivalent to International Standards. While cutting in of HT wires will be by automatic machines, button heading and forming reinforcement cages shall be done manually.
- 13.2 Helical steel shall be 2.7mm dia MS wires and the pitch shall be 150mm.
- 13.3 The clear cover shall be 20mm
- 13.4 Pre-stressing shall be by automatic machines. Force shall be applied on the entire group of HT wires to ensure all wires are equally stressed.
- 13.5 The pre-stressing wires shall be stretched by an approved method. The anchoring of the stretched wires shall be such that during manufacture and until the wires are released, no slipping occurs. The force at the time of initial stretching shall in addition to imparting of designed prestress also be sufficient to overcome the friction on account of any change in the inclination of wires and slippage that might occur during the anchoring process which will have to be suitably compensated.
- 13.6 The tensioning of pre-stressing steel shall be carried out in a manner that will induce a smooth and even rate of increase of stress in the wires.
- 13.7 The force induced in the pre-stressing wires shall be determined by means of gauges attached to the tensioning apparatus and cross checked by extension to be achieved shall be determined in advance, based on trials conducted on representative samples of the wires as used in the poles. The accuracy of the devices for measuring of the tensioning force shall be within plus or minus 5%.

14) Mixing and Consolidation of Concrete.

- 14.1 Provision shall be made to measure the quantities of cement and of fine and coarse aggregates by weight only. The accuracy of the measuring equipment shall be plus or minus 3%. All the measuring equipment's shall be maintained in clean, serviceable condition and its accuracy checked regularly. Modern high speed mixers, preferably pan or turbine type shall be used for mixing the concrete.
- 14.2 The manufacture of poles shall be done under suitable cover and not in the open.
- 14.3 The concrete shall be thoroughly mixed and consolidated.
- 14.4 The freshly cast poles shall be protected during the first stage of hardening from the harmful effects of sunshine, dry winds, cold and rains.

15) De tensioning of Wires:

- 15.1 The anchoring system shall provide a device for gradual de tensioning of the wires. No back pulling of the wires shall be permitted in the gradual de tensioning device for the purpose of release of any wedge or other parts of the

de tensioning device. Flame cutting of the wires before release of the full tension shall be strictly prohibited.

- 15.2** The transfer of prestress shall not be effected until the concrete in the poles has attained the specified as established of cube tests.

16) Curing:

- 16.1 The curing shall be done on a saturated steam at 65 degree centigrade to ensure that 80% ultimate strength is reached in 6 hours. Thereafter the HT wires will be cut, poles demoulded and transferred to water for 14 days curing.
- 16.2 During manufacture, periodical tests on concrete cubes of preferably spun hollow cylindrical specimen measuring 200mm in dia and 300mm in height shall be carried out till the concrete achieves the required strength at transfer. Thereafter the test on concrete shall be carried out as detailed in IS:1343 or any other equivalent international standards. The manufacturer shall supply when required by the purchaser results of compressive test conducted in accordance with IS:456 or any other equivalent International Standards on concrete cubes made from the concrete used for the poles. If the purchaser so desires the manufacturer shall supply cubes for test purpose and such cubes shall be tested in accordance with IS:456 or nay other equivalent International Standards.

17) Earthing:

- 17.1 Earthing shall be provided by 6mm Φ MS Earth Rod embedded in Concrete with M16 MS Nut as shown in Drawing.
- 17.2 Earth wire shall not be allowed to come in contact with the prestressing wires.

18) Finish:

- 18.1 Poles shall be free from surface defects including hair cracks. The surface of the poles in contact with the steel mould shall be smooth and regular in shape and shall as far as possible, be free from pores. Water retaining pockets or honey-combing formation shall not be admissible. 25mm thick 1:2 cement mortar cover shall be provided on the full area of the top of pole.
- 18.2 The ends of the prestressing wire shall be cut as close to the surface of the pole as possible and in any case shall not project more than 3mm.
- 18.3 The ends of the prestressing wire shall be given two coats of suitable anti-corrosive paints approved by the purchaser.
- 18.4 No touching up or finishing by cement grout, etc., shall be done on the poles after it is removed from the moulds.
- 18.5 A metallic base plate shall be provided at the bottom of pole.

19) Welding and Lapping of Steel:

The high tensile steel wire shall be continuous over the entire length of the tendon. Welding shall not be allowed in any case. However, joining or coupling may be permitted provided the strength of the joint of coupling is not less than the strength of each individual wire.

20) Provision of Holes & Hooks:

- 20.1 Through holes shall be provided for fixing cross arms and top clamp as specified by purchaser.
- 20.2 PVC inserts shall be provided at intervals of 600mm on alternate sides for fixing up of step bolts along the length of pole.
- 20.3 A set of step up bolts shall be supplied along with each lot of 100 poles.

21) Tests:

- 21.1 During manufacture, tests on concrete shall be carried out as detailed in clause 16.2 of this specification.
- 21.2 Transverse strength test.
 - 21.2.1 Poles made of ordinary Portland cement shall be tested on the completion of 28 days and poles made from rapid hardening cement only on the completion of 14 days after the day of manufacture.
 - 21.2.2 The pole may be tested in either horizontal or vertical position. If tested in horizontal position, provision shall be made to compensate for the overhanging weight of the pole. For this purpose, the overhanging portion of the pole may be supported on a movable trolley or similar device.
 - 21.2.3 The pole shall be rigidly supported at the butt end for a distance equal to the agreed depth of planting i.e. 1.8 mtr.
 - 21.2.4 Load shall be applied at a point 600mm from the top of the pole and shall be steadily and gradually increased to the design value of the transverse load at first crack. The deflection at this load shall be measured.
 - 21.2.5 A pre-stressed concrete pole shall be deemed not to have passed the test if visible cracks appear at a stage prior to the application of the design transverse load for the first crack.
 - 21.2.6 The load shall then be reduced to zero and increased gradually to a load equal to the first crack load plus 10% of the minimum ultimate transverse load and held up for 2 minutes. This procedure shall be repeated until the load reaches the value of 80% of the minimum ultimate transverse load and thereafter increased by 5% of the minimum ultimate transverse load until failure occurs. Each time the load is applied, it shall be held for 2 minutes. The load applied to

pre-stressed concrete pole at the point of failure and shall be measured to the nearest five kilograms.

- 21.2.7 The pole shall be deemed not to have passed the test if the observed ultimate transverse load is less than the designed ultimate transverse load.

22) Sampling and Testing:

22.1 scale of sampling:

22.1.1 Lot-In a consignment, 500 poles or part there of the same mounting height, same dimensions and belonging to the same batch of manufacture, shall be grouped together to constitute a lot.

22.1.1.1 Sub-Lot: If the number of poles in a lot exceeds 500, the lot shall be divided into a suitable number of sub-lots such that the number of poles if any, sub-lot shall not exceed 500. The acceptance or otherwise of a sub lot shall be determined on the basis of the performance of samples selected from it.

22.1.2 The number of poles to be selected from a lot or a sub lot shall depend upon its size and shall be in accordance with col. 1 and 2 of the following table:

Size of lot	Dimensional Requirement		
	Sample Size	Permissible No. of Defective Samples	No. of poles for transverse strength test
(1)	(2)	(3)	(4)
Upto 100	10	1	(*)
101 to 200	15	1	3
201 to 300	20	2	4
301 to 500	30	3	5

(*) The No. of Poles to be tested shall be subject to confirmation by inspecting staff.

22.1.3 These poles shall be selected at random, in order to ensure randomness, all the poles in the lot or the sub-lot may be arranged in a serial order and starting from any random pole, every 'r'th pole may be included in the sample, 'r' being the integral part of N/n where N is the size of the lot or the sub-lot and 'n' is the sample size.

22.2 Number of Tests:

22.2.1 All the poles as selected in 22.1.2 shall be tested for overall length, cross-section and uprightness. The permissible tolerances shall be +/- 15 mm on over all length, +/- 3mm on cross sectional dimensions and 0.5% on uprightness.

22.2.2 The number of poles to be tested for transverse strength test shall be in accordance with col. 4 of the table in 22.1.2. These poles may be selected from those already tested in 22.2.1.

22.3 Criteria for Conformity:

- 22.3.1 A lot or sub-lot shall be considered as conforming to this specification if the conditions under 22.3.2 and 22.3.3 are satisfied.
- 22.3.2 The number of poles which do not satisfy the requirements of overall length, cross-section and uprightness shall not exceed the corresponding number given in col.3 of the Table under clause 22.1.02. If the number of such poles exceeds the corresponding number, all poles in the lot or sub-lot shall be tested for these requirements., and those not satisfying the requirements shall be rejected.
- 22.3.3 All the poles tested for transverse strength test shall satisfy the requirements of the test, if one or more poles fail, twice the number of poles originally tested, shall be selected form those already selected and subjected to the test. If there is no failure among these poles, the lot or the sub-lot shall be considered to have satisfied requirements of this test.

23) Marking:

The poles shall be clearly engraved and indelibly marked with the following particulars either during or after manufacture but before testing at a position so as to easily read after erection in position:

- a. Month and year of manufacture.
- b. Transverse strength of pole in kg.
- c. Serial number of the pole.
- d. Position of center of Gravity of the pole with the word C.G.
- e. Line indicating depth of planting.
- f. BESCO

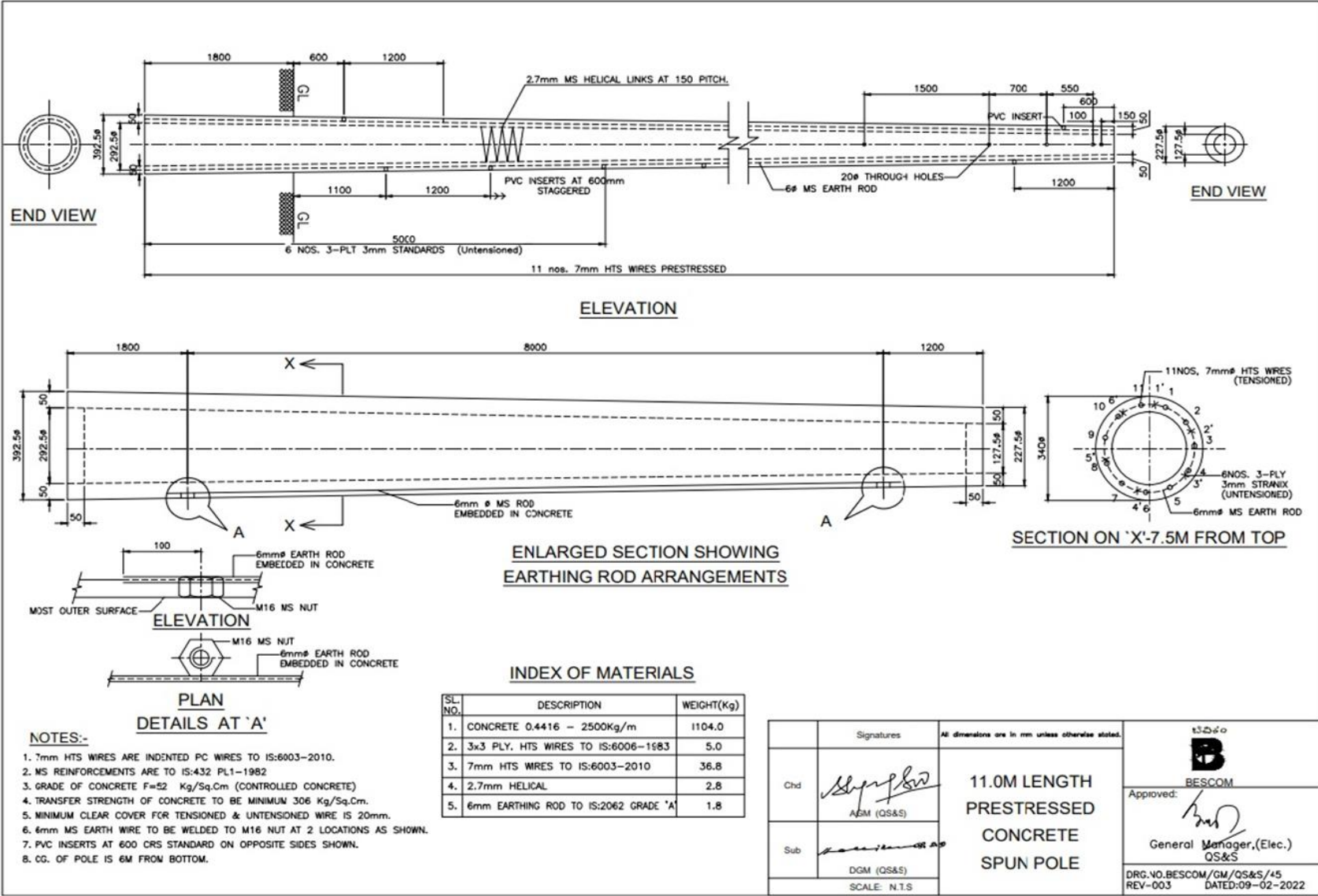

SECTION -12

PSCC POLE

TECHNICAL SPECIFICATIONS FOR PRESTRESSED CEMENT CONCRETE POLES (9Mtr PSCC Pole with working Load of 300Kg)

SCOPE:

- 1.1 This Specification covers the manufacture as per designs, testing and supply of 9Mtr Long Pre-stressed Cement Concrete Poles (PSCC) - 300 Kg Working Load.
The poles shall be manufactured according to REC Standard with Working Load of 300Kg. (designed, tested, and approved by the cement Research Institute of India) the details of which are furnished in the drawings enclosed.

2.0 APPLICABLE STANDARDS

- 2.1 Except when they conflict with specific requirement in this specification, the poles shall comply with the relevant provisions made in the latest version of the following Indian Standards specifications:
- a) IS 1678/1998 Specification for pre-stressed concrete poles for overhead power, traction and telecommunication lines.
 - b) IS 2905/1989 Methods of tests for concrete poles for overhead power and telecommunication lines.
 - c) IS 7321/1974 Code of practice for selection, handling and erection of concrete poles for overhead power and telecommunication lines.

3.0 MATERIALS

- 3.1 **Cement:** The cement used in the manufacture of pre-stressed concrete poles shall be any one of the following 53-grade ordinary Portland cement conforming to IS 12269.
- a) Portland slag cement conforming to IS 455 but with not more than 50 percent slag content.
 - b) Rapid hardening Portland cement conforming to IS 8041.
 - c) 43 grade ordinary Portland cement conforming to IS 8112, and
 - d) 53 grade ordinary Portland cement conforming to IS 12269.
- 3.2 **Aggregates:** Aggregates used for manufacture of pre-stressed concrete poles shall conform to IS: 383 (Specification for coarse and fine aggregates from natural sources for concrete). The nominal maximum size of aggregates shall in no case exceed 12 mm.
- 3.3 **Water:** Water shall be free from chlorides, Sulphate, other salts and organic matter. Potable water will be generally suitable.
- 3.4 **Admixtures:** Admixtures should not contain chlorides in any form are likely to promote corrosion of pre-stressing steel. Admixtures shall conform to IS: 9103 (Specification for admixtures for concrete).
- 3.5 **Pre-stressing steel:** The pre-stressing steel wires, including those used as untensioned

wires, should conform to any one of the following:

1. IS 1785 (Part-I) Specification for plain hard-drawn steel wire for pre-stressed concrete. Part-I-Cold drawn stress relieved wire,
2. IS: 1785 (Part-II) Specification for plain hard drawn steel wire for pre-stressed concrete, Part-II. As drawn wire, or
3. IS 6003 Specification for indented wire for pre-stressed concrete,
4. Uncoated stress relieved strand conforming to IS 6006 or IS 14268
5. High tensile steel bar conforming to IS 2090

The type designs given are for plain wires of 4 mm. dia. with guaranteed ultimate strength of 175 Kg / mm². All pre-stressing steel shall be free from splits, harmful stretches, surface flaws, rough, aged and imperfect edges and other defects likely to impair its use in Pre-stressed concrete.

4.0 CONCRETE MIX:

4.1 The concrete mix shall be designed to the requirement laid down for controlled concrete (also called design mix concrete) in IS:1343 Code of practice for pre-stressed concrete and IS:456 Code of practice for plain and reinforced concrete, Subject to the following special conditions:

- a) Minimum works cube strength at 28 days should be at least 420 Kg./Cm².
- b) The concrete strength at transfer shall not be less than half the 28 days strength ensured in the design, i.e., $420 \times 0.5 = 210$ Kg/Cm².
- d) The mix should contain atleast 360 Kgs. of cement per cubic meter of concrete.
- e) The mix should contain low water content as is consistent with adequate workability. If it becomes necessary to add water to increase the workability the cement content also should be raised in such a way that the original value of water cement ratio is maintained.

5.0 DESIGN REQUIREMENTS:

5.1 The poles shall be designed for the following requirements:

- a) The poles shall be planted directly in the ground with a planting depth as indicated in drawing i.e., 1.7 M. for 9 M. poles
- b) The poles should be suitable to take up a load of 300 Kg. applied at 0.6 M. from top.
- c) The factor of safety for all these poles shall not be less than 2.0.
- d) The average permanent load shall be 40% of the working load.
- e) The FOS against first crack load shall be 1.0.
- f) In the design value of first crack load the modulus of rupture shall not exceed 55.2 Kg sq.cm for M-40 concrete.

- g) At average permanent load, permissible tensile stress in concrete shall be 30 Kg/Cm².
- h) The ultimate moment capacity in the longitudinal direction should be at least one fourth of that in the transverse direction.
- i) The maximum compressive stress in concrete at the time of transfer of pre-stress should not exceed 0.8 times the cube strength.
- j) The concrete strength at transfer shall not be less than half the 28 days strength ensured in the design, i.e., $420 \times 0.5 = 210$ Kg/Cm².
- k) The Poles shall be manufactured as per the enclosed drawings.

6.0 DIMENSIONS AND REINFORCEMENTS:

- 6.1 The cross sectional dimensions and the details of pre-stressing wire should conform to the particulars as per drawings.
- 6.2 The provisions of holes for fixing cross arms and other fixtures should conform to the construction practice adopted by BESCO.

7.0 MANUFACTURE:

- 7.1 All pre-stressing wires and reinforcements shall be accurately fixed as shown in the drawings and maintained in position during manufacture. The un-tensioned reinforcement, as indicated in the drawings, should be held in position by the use of stirrups, which should go round all the wires.
- 7.2 All wires shall be accurately stretched with uniform pre-stress in each wire. Each wire or group of wires shall be anchored positively during casting. Care shall be taken to see that the anchorage does not yield before the concrete attains the necessary strength.
- 7.3 Cover: The cover of concrete measured from the outside of the pre-stressing tendon shall be normally 20 mm.
- 7.4 Welding & lapping of steel: The high tensile steel wire shall be continuous over the entire length of the tendon. Welding shall not be allowed in any case. However, jointing or coupling may be permitted provided the strength of the joint or coupling is not less than the strength of each individual wire.
- 7.5 Compacting: Concrete shall be compacted by spinning, vibrating shocking or other suitable mechanical means. Hand compaction shall not be permitted.
- 7.6 Curing: The concrete shall be covered with a layer of sacking, canvas, hessian or similar absorbent material and kept constantly wet up to the time when the strength of concrete is at least equal to the minimum strength of concrete at transfer of pre-stress. Thereafter, the pole may be removed from the mould and watered at intervals to prevent surface cracking of the unit, the interval should depend on the atmospheric humidity and temperature.
- 7.7 The pre-stressing wires shall be de-tensioned only after the concrete has attained the

specified strength at transfer (i.e., 210 Kg/Cm²). The cubes cast for the purpose of determining the strength at transfer should be cured, as far as possible under conditions similar to those under which the poles are cured. The transfer stage shall be determined based on the daily tests carried out on concrete cubes till the specified strength indicated above is reached. Thereafter the test on concrete shall be carried out as detailed in IS 1343 Code of practice for pre-stressed concrete. The manufacturer shall supply when required by the Engineer or his representative, results of compressive test conducted in accordance with IS: 456 Code of practice for plain and reinforced concrete on concrete cubes made from the concrete used for the poles. If the Engineer so desires, the manufacturer shall supply cubes for test purposes and such cubes shall be tested in accordance with IS: 456 Code of practice for plain and reinforced concrete. The de-tensioning shall be done by slowly releasing the wires, without imparting shock or sudden load to the poles. The rate of de-tensioning may be controlled by any suitable means either mechanical (Screw type) or hydraulic. The poles shall not be de-tensioned or released by cutting the pre-stressing wires using flames or bar croppers while the wires are still under tension.

7.8 Stacking should be done in such a manner that the broad side of the pole is vertical. Each tier in the stack should be supported on timber sleepers located at 0.15 times the overall length, measured from the end. The timber supports in the stack should be aligned in a vertical line.

7.9 Poles should be transported with their broad faces placed vertically and in such a manner that shocks are avoided. The supports should be so arranged that they are located approximately at a distance equal to 0.15 times the overall length, from the ends. The erection of the pole should be carried out in such a way that the erection loads are applied so as to cause moment with respect to the major axis, i.e., the rope used for hoisting the pole should be parallel to the broader face of the pole.

8.0 EARTHING:

8.1 Earthing shall be provided by having a separate length of 4 mm dia GI Wire embedded in concrete during manufacture and the ends of wire left projecting from the burrow end of the pole to a length of 100 mm at 215 mm from top of the pole and 150 mm below ground level. The arrangement for termination of the earth wire and fixing of the bolt and nut shall be as indicated in the enclosed drawings. The Wire used for embedding shall comply with the requirement of IS-2141/2000.

9.0 TESTS:

9.1 Transverse Strength Tests: Poles made from ordinary Portland cement shall be tested only on the completion of 28 days and poles made from rapid hardening cement, only on the completion of 14 days, after the day of manufacture.

- 9.2 The pole may be tested in either horizontal or vertical position. If tested in horizontal position, provisions shall be made to compensate for the overhanging weight of the pole. For this purpose, the overhanging portion of the pole may be supported on a movable trolley or similar device.
- 9.3 The pole shall be rigidly supported at the butt end for a distance equal to the depth of planting i.e., 1.7 meter for 9 meter poles.
- 9.4 Load shall be applied to at a point 600 mm from the top of the pole and shall be steadily and gradually increased to the design value of the transverse load for the first crack.
- 9.5 A Prestressed concrete pole shall be deemed not to have passed the test if visible cracks appear at a stage prior to the application of the design transverse load for the first crack.
- 9.6 The load shall then be reduced to a zero and increased gradually to a load equal to the first crack load plus 10% of the minimum ultimate transverse load, and held up for 2 minutes. This procedure shall be repeated until the load reaches a value of 80% of the minimum ultimate transverse load and thereafter increased by 5% of the minimum ultimate transverse load until failure occurs. Each time the load is applied, it shall be held for 2 minutes. The load applied to Prestressed concrete pole at the point of failure shall be measured to the nearest five kilograms.
- 9.7 The pole shall be deemed not to have passed the test if the observed ultimate transverse load is less than the design ultimate transverse load.
- 9.8 Destruction Test: One pole out of a lot of 500 or less shall be subjected to destruction test to verify the steel and other aggregates used. No payment shall be made for the pole / poles which are subject to Destruction test.

10.0 MEASUREMENT OF COVER:

- 10.1 After completion of the transverse strength test, the sample pole shall be taken and checked for cover. The cover of the pole shall be measured at 3 points, one within 1.8 meters from the butt end of the pole, the second within 0.6 mtr. From the top and the third at an intermediate point and the mean value compared with the specified value.
- 10.2 The mean value of the measured cover should not differ by more than +/- 1 mm. from the specified cover. The individual values should not differ by more than +/- 3 mm. from the specified value. If these requirements are not met, the workmanship with reference to aligning of the end plates and per-stressing wires and assembly of moulds should be improved and inspection at production stage tightened suitably.

11.0 SCALE OF SAMPLING:

- 11.1 **Lot:** In any batch, all poles of the same class and same dimensions shall be grouped together to constitute a lot.
- 11.2 **Sub-Lot:** If the number of poles in a lot exceeds 500, the lot shall be divided into a suitable number of sub-lots such that the number of poles in any sub-lot shall not exceed 500. The

acceptance or otherwise of a sub-lot shall be determined on the basis of the performance of samples selected from it.

- 3.1 The number of poles to be selected from a lot or a sub-lot shall depend upon its size and shall be in accordance with Col. 1 and 2 of the following table

No. of poles in the Lot 1	Sample Size 2	Dimensional Requirement Acceptance Number 3	Transverse Strength Test 4	Transverse Strength Ultimate 5
Up to 100	10	1	2	1
101 to 200	15	1	3	1
201 to 300	20	2	4	1
301 to 500	30	3	5	2

The poles shall be selected at random. In order to ensure randomness, all the poles in the lot of the sub-lot may be arranged in a serial order and starting from any random pole, every 7th pole may be included in the sample 'r' being the integral part of N/n where 'N' is the size of the sub-lot and 'n' is the sample size.

4.0 NUMBER OF TESTS :

- 4.1 All the poles as selected in accordance with Clause 11.3 shall be checked for overall length, cross section and uprightness. The tolerance shall be +/- 15 mm. on overall length, +/- 3 mm. on cross sectional dimensions and 0.5 % on uprightness.
- 4.2 The number of poles to be tested for transverse strength test shall be in accordance with column-4 of the above Table. These poles may be selected from those already tested.

5.0 CRITERIA FOR CONFORMITY:

- 5.1 A lot or sub-lot shall be considered as conforming to this specification if the conditions under 11.1 and 11.2 are satisfied.
- 5.2 The number of poles, which do not satisfy the requirements of overall length, cross section and uprightness, shall not exceed the corresponding number given in column 3 of Table. If the number of such poles exceeds the corresponding number, all poles in the lot or Sub-lot shall be tested for these requirements, and those not satisfying the requirements shall be rejected.
- 5.3 All the poles tested for transverse strength test shall satisfy the requirements of the test. If one or more poles fail, twice the number of poles originally tested shall be selected from those already selected and subjected to the test. If there is no failure among these poles, the lot or the sub-lot shall be considered to have satisfied the requirements of this test.

NOTE: No payment will be made for the tested pole, which fails or poles, which are tested

to destruction.

6.0 **MARKING:**

6.1 The pole shall be clearly engraved and indelibly marked with the following particulars during manufacture but before testing at a position so as to be easily read after erection in position.

- a. Month and year of manufacture
- b. Transverse strength of pole in Kg
- c. Makers Sl. No. And mark
- d. Line indicating depth of planting at 1.7mtr.
- e. Engraved letters indicating BESCO.
- f. P.O. No. / Date
- g. Any other details as specified.

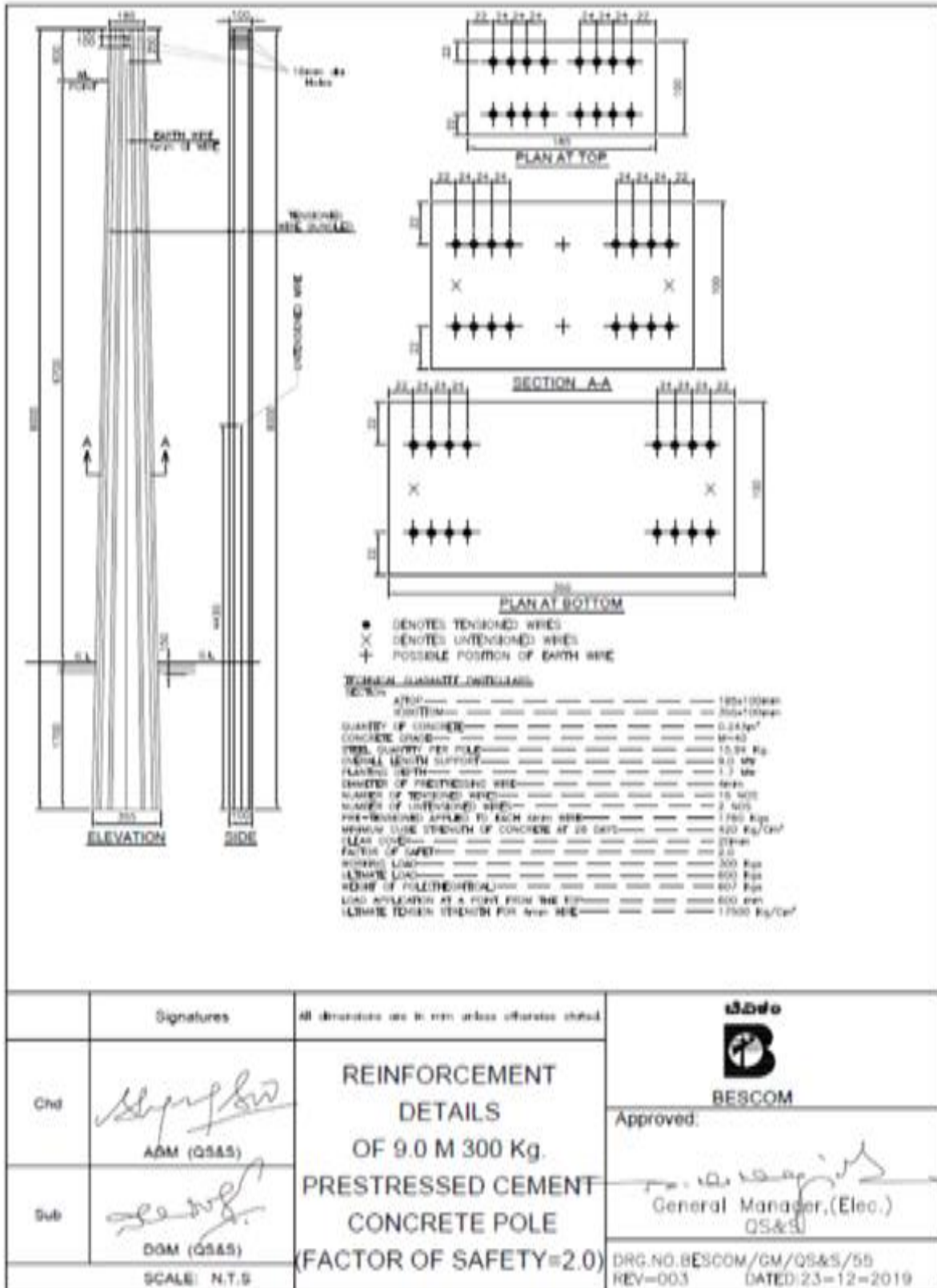

SECTION -13
EARTHING ARRANGEMENTS

1. EARTHING ARRANGEMENTS:

Perforated steel galvanised pipe of 'C' class of 40mm dia, 2.9mm thick and 2500 mm long shall be erected in an earth pit as shown in drawing below. The earth wire used shall be of GI strip of size 25mm x 3mm/ 8 SWG GI Wire whichever is required with suitable clamping of size not less than 25 x 3mm on to the terminal structure and embedded in concrete for raising to the top of terminal structure. Both ends of the GI strip/GI Wire should be fixed with GI bolts, nuts and spring washer. The funnel shall be enclosed in a CC chamber of size 400x400x400mm with a cast iron cover. Earth box shall be painted above the ground level to facilitate painting of earth values. The earth electrode shall have staggered holes of 12mm dia and the pit shall be filled with alternate layers of charcoal and salt of thickness 150 mm surrounding the pipe. The earth value when measured individually and combined should be less than 10 ohms. Earth resistance value in ohms, earth pit No. and date of testing to be painted in the plinth by white paint. Supply of GI pipe and all accessories for earthing (excluding GI wire/ flat) is included in the scope of work for earthing arrangements.

44.1 Scope:

This section of the specification covers the supply, erection, testing and commissioning of Galvanized Iron Earthing Strips for the Distribution Network equipment's.

44.2 Applicable Standards:

The galvanizing and testing of materials shall confirm to the latest edition of the following standards except otherwise specified in the specification. Recommended practice for hot dip galvanized of Iron Earthing Strips	IS: 2629(1966)
Methods of testing weight, thickness & uniformity of coating on hot dip galvanized articles	IS: 2633(1972)
Specification for hot dip galvanized coating on fastness	IS: 5358(1969)
Specification for Electroplating	IS:3203
Specification for hot dip Zinc coating on structural & other allied products	IS: 4759(1968)

44.3 General Technical Requirements:**MATERIAL**

Supplier has to purchase raw materials (MS Flat) as per relevant IS at his own cost. The zinc required for galvanizing shall be quality Zn-98 & shall confirm to IS: 209 - 1966 and its latest amendments. The Supplier shall make his own arrangement for procurement before the commissioning of work, sufficient quantity of electrolytic zinc of proper quality for galvanizing. The Supplier shall however, not link the delivery period with the supply of zinc. The KRIDE is at liberty to have sample of zinc used and to test in any laboratory at his own cost and reject the particular supply, is found below standard. All raw materials required for galvanizing etc. and for complete execution of work shall be stocked in adequate quantities by the Supplier to ensure that the progress of work is not hampered.

GALVANISING

Fully galvanized Iron strips shall be used. Galvanized Iron strips shall confirm to IS: 2629 (1966). The zinc deposition should not be less than 610 grams/meter square of the galvanized surface area of the MS Earthing strips. All galvanized materials shall withstand test as

per IS: 2633 (1972). The weight of zinc coating shall determine as per the method stipulated in IS: 2633(1964). The standard length of Galvanized Iron Earthing Strip shall be minimum 7 Mtrs and not exceeding 10 Mtrs.

1. Precautions:

Earthing system shall be mechanically robust and the joints shall be capable of retaining low resistance even after subjections to fault currents.

Joints shall be tinned, soldered and/or double riveted. All the joints shall be mechanically and electrically continuous and effective. Joints shall be protected against corrosion.

2. Testing:

On the completion of the entire installation, the following tests shall be conducted:

- i) Earth resistance of electrodes
- ii) Impedance of earth continuity conductors as per BIS.
- iii) Effectiveness of earthing as per BIS.

All meters, instruments and labour required for the tests shall be provided by the contractor. The tests results shall be submitted in the prescribed tabulated form in triplicate to the consultants

for

approval.

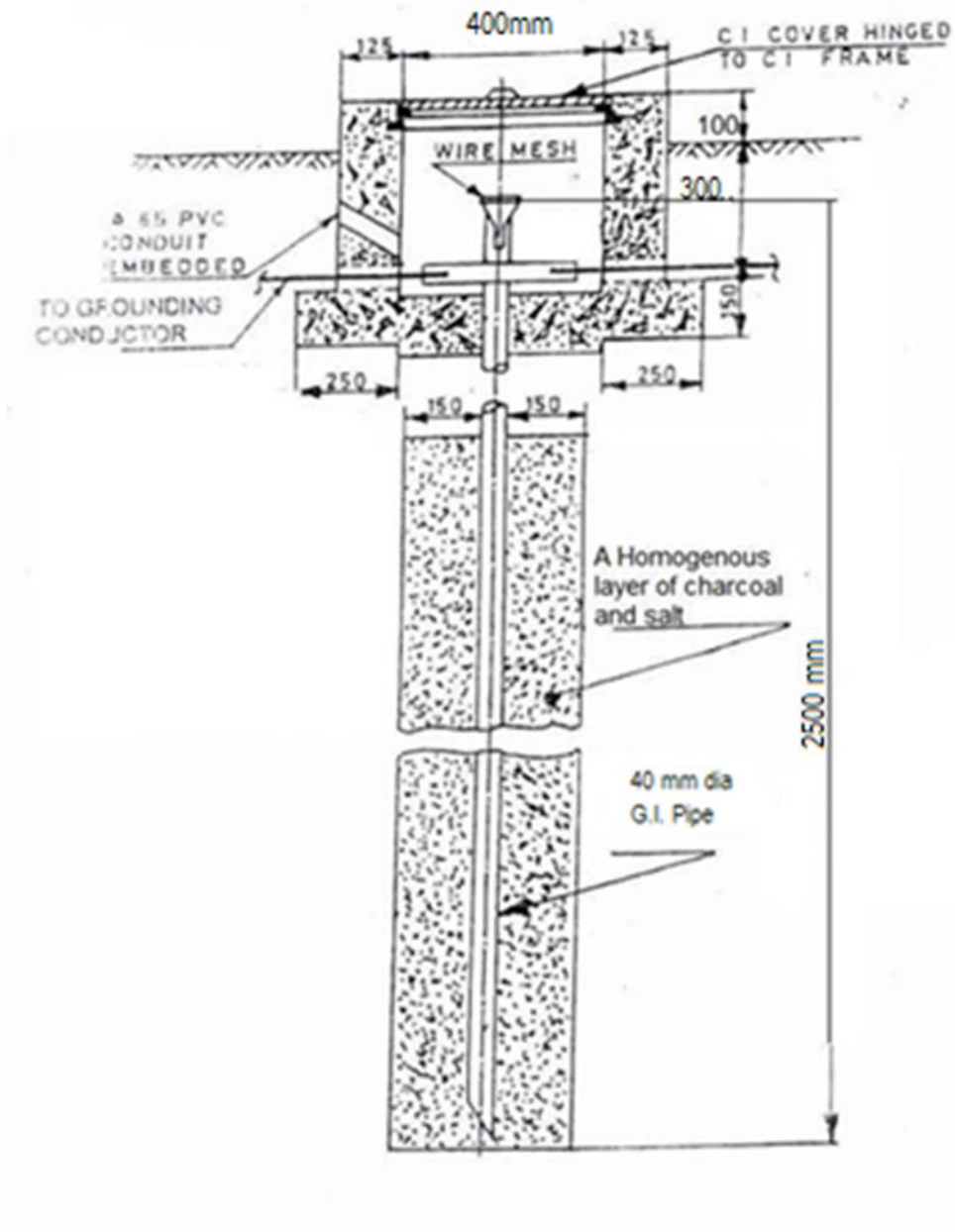

SECTION – 14

LED LIGHTNING, SWITCH & METERING BOX

LED LIGHT FITTINGS AND STREET LIGHT FITTINGS

General requirements of LED Type (INDOOR/OUTDOOR) light fitting.

CEE/SWR specification No: SWR/LED LIGHT FITTING (Indoor/Outdoor) /001-2016

1	LED Make	NICHIA / OSRAM / SEQUIL / PHILIPS LUMILEDS / CREE / LEDNIUM / AVAGO
2	Type of LED	High Power, SMD (Surface Mounting Device) LED
3	Lumen Output/Efficiency	> 100 Lumens / Watt
4	Lumen Output at fitting level/ Efficiency	> 75 Lumens / Watt
5	LED Life	> 50,000 burning hours
6	Depreciation	30% max, after 50,000 burning hours
7	Colour Rendering Index (CRI)	> 75
8	Nominal Voltage	220 V AC
9	Input Operating Voltage	105-295 V AC
10	Power Factor	> 0.9
11	Protections	
	i. Surge protection	1.5 KV for 50 micro seconds
	ii. Over voltage protection	300 V AC for 2 minutes
	iii. High voltage protection	1.72 KV AC for 1 minute
	iv. Insulation Resistance	Minimum 2 mega ohms with 500 V megger
12	Driver Type	Constant Current driver with short circuit protection
13	Driver Components	Industrial grade only
14	THD	< 20%
15	Efficiency of Driver Electronic	Efficiency of driver > 85%
16	Construction of Housing	Pressure die cast aluminium or CRCA or Extruded aluminium
17	Finishing	Power coated / anodized
18	Lamp Cover	Toughened glass of min. 0.8 mm thickness of sufficient strength of high transmittance efficiency (min.90%) Acrylic diffuser as per need of fitting
19	Secondary optics	Polycarbonate reflector / polycarbonate lence
20	Mounting	Indoor: Suitable for Surface / Recessed / Hung Type Outdoor: Suitable for Existing pole etc.,
21	Ingress Protection	IP 20 – Indoor IP 65 – Outdoor.

NOTE:

- Supplied LED Luminaires shall conform to BIS:16107 or IEC 62722 and LEDs to BIS:16103 or IEC: 62717
- LED Luminaires shall also conform to LM- 79 (For quoted fitting) and LM- 80 for LEDs used.
- Firms have to submit LM80& LM79 test certificate from National/International accredited Laboratory and OEM certificate for compliance of BIS/IEC along with offer.
- Firms have to submit warranty certificate for 5 (five) years along with supply
- Make of whole LED Luminaire shall be as per approved make enclosed as annexure

Following information's are to be mentioned by consignee in indent description.

- Type of luminaire: Like Street light, Flood light, focus light, retrofit (for retrofit type luminaire, this specification may be referred wherever applicable)
- Total wattage of LED luminaire
- Arrangement of LED: Single LED/ Multi LED
- Dimensions if required.
- Indoor/ Outdoor
- Mounting type: ie., Indoor: Suitable for Surface / Recessed /Hung Type
- Outdoor: Suitable for Existing Pole etc.

❖ **Sheet Metal/Deep drawn street lighting metering box with Automatic control switch, contactors with single phase 5-30 Amps meter & 50/5A CT**

The Sheet metal street light metering Box should be fabricated with 26 SWG Sheet metal with knock out block for cable entry and exit with metal glands. The box should have sufficient space and Din rail to house the protective equipment (ELCB/MCB), Auto changeover contactor with timer relay along with 3 phase 440 V 5-30 Amps High accuracy Energy meter. The Box door should have waterproofing rubber gasket along with viewing window for taking meter readings. The box should have necessary clamping arrangements for clamping on to the marked Street light pole.

❖ **Automatic Switches for street lights**

The system should consist of an RTC (Real Time Clock) based Electronic timer with an operating voltage of 220 v AC 50 Hz, having necessary NO/NC contacts

- Compact 17.5 mm Wide
- Multi-Function: (8 or 18) Non-Signal & Signal based functions
- Multi-Voltage: 24 – 240 VAC/DC
- Wide Timing Range: 0.1s to 999 Hr
- 3 Digit LCD for Preset time and Runtime
- Option to select Up/Down counting
- Tamper-proof with key lock feature
- Panel mounting only
Made of environmentally friendly materials
AC or DC coil control (conventional or electronic)
Side-mount auxiliary contacts
- Surge suppressors
- IP20 terminal blocks

- Terminal shields
- Terminal covers
- Connecting components
- Terminal lugs
- Mechanical/electrical interlocks

SMC: (Sheet Moulding Compound)

SMC is a hot press molded advanced plastic composites used by EPP engineers to produce SMC meter box, SMC electric junction box and other variety of electrical products. These ranges of products are free from all the issues of rusting, denting, splitting, maintenance, etc. There are certain points for design and construction of SMC meter boxes that EPP experts want you to remember-

- Minimum inside dimensions of the meter box should be suitable for installing distinct meters that users get from the market.
- The meter box is crafted with anti-corrosive, rust proof, dust proof, water proof, UV protected and flame-retardant high-grade material that should have great dielectric and mechanical strength properties.
- The base of the meter box and cover should have at least two similar wire sealing holes for sealing purposes

EPP experts test the meter box as per the IS standards. Each test is performed in the laboratory that is accredited by the standard government bodies to ensure that the meter box meets all the requirements and safety standards.

Various types of testing includes-

- Flammability
- Self extinguishing
- Glow wire test
- Ball pressure test
- Heat deflection temperature
- Water absorption
- Mechanical strength
- Marking, dimension, and built
- UV ageing
- test Light transmission

EPP composites Pvt. Ltd. experts among leading suppliers of SMC electrical products like electric boxes. They have a team of experienced skilled workers that offers reasonable competitive priced products to stand ahead of the competitors.

Having more than thousand of satisfied customers with our workmanship, we ensure good quality products that meet all required standards and customer's specifications.

You can put requests in a mail and send us at our email address directly. To inquire about SMC meter box, navigate to our inquiry page.

SALIENT FEATURES

- Single piece molded without any joints
- Concealed metal hinges
- Mounting screws fitted from inside
- Metal hardware for wire seal
- Adequate space for meter and cutouts
- Wide range for different applications
- Lightweight, yet strong
- Weatherproof
- Prices matching conventional meter boxes
- Shockproof
- Free from pilferage
- Maintenance-free
- Lower thermal conductivity and Good adaptability dimensional stability with UV resistance and Flexibility in design

SECTION-15

MISCELLANEOUS MATERIALS

1. Heavy-duty long barrel copper terminal

The cost includes supply of heavy-duty long barrel copper terminals of different sizes bearing technical specification as mentioned

- i. The terminals should be made of High Purity Copper Tube, and should be annealed.
- ii. It should feature a Double Length Barrel for enhanced Electrical and Mechanical performance in Heavy Duty applications.
- iii. There should be no cracks or gaps (Including inspection hole) to prevent the entry of water or moisture into the crimped joint making these terminals suitable for outdoor applications.
- iv. The terminals should be electrically Tin Plated to prevent atmospheric corrosion.
- v. The make of copper terminal shall be as per list of approved make.

2. 7/10 SWG Guy Wire:

The GI stay wire used for guy set shall conform to the specification indicated and the strain insulator for LT line is No 8 and for HT line No 15 as per detailed specification and drawing furnished shall be used.

3. Mild Steel Black Grade 'B' Bolts & Nuts:

The specification covers manufacture and supply of mild steel hexagonal black grade 'B' bolts and nuts, manufactured from 4.6 / 4.8 grade material as per ISS 1363 and its latest revisions thereof.

The bolts and nuts shall be free from dirt, dust and burns, cleanly finished, so that it shall be possible to turn the nuts freely with hand, but the ply shall be minimum. The bolts length less than 65mm shall be fully threaded & above 65mm must be threaded to the extent specified in IS:1363 and its latest revisions thereof. Tests shall be carried out in accordance with the relevant clauses of IS 1363 and test certificates thereon shall be submitted to this office and dispatches shall not be made till these test certificates are approved. The bolts and nuts shall be supplied duly packed in heavy new gunny bags and the weight of the individual bag shall not exceed 50 Kgs.

SECTION -16

CONCRETE

Technical Specification for Concrete:

The detailed cement concrete specification give information about quality and the quantity of the materials, proportion of mortar, workmanship, method of preparation and execution of work etc. The cement concrete specification is properly prepared which makes it easy on site for execution of cement concrete work.

Coarse Aggregates:

Coarse aggregate shall be of broken stones of granite or similar stones. They shall be free from dust, dirt and other foreign matters. Size of the stones should be 20 mm and down all should be retained on 5 mm square mesh and well graded such that it should not have voids more than 42 %.

Fine Aggregates:

Fine aggregates shall be of coarse sand and should have hard, sharp and angular grains. The grains should pass the screen of 5 mm square mesh. The sand should be of standard specification and should be free from dust, silt and it should not be obtained from sea.

Cement:

Cement used for the construction should be fresh and it should not be too old. It should be of good quality and should meet all the standard specifications. The minimum compressive strength of cement should be 175 kg/ m².

Water:

Water should be clean and free from alkaline and other acidic matter. It should be suitable for drinking purpose.

Proportion:

M7.5:

The proportion of the cement concrete should be **1:4:8** or as prescribed. For the proportion of 1:4:8 the quantity of materials goes as one part of cement, four parts of sand and eight parts of aggregates.

M10:

The proportion of the cement concrete should be **1:3:6** or as prescribed. For the proportion of 1:3:6 the quantity of materials goes as one part of cement, three parts of sand and six parts of aggregates.

M15:

The proportion of the cement concrete should be **1:2:4** or as prescribed. For the proportion of 1:2:4 the quantity of materials goes as one part of cement, two parts of sand and four parts of aggregates.

M20:

The proportion of the cement concrete should be **1:1.5:3** or as prescribed. For the proportion of 1:1.5:3 the quantity of materials goes as one part of cement, one and half parts of sand and three parts of aggregates.

Grade of Concrete	Mix of (Cement:Sand:Aggregate)	Size of Coarse Aggregates
M20	1:1.5:3	20 mm
M15	1:2:4	12.5 mm, 20 mm, 40 mm
M10	1:3:6	20 mm, 40 mm, 60 mm
M7.5	1:4:8	40 mm, 63 mm
M5	1:5:10	40 mm, 63 mm
Low Grade	1:6:12	40 mm, 63 mm

Mixing:**Hand Mixing:**

Hand mixing is done on masonry platform or iron sheet tray. For the proportion of 1:2:4 first of all 2 boxes of sand and one bag of cement shall be properly and thoroughly mixed. Then 4 boxes of aggregates are added into the mix and then it is again properly mixed. The mixture should be dry mixed till all the materials are mixed together. Water is then added gradually along with turnings of the mixture. Generally 25-30 liters of water per bag of cement is used to obtain plastic mix of required workability and water cement ratio.

Machine Mixing:

In machine mixing for the proportion of 1:2:4 first of all 2 boxes of sand are dumped into the cement concrete mixer then one bag of cement and four boxes of aggregates are gradually added and rotated for dry mix to obtain required colour and then required quantity of water is added by water can. While being mixed, generally 25-30 lit of water per bag of cement is used to obtain required workability and water cement ratio.

Curing:

When the concrete gets hardened (generally after 3-5 hours of laying) wet gunny bags are placed on the concrete surface to keep the surface damp till 24 hours. The next day onward the concrete surface is flooded with water for 15 days for proper curing.

SECTION-8C

EXPLANATORY NOTES

Explanatory notes of Schedule A & B for the work of “SHIFTING OF ELECTRICAL UTILITIES INFRINGING PROPOSED CORRIDOR-2 OF BENGALURU SUBURBAN RAIL PROJECT BETWEEN LOTTEGOLAHALLI – YESWANTPUR OF BAW-BAPL SECTION”.

Supply, Testing & laying of **11 kV, 3 Core, HTUG Cable**, for insulations High quality clean XLPE compound shall be used (Free from micro voids, Moisture content, ambers and contaminations) with pressure extruded, inner sheath round wire armored as per IS-7098 (Part-2) Armoring wires dia in average $\pm 2.5\%$ and Resistivity 14 Ohms/KM (Max) as per IS-3975. As per the scope of work the size of the cable shall be 3x400, 3x240 & 3x95 sq.mm sq.mm cables shall be supplied and laid. The detailed specification of cable has been discussed in section 8-B under technical specification. The scope of work also includes manual digging of cable trench or by drilling 5’6”/8” bore by HDD method and laying of cable along suitable size HDPE pipe as per site requirement, supply and laying of 2000mm length, 150 mm Dia RCC pipe, RCC collar, supply of cable route and cable joint indicating stones, drawing of cable in the trench, reconsolidation of trench and making good the road up to the satisfaction of BBMP or other civic bodies/agencies, if any. In case of normal cable trench is required to be Dugged, excavation of cable trench of 450mm wide and 1000mm deep in all kinds of soil and refilling the cable trench with 150mm beddings of river sand above and below the cable including protection by laying country bricks across the trench, excavated soil free from unwanted materials, ramming, consolidating and bringing to its original finish.

In case trench is excavated on either side of track, the LT UG cable has to be laid in all kinds of soil in a trench of 1.0 mtr. depth with river sand cushioning for laying of cable throughout the length of trench. Stock Bricks should be laid breadthwise without any gap on the top of the cable in the trench to ensure protection. The excavated soil to be filled back. All other items which are required for satisfactory completion of work are to be borne by the contractor. After laying of cable in the trench, the filled-up soil has to be rammed and the trench has to be brought back to shape in conjunction with the surroundings.

In case cable is to be laid underneath the track/road, the cables shall be drawn through HDPE/RCC hume pipes. Trench to accommodate pipe shall be of suitable width and excavated at 1.0 mtr. below the formation level. No sand cushioning and spreading of bricks are required. But once the pipes are laid in the trench, it should be made to its original formation level by filling it up with excavated earth by watering and ramming process and resetting the ballast of track to its original level. Similarly, when road has been dug for laying of the cable the same should be re-filled, rammed and asphalted and brought to original condition. The cable rising above ground shall be taken through GI pipe neatly clamped and open end of GI pipe has to be sealed with bitumen compound. The cable has to be laid along the route as per instruction of Engineer. The laying of cables includes uncoiling of cable from cable drum, laying of the cable in the trench free from twists, bends, peeling of insulation, dressing at terminal ends, provision of cable glands, crimping with suitable shoe, connection at both ends & earthing of armor at both ends.

The cost of work includes depositing earth on bank up to a lead of 50 mtr., supplying and fixing of necessary danger boards/cable route indicators at every 100 mtrs. Etc. The cost of work includes the associated works involved in satisfactory completion of HT UG cable laying work.

The cable laying method shall comply with IS:1255 (1983). The cost of work also includes the associated works involved in satisfactory completion of cable supply and laying.

Compact Sub Station-800KVA Cu. Wound,500KVA AL. Wound

Supply, installation, testing & commissioning of compact pre - fabricated packaged sub - Station (as per IEC-60694/IS-3427) of 11kV/433V consisting of 3-way SF6/VCB insulated compact RMU, oil cooled CRGO/Amorphous Core Star - 2 Rated (5 Star) Transformer and LT section with one MCCB/ACB as incoming and following outgoing MCCB feeders and with enclosure made of electronically Galvanized steel sheet (min 2 mm Thickness) with powder coated finish, Cu bus bar with LT Metering facility of different capacity. Explanatory note for the different capacity of CSS is as follows:

- i. Supply, installation, testing & commissioning of compact pre - fabricated packaged sub - Station of capacity 500 kVA Aluminum wound transformer, 800 Amps ACB 50 kA 4 pole fixed type micro processor based for LT incomer and 7 Nos 250 Amps MCCB 4 pole 36 kA TM based for outgoing. The detailed specification of Compact substation has been discussed in section 8-B under technical specification. Lettering the RMU with enamel paint and also writing single line diagram on each panel, fixing of caution board, danger board etc. The cost of work includes the cost of Labour, paint, brush etc. for satisfactory completion of work. Fixing foundation frame of channels and angle iron welding, fixing in concrete, aligning the CSS on foundation bed, assembly of units, connecting bus bars from panel to panel, initial filling of oil etc., and commissioning of Compact substation. The cost of work includes the Labour and items required for satisfactory completion of foundation work, lifting of excess earth and excavation of foundation for Compact substation. The cost of work includes the cost of associated work for satisfactory completion of supply, testing and commissioning of compact substation.
- ii. Supply, installation, testing & commissioning of compact pre - fabricated packaged sub - Station of capacity 800 kVA Copper wound transformer, 1250 Amps ACB 50 kA 4 pole fixed type micro processor based for LT incomer 250 Amps MCCB -6 no's 4pole 36 kA TM based for outgoing. The detailed specification of Compact substation has been discussed in section 8-B under technical specification. Lettering the RMU with enamel paint and also writing single line diagram on each panel, fixing caution board, danger board etc. The cost of work includes the cost of Labour, paint, brush etc. for satisfactory completion of work. Fixing foundation frame of channels and angle iron welding, fixing in concrete, aligning the RMU on foundation bed, assembly of units, connecting bus bars from panel to panel, initial filling of oil etc., and commissioning of RMU. The cost of work includes the cost of associated work for satisfactory completion of supply, testing and commissioning of compact substation.

Compact RMU

Supply, installation, testing & commissioning of **Compact RMU** (VCB/SF6 Type) with Copper Busbar, 350 MVA, 630 Amps as per IEC-62271/IS-3427, 3-way RMU (**2 OD+1 VL**) consisting of one incomer, one breaker, one outgoing with Al. Busbar. The scope of work involves Earth excavation for RMU foundation, depositing of earth bank up to a lead of 50mtr and with a lift up to 1.5mtr, Bed concreting with CC 1:2:4, foundation with reinforcement CC 1:2:4, providing plinth with CC 1:2:4 on the stone masonry (if required), Construction of stone masonry (if required). The scope also includes supply of MS Channel (100x50mm) & MS Angle (40x40x5mm) with welding etc. complete, providing of Rod type earthing with 40mm dia, 2.5 mtr long MS rod as

per specification & drawing enclosed. The scope of work also includes aligning the RMU on foundation bed, assembling of units, connecting bus bars from panel to panel, initial filling of oil, lettering the RMU with enamel paint and also writing single line diagram of each panel, caution board, danger board etc., and commissioning of RMU. The cost of work includes the Labour and other associated items required for satisfactory supply, testing and commissioning of above work.

Supply, installation, testing & commissioning of **DAS compact RMU (VCB/SF6 Type)** as per IEC-62271. The DAS RMUs shall have the following in addition to the Standards:

- DC motors, Numerical Relays, Multi-functional meters, fault passage indicator (FPI), Metering CTs, Protection CTs, Auxiliary transformers, Potential transformer, Batteries, Battery chargers (12 V & 24 V), AC power socket and light for illumination of Control panel.
- Control cable from each panel shall be wired and terminated to suitable 24 pin connector in the control panel.
- Suitable space for fixing the Remote Terminal Unit (RTU) and Radio Modem in Control panel.
- Suitable Clamps for fixing Antenna Pipe

Supply, installation, testing and commissioning of **5-way RMU (20D+3VL):**

The 5-way RMU (2 OD+3VL) which is consisting of one incomer three breakers and one outgoing with DAS specification as discussed in section 8B under technical specification. The scope of work involves Earth excavation for RMU foundation, depositing of earth bank up to a lead of 50mtr and with a lift up to 1.5mtr, Bed concreting with CC 1:2:4, Foundation with reinforcement CC 1:2:4, providing plinth with CC 1:2:4 on the stone masonry (if required), Construction of stone masonry (if required). The scope also includes supply of MS Channel (100x50mm) & MS Angle (40x40x5mm) with welding etc., complete, providing of Rod type earthing with 40mm dia, 2.5 mtr long MS rod as per specification & drawing enclosed. The scope of work also includes aligning the RMU on foundation bed, assembling of units, connecting bus bars from panel to panel, initial filling of oil, lettering the RMU with enamel paint and also writing single line diagram of each panel, caution board, danger board etc., and commissioning of RMU. The cost of work includes the Labour and other associated items required for satisfactory supply, testing and commissioning of above work.

Termination Kit's

1. Supply and making cable end termination by **Heat Shrinkable Indoor & Outdoor type** cable termination kit for 11 kV XLPE cables. The size of cable end termination shall be 3X400, 3x240 & 3x95 Sq.mm. The specification of end termination kit has been discussed in section 8-B under technical specification. The cable termination method shall comply with IS:1255 (1983). The cost of work also includes cost cable lugs and other associated works etc. for satisfactory completion of cable end termination.
2. Supply and making straight through joints of **heat shrinkable straight through jointing kit** for 11 kV XLPE Cable with Copper Lug of the following sizes. 3X400, 3x240 & 3x95 Sq.mm for 11 KV HT UG XLPE cable. The specification of straight through joint kit has been discussed in section 8-B under technical specification. The cable termination method shall comply with IS:1255 (1983). The cost of work also includes cost cable lugs and other associated works etc. for satisfactory completion of cable end termination.
3. Supply, Installation, Testing & Commissioning of 1.1 kV, XLPE or heat resistant PVC insulated, PVC extruded inner sheath armored **LT UG Cable** as per IS-1554 (Part-1) or IS-7098 Part-1, armoring strip thickness as per IS-3975. The size of the cable shall be 240 sq.mm 3.5 core, 95 sq.mm 3.5 core, 50 sq.mm 4 core, 16 sq.mm 4core. The scope of work also includes manual digging of cable trench or by drilling 5'/6"/8" bore by HDD method and laying of cable along suitable size HDPE/PLB pipe as per site requirement, laying of cable trench/GI pipe/stone ware/RCC Hume pipe using wooden/ Aluminum rollers as directed by site Engineer. In case of normal cable trench is required to be Dug, excavation of cable trench of 450mm wide and 1000mm deep in all kinds of soil and refilling the cable trench with 150mm beddings of river sand above and below the cable including protection by laying country bricks across the trench, excavated soil free from unwanted materials, ramming, consolidating and bringing to its original finish.

In case trench is excavated on either side of track, the LT UG cable has to be laid in all kinds of soil in a trench of 1.0 mtr. depth with river sand cushioning for laying of cable throughout the length of trench. Stock Bricks should be laid breadthwise without any gap on the top of the cable in the trench to ensure protection. The excavated soil to be filled back. All other items which are required for satisfactory completion of work is to be borne by the contractor. After laying of cable in the trench, the filled-up soil has to be rammed and the trench has to be brought back to shape in conjunction with the surroundings.

In case cable is to be laid underneath the track/road, the cables shall be drawn be drawn through HDPE/RCC hume pipes. Trench to accommodate pipe shall be of suitable width and excavated at 1.0 mtr. below the formation level. No sand cushioning and spreading of bricks are required. But once the pipes are laid in the trench, it should be made to its original formation level by filling it up with excavated earth by watering and ramming process and resetting the ballast of track to its original level. Similarly, when road has been dug for laying of the cable the same should be re-filled, rammed and asphalted and brought to original condition. The cable rising above ground shall be taken through GI pipe neatly clamped and open end of GI pipe has to be sealed with bitumen compound. The cable has to be laid along the route as per instruction of Engineer. The laying of cables includes uncoiling of cable from cable drum, laying of the cable in the trench free from twists, bends, peeling of insulation, dressing at terminal ends, provision of cable glands, crimping with suitable shoe, connection at both ends & earthing of armour at both ends.

The cost of work includes depositing earth on bank up to a lead of 50 mtr., supplying and fixing of necessary danger boards/cable route indicators at every 100 mtrs. Etc. The cost of work includes the associated works involved in satisfactory completion of LT UG cable laying work.

4. Supply and stringing of 1.1 kV, 3*95+1*70+1*16 sq.mm, **LT Aerial Bunched Cable**, confirming to IS-14255: 1995 XLPE insulation. The scope of work includes supply and fixing of accessories for AB Cables as per NF-33, as per IS-13573 for joints & terminations such as suspension clamp for insulated messenger wire of size 25 to 95 sq.mm, dead end clamp/anchor clamp assembly 70 to 210 sq.mm bare messenger, dead end clamp/anchor clamp assembly 25 to 95 sq.mm bare messenger, piercing connector suitable for 16 sq.mm to 95 sq.mm AB Cable – Service connection, piercing connector suitable for 16 sq.mm to 95 sq.mm AB Cable – main to main connection, pre-insulated lugs CPTAU for 95 sq.mm, piercing connector suitable for 16 sq.mm to 95 sq.mm AB Cable – Street light connection, three phase distribution box for 6 connections, end cap for 50/70 sq.mm, universal hook, bolts & nuts etc., The cost of work includes labour & items required for satisfactory completion of work.
5. Supply & making of earthing arrangements. The scope of work includes digging of pit for providing pipe type earthing, installation of G.I grounding pipe of class-B, 40mm dia, 2.5 mtr long, 3.2mm thick with bolts, nuts, G.I strips & washer. The pit should be filled with equal proportion of salt & charcoal 150 mm all-round the pipe to complete depth. The scope of work also includes construction of earth chamber as per IS:3043, supply and fixing earth chamber door, measuring earth value and inscribing the same on earth chamber. The specification of earthing has been discussed in section-8-B under technical specification.
6. **Providing and laying in position plain cement concrete of mix M-7.5 (1:4:8):** Providing of M-7.5 cement concrete with OPC cement @ 180 Kgs, with 40mm and down size graded granite metal coarse aggregates @ 0.85 cum and fine aggregates @ 0.57 cum, machine mixed, concrete laid in layers not exceeding 15 cms. thick well compacted in foundation and plinth, including cost of all materials, labour, cost of HOM of machinery, curing etc. required for satisfactory completion of work. The specification of M-7.5 concrete has been discussed in section-8-B under technical specification.

Providing and laying in position plain cement concrete of mix M15 (1:2:4): Providing M-15 cement concrete with cement @ 240 Kgs, with 20 mm and down size graded granite metal coarse aggregates 0.878 cum and fine aggregates 0.459 cum, machine mixed concrete laid in layers not exceeding 15 cms. thick well compacted, in foundation and plinth and cills, including cost of all materials, Labour, HOM of machinery, curing complete as per specification as given in section8-B of Technical specification. The cost of work includes the Labour and other items required for satisfactory completion of above work.

Providing and constructing of granite/trap/ballast size stone masonry in foundation cement mortar 1:8 stones hammered and dressed in courses not less than 20 Cms. Height, bond stones at 2 mtr. apart in each course. The cost of the work includes cost of materials and Labour required for satisfactory completion of work.

Plastering concrete surface in cement mortar 1:4 and 20mm thick inclusive of smooth rendering of curing etc. complete above ground level. The cost of work includes the cost of labour and other items required for satisfactory completion of work.

7. Supply, Installation, Testing & Commissioning of **L.T. Feeder pillar box** with porcelain rewirable cutout and 1 No. of 630A load break switch with copper bus bar as per IS-13947 Part-1&2,

12-way
8-way

The scope also includes Mounting of LT feeder pillar box including necessary civil works like soil excavation, supply and constructing of burnt brick masonry with approved non-modular bricks of standard size of class designation of 5.0 newton/sq.mm (table moulded) with cement mortar 1:8 for basement and super structure including cost of material, scaffolding, curing, plastering concrete surface in cement mortar 1:4 and 20mm thick inclusive of smooth rendering of curing etc. complete above ground level. The cost of work includes the Labour and other items required for satisfactory completion of supply and installation of LT feeder pillar. The detailed specification of LT feeder pillar has been discussed under section8-B under technical specification.

8. Supply and laying of 2000mm long, 150mm dia **RCC Hume pipe** for crossing the cable in the existing road. The scope also includes digging of earth for required depth to provide RCC Hume pipe and cable collar, re-consolidation of the soil. The location of the work will be as indicated by site Engineer. The re-consolidation work shall be done up to the satisfaction of BBMP/any civic body. The cost of the work includes satisfactory completion of the work in all respect.
9. Supply and laying/erection of **GI pipe of class B**, 150mm dia for raising of cable at transformer centers/DP structures/Drainages etc. The cost of work includes digging of soil to suitable length to raise the UG cables and reconsolidation of earth. The cost of work includes supply and fixing of clamps, bolts, nuts & washers for fixing GI pipe on RCC/PSCC poles, RCC clamp etc. for satisfactory completion of supply and erection GI pipe.
10. Supply and erection of Pre-stressed **Tubular spun pole** of 11mtr long, 500kg Working load (drawing No. BESCO/GM/QS&S/45 dtd 09/02/2022) as per IS-13158:1991. The scope of work involves earth excavation for Spun pole foundation, Base concreting with CC 1:4:8 of dimensions (1000x1000x150mm), Pole concreting with CC 1:2:4 of dimensions (1000x1000x2500mm), Coping with CC 1:2:4 (as per actuals) 390mm all around the pole for a height of 300mm, installation of single pole transformer structure kit with three H frames without transformer seating and seating angle support cross arm for 63/100/250/500 KVA (UG Cable)-GI, installation of HT Single top support with bolts, nuts & washers, supply and installation of 11 KV, 5KN Polymeric pin insulator (24mm dia FRP rod), supply and fixing of Rabbit conductor for jumps, GI wire 10SWG, Guy wire 7/10 SWG, fixing of G.I pipe 100 mm dia, installation of Distribution transformer BEE-5 star rated of appropriate capacity with oil, fixing of 11KV solid core type H.G fuse unit, fixing of 11 KV 200A single break / 400A Double break G.O.S, providing earthing materials, Installation of LT Distribution box for suitable rating with MCCB including wiring with all necessary works related to wiring, installation of Lightning arrestor, cross arm supports with necessary fish plates, bolts & nuts, installation of anticlimbing device, caution / danger board etc., complete. The cost of work involves for satisfactory completion of supply and erection of above work. The specification of spun pole has been discussed in section-8-B under technical specification. Supply and fixing different types of SPMT is explained below:
- i. The scope of work involves earth excavation for Spun pole foundation, Base concreting with CC 1:4:8 of dimensions (1000x1000x150mm), Pole concreting

with CC 1:2:4 of dimensions (1000x1000x2500mm), Coping with CC 1:2:4 (as per actuals) 390mm all around the pole for a height of 300mm, Installation of Three H frame with transformer seating and seating angle support cross arm for 11mtr spun pole for 25KVA (UG cable)-MS, Installation of HT Single top support with bolts, nuts & washers, Installation of 11 KV, 5KN Polymeric pin insulator (24mm dia FRP rod), Rabbit conductor for jumps, GI wire 10SWG, Guy wire 7/10 SWG, G.I pipe 100 mm dia, installation of Distribution transformer BEE-5 star rated of appropriate capacity with oil, 11KV solid core type H.G fuse unit, 11 KV 200A single break / 400A Double break G.O.S, providing earthing materials, Installation of LT Distribution box for suitable rating with MCCB including wiring with all necessary works related to wiring, Installation of Lightning arrestor, cross arm supports with necessary fish plates, bolts & nuts, installation of anticlimbing device, caution / danger board etc., complete. The cost of work involves for satisfactory completion of supply and erection of above work.

- ii. The scope of work involves earth excavation for Spun pole foundation, Base concreting with CC 1:4:8 of dimensions (1000x1000x150mm), Pole concreting with CC 1:2:4 of dimensions (1000x1000x2500mm), Coping with CC 1:2:4 (as per actuals) 390mm all around the pole for a height of 300mm, installation of single pole transformer structure kit with three H frames without transformer seating and seating angle support cross arm for 63/100/250/500 KVA (UG Cable)-MS, Installation of HT Single top support with bolts, nuts & washers, Installation of 11 KV, 5KN Polymeric pin insulator (24mm dia FRP rod), Rabbit conductor for jumps, GI wire 10SWG, Guy wire 7/10 SWG, G.I pipe 100 mm dia, installation of Distribution transformer BEE-5 star rated of appropriate capacity with oil, 11KV solid core type H.G fuse unit, 11 KV 200A single break / 400A Double break G.O.S, providing earthing materials, Installation of LT Distribution box for suitable rating with MCCB including wiring with all necessary works related to wiring, Installation of Lightning arrestor, cross arm supports with necessary fish plates, bolts & nuts, Installation of anticlimbing device, caution / danger board etc., complete. The cost of work involves for satisfactory completion of supply and erection of above work.

11. Supply and erection of 9mtr long RCC/PSCC pole, square section

i. Supply, erection of 9 mtr. long 300 kg working load RCC/PSCC pole (as per drawing No.(BESCOM/GM/QS&S/55 dtd 23/12/2019) as IS-785 : The scope of work involves supply, erection and installation of RCC/PSCC pole of 9mtr long, 145 Kg working load, Installation of 11 KV Horizontal cross arm with clamps, HTST supports, bolts, nuts & washers for RCC/PSCC poles, RCC clamp, Guy set complete with 8/15 strain insulator and associated concrete, 11kv,5KN polymeric insulator (where ever necessary), 11kv,5KN polymeric insulator (24 mm dia FRP rod), PG clamps for rabbit conductor etc. The scope of work also involves earth excavation with required size for RCC/PSCC pole foundation, base concreting with CC 1:4:8 of dimensions (500x650x150mm), Pole concreting with CC 1:2:4 of dimensions (650x500x1700), coping with CC 1:2:4 (as per actuals) 150mm all around the pole for a height of 300mm, guy concerting with boulders, mud and sand, Installation of anticlimbing device, Caution/Danger boards etc., complete. The cost of work involves for satisfactory completion of supply and erection of above work. The specification of pole has been discussed in section-8-B under technical specification.

ii. Supply, erection of 9 mtr. long 150 kg working load RCC/PSCC pole (as per drawing No.(BESCOM/GM/QS&S/51 dtd 24/11/2018) as IS-785: The scope of work involves supply, erection and installation of RCC square section of 9mtr long, 150 Kg working load, Installation of 11 KV Horizontal cross arm with clamps, HTST supports, bolts, nuts & washers for RCC/PSCC poles, RCC clamp, Guy set complete with 8/15

strain insulator and associated concrete, 11kv,5KN polymeric insulator (where ever necessary), 11kv,5KN polymeric insulator (24 mm dia FRP rod), PG clamps for rabbit conductor. The scope of work also involves earth excavation for RCC/PSCC pole foundation, Base concreting with CC 1:4:8 of dimensions (650x650x150mm), Pole concreting with CC 1:2:4 of dimensions (650x650x1700), coping with CC 1:2:4 (as per actuals), guy concerting with boulders, mud and sand, Installation of anticlimbing device, Caution/Danger boards etc., complete. The cost of work involves for satisfactory completion of supply and erection of above work. The specification of pole has been discussed in section-8-B under technical specification.

- 12.** Releasing and handing over BESCO's asset: The following below mentioned items are required to be released during the course of work and as per site requirement and shall be handed over to the concerned BESCO stores at no extra cost of KRIDE. The scope of the work also includes proper account of released item:
- i. Releasing of 9 mtr long RCC pole of square section- 106 no's.
 - ii. Releasing of 11 Kv cross arms, with pole, clamps, bolts & nuts.
 - iii. Releasing of coyote wire.
 - iv. Releasing of rabbit ACSR Conductor per wire/km.-6.3 km
 - v. Releasing of 500 Kva DTC from TC set. - 2 no's
 - vi. Releasing of 250 Kva DTC from TC set. - 7 no's
 - vii. Releasing of 100 Kva DTC from TC set. - 1 no's
 - viii. Releasing of DP Structure complete including pole.
 - ix. Releasing of PSC Pole as per direction of Engineer-in-Charge of work.
 - x. Releasing of 11 KV solid core type HG fuse unit.
 - xi. Releasing of 11 KV, 200 Amps, Single break G.O.S.-48no's.
 - xii. Releasing of LT Distribution Box for 250 kVA with MCCB and LT Wiring (From DTC to LT Line via Metering Box & LT Protection Kit) DOUBLE CIRCUIT- 11no's
 - xiii. Releasing of 11mt long Spun pole- 16 nos
 - xiv. Releasing of Spun pole structure kit.-6 no's.
 - xv. Releasing of LT Metering box for housing ETV Meter without CT's.-11 no's.
 - xvi. Releasing of Distribution Transformer 500 KVA, 250 kVA, 3Ph, 11KV/433V, 50Hz, with Oil.
 - xvii. Releasing of HG Fuse Unit-11 no's.
- 13.** The following items are required to be released and re-erected during the course of work. The location will be advised by the site engineer during the course of work.
- i. Releasing and re-erection of LT Distribution Box for 250 kVA with MCCB and making LT Wiring (From DTC to LT Line via Metering Box & LT Protection Kit) DOUBLE CIRCUIT
 - ii. Releasing and re-erection of LT Metering box with CTs and necessary wiring for housing ETV Meter.
 - iii. Releasing and re-erection of LT Electronic Tri-Vector Meter 5 Amps, -0.5/1.0 Accuracy Class.
 - iv. Releasing and re-erection of 11KV lightning arrestor, metal oxide 9 kV, 5 kA Polymeric Type with Ground disconnector.
 - v. Releasing and re-stringing of 11KV grade aerial bunched 3 core cable of XLPE insulation & black LDPE sheathing having a standard aluminum conductor, standard around a weather resistant black XLPE insulated AAA messenger wire 11KV size 3X95 sq.mm +1X70 sq.mm with bare messenger.

- vi. Releasing and re erection of 11 KV/433V, 250KVA, 3 Phase, 50 Cys Distribution Transformer BEE 4 star rated with oil Re erection of 11 KV/433V, 250KVA, 3 Phase, 50 Cys Distribution Transformer BEE 4 star rated with oil.

Note:

RESPONSIBILITIES OF CONTRACTOR

- 1 The Contractor shall liaison with ESCOM/ KPTCL/ PGCL/GAIL, State/Central Government and local bodies till completion of works in all respect. It is the responsibility of the contractor to ensure proper liaison and co-ordination with State Authorities for availing intimation, payment of Supervision charges and obtaining work orders, line clearance, joint inspection, testing & commissioning energization of in to the full satisfaction of State Authorities and handing over, and KRIDE intervention should not be sought for any of the above.

- 2 **ROW issues if any shall be sorted out by the contractor.**
 - 2.1 It is the responsibility of the Successful contractor to liaison with EB authorities for arranging joint inspections along with KRIDE supervisor as and when required and to ensure for early preparation of estimations, obtaining approvals at various stages, getting sanctioning of estimations and supervision charges intimations (Modification work of HT/LT power line crossings, Additional load/ Availing new power supply for railway installations)

 - 2.2 In connection with the work Contractors has to liaison with EB authorities / statutory authorities in getting the intimations towards the payment of the following and submit the same to this office in time to facilitate for processing the payment by Railway.
 - a. Availing of new supply/service connection charges/deposit.
 - b. Supervision charges (10% of estimate or latest as per EB guidelines) based on sanctioned estimate of ESCOM / KPTCL / PGCL authorities along with copy of sanctioned estimate.
 - c. The contractor shall coordinate for payment of "Supervision Charges" to electricity authority and other charges payable to individual Govt. agencies as per the prevailing government rules, such payment shall be paid by KRIDE.

 - 2.3 KRIDE will pay necessary statutory Charges, related ROW charges, Electrical inspectorate and inspection charges payable to ESCOM. Charges of stamp duties /agreements, TAQC/ MR charges as applicable and any other incidental charges payable to ESCOM / KPTCL/ PGCL / BBMP, GAIL, BWSSB, BDA, to be borne by contractor.

 - 2.4 Execution of agreement with KRIDE / Railways and SEB authorities/ DISCOM submitting Relevant documents for EIG approval as per the requirement. It is the responsibility of the contractor for proper handing over of released materials to State Authorities. For this purpose, it is suggested that a joint inspection with the State

Authorities officials concerned shall be carried out, the items and quantities of materials to be released are assessed properly before the work is started.

K-RIDE

SECTION – 9

BILL OF QUANTITIES (BOQ)

BILL OF QUANTITES (BOQ)

Tender No: KRIDE/BSRP/16/2023

“SHIFTING OF ELECTRICAL UTILITIES INFRINGING PROPOSED CORRIDOR-2 OF BENGALURU SUBURBAN RAIL PROJECT BETWEEN LOTTEGOLLAHALLI – YESWANTPUR OF CHIKKBANAVARA-BAIYYAPPANAHALLI SECTION”.

PREAMBLE

1. The Price Schedule shall be read in conjunction with the Instructions to Tenderers, Conditions of Contract, Notice Inviting Tender, Technical Specifications, Tender Drawings, Schedule, Annexures and Addendums.
2. The tenderer shall quote the single Percentage/Amount over the overall price schedule Above/ At Par/ Below on Karnataka E-procurement portal (i.e., A. Supply of Electrical items associated with shifting/modification of electrical utilities infringing to Corridor-2 i.e., LOTTEGOLLAHALLI – YESWANTPUR OF BAW-BYPL SECTION”. B. Labour charges associated with shifting/modification of electrical utilities of Corridor-2 i.e., LOTTEGOLLAHALLI – YESWANTPUR OF BAW-BYPL SECTION”
 - i. The quoted Percentage/Amount are for completed and finished items of work and complete in all respects. It will be deemed to have included all constructional plant, tools, machinery, labour, supervision, materials, fuel, oil, consumables, electric power, water, transportation, all leads and lifts, dewatering, all temporary works, construction of temporary stores and buildings, fencing, watering, lighting, erection maintenance, night working, inspection facilities, safety measures at work sites for workmen and road users, availing intimation of supervision charges etc, work orders, charges of liaison with ESCOM / KPTCL / PGCL, state / Central Government and local bodies, availing clearance, joint inspection, testing, commissioning and energization, all the other incidental charges payable to ESCOM / KPTCL/ PGCL / BBMP, GAIL, BWSSB, BDA, charges for stamp duties/ agreements, execution of agreement with KRIDE / Railways and SEB authorities/ DISCOM submitting Relevant documents for EIG approval as per the requirement etc., Establishment and overhead charges, labour camps, insurance costs for labour and works, contractor’s profit, all taxes, royalties, duties, cess, octroi, GST other levies and other charges together with all general risks, liabilities and obligations set out or implied in the contract and including remedy of any defects during the Defect Liability Period, unless otherwise provided in Price schedule. However, statutory supervision charges of 10% payable to State Authorities/DISCOM and charges related ROW charges, Electrical inspectorate and inspection charges payable to ESCOM will be paid by KRIDE.
3. Providing concrete for all works deemed to be inclusive of the cost towards production of concrete by batching plant, transit mixer, transportation of concrete with all leads and lifts, form work, shuttering including staging as required, pouring of concrete by pump/tower crane to all heights /depths, tremie or other approved means, compaction by vibrators, curing by approved means such as water, steam or curing compound and all labour, tools, plants, machinery required for execution of work complete in all respects including de-shuttering after completion of work.

4. The whole cost of complying with the provisions of the Contract shall be deemed to have been included in the quoted Percentage/Amount.
5. General directions and description of works and materials are not necessarily repeated or summarized in the Price Schedule.
6. The method of measurement of completed work for payment shall be in accordance with the requirements as stated in the individual sections of the Technical Specifications and Conditions of Contract.
7. Shuttering required for concrete work shall be of steel except wherever there are site constraints as decided by Engineer.
8. Tenderer may please note that to perform this contract, nothing extra shall be payable on account of field constraints, availability of front, preparation of detailed scheme for taking necessary clearance and approval from the concerned authority and other local bodies etc.
9. Contract prices shall be inclusive of all taxes and duties payable by them. Income tax and any other statutory taxes to be deducted at source, if any, will be deducted by the Employer in accordance with Income Tax Act and any other acts in force in accordance with instructions issued by authorities on this behalf, from time to time.
10. The Tenderer is required to furnish the PAN for all members of Group.
11. Replace CA audit with Statutory Auditor wherever applicable, except in qualification of experts.

Note:

1. The Tenderer are advice to quote in percentage rate in two decimals.
2. If no percentage rate has been indicated for any particular schedule/bill in words, as well as in figures, irrespective of the fact whether the Tenderer has written or not written above/below/at par, in such cases, the rate shall be considered as Zero and the price shall be calculated accordingly (Refer: Additional Instructions to Tenderers Clause no: 24.4 (d)).
3. Unit rates and prices shall be quoted by the Tenderer in Indian Rupees.
4. Where there is a discrepancy between the rate in figures and words, the lower of the two will govern. [ITT Clause 24.1]

PAYMENT TERMS

1. Supply payments: The contractor shall be entitled to be paid against supply of material only for such works as in the opinion of Engineer he has supplied in terms of the contract. All payments shall be subject to deductions. Payments provided always that the engineer may withhold if the works or part thereof are not being carried out to his satisfaction.

2. Contractor shall take prior approval of Engineer-in-charge before supplying of the material along with the approval of makes, drawing and quantity.

Payment procurement of material and progress of work is given below:

i. Procurement of following items shall be as approved by Engineer-in-charge. Payment of 70% of the accepted price shall be paid on the receipt and accountal of material at site or required destination after inspection and production of documents as listed below:

- a. E-way bill.
- b. Supplier's Delivery Challans and supplier's Tax invoice/GST.
- c. Inspection certificate granted by the authorized /approved agency/Purchaser's representative as per contract.
- d. Certificate of receipt of material at Contractor depot/work sites duly accepted by the Engineer.
- e. Quality Assurance Documents including Guarantee/Warrantee, if any.
- f. Insurance certificate of 100% value valid till liability period.
- g. Indemnity bond.

List of items proposed for payment

- a. RCC, PCC and Spun pole.
- b. ACSR conductor of any size.
- c. HT & LT cables of any size.
- d. HT & LT cable end termination kits and cable jointing kits.
- e. Transformers and Compact substations.
- f. All types of RMU units, RTU, LT distribution box,
- g. LT feeder pillar
- j. Metering cubicle, control boxes.

ii. Progress payments against erection of material

On completion of item/work of BOQ, the contractor shall receive payment on submission of bill to the extent of 70% erection costs after making recoveries, if any.

iii. Payment of other items against supply and erection of material.

On completion of each item/work of other items mentioned in BOQ, the contractor shall receive payment on submission of bill to the extent of 70% of the supply and erection costs of other items after making necessary recoveries if any.

(iv). 20% PAYMENT:

The 20% of each item of the BOQ shall be paid to the contractor after erection and testing of the portion of the work. This is applicable for A & B schedules.

(v). 10% PAYMENT:

The Balance 10% of each item of the BOQ shall be paid to the contractor after the EIG Approval and handing over of the installation and released materials to the ESCOM and furnishing the acknowledgment to KRIDE, whichever is later. This is applicable for A & B schedules.

a. Rounding off amounts: The total amount due on each certificate shall be rounded off to the nearest rupee i.e., sum less than 50 paise shall be omitted and sums of 50 paise and more upto Rs.1 will be reckoned as Rs.1.

b. Manner of payment: Unless otherwise specified payments to the contractor will be transferred electronically to his bank account.

c. FINAL SETTLEMENT: On expiry of the defect liability period and issue of the taking over certificate of the entire installation, the Bank Guarantee for Performance security shall be released to the contractor after adjustment of any dues payable by the contractor.

d. RECOVERIES FROM THE CONTRACTOR: All the recoveries for materials supplied and services rendered by KRIDE to the Contractor, if any and other refunds due from the Contractor shall be made by deductions from payments due to the Contractor covering the value of supply and erection in the progress payment.

3. TAXES AND DUTIES:

- i. All taxes, duties and levies (including octroi, works contract tax, GST etc.,) arising out of the transactions between the contractor and his sub-contractor/Suppliers for this work will be deemed to be included in the accepted rates, unless otherwise specified in the BOQ or technical specification.

ii. Where the law makes it statutory for the Purchaser to deduct any amount towards GST or any other taxes on works contract, the same shall be deducted and remitted to the concerned authority.

LIST OF MATERIALS/ APPROVED BRANDS

The make of materials shall be any one of the following approved make or any make having ISI approval / ISI marked or any make / manufacturer having ISO approval.

Sl.no	Description	Make intended to be supplied by the contractor.
1	MCCB / MCB / DB/ RCCB, COS etc	Legrand, L&T, ABB, Schneider, Siemens, C&S, Crompton Greaves Limited, Havells, Anchor, Indo Asian.
2	LT PVC insulated Single & Multicore Wire for Internal Wiring	Polycab, Finolex, Havells, KEI, V-Guard, Anchor, Sbee, Universal, Indo Asian.
3	Cable-Lugs & accessories for electrical general services.	Multi, 3M, Dowells.
4	Light fittings/Lamp	Philips, Bajaj, Crompton Greaves, Havells, Syska, C&S, Wipro.
5	LED make	Nichia, Osram, Seoul, Philips Lumileds, Cree, Lednium, Avago.
6	PVC Rigid Conduit Pipes	Universal, VIP, Sudhakar.
7	Modular Switches, Switch box, Covering plate, Sockets, Holders	Anchor Roma, Havells, Crabtree, Legrand, GM, C&S, Schneider, ABB, Cona, Siemens.
8	Industrial Sockets/ Ray Roll plug and Socket	Legrand, Indo Asian, Schneider, Siemens, Standard, Havells, Indo Asian.
9	Switch fuse unit Single and Three Phase, Change over Switch	Abb, Cgl, Siemens, Indo Asian, Standard, Bch, C&S Schneider, Legrand, Havells, Indo Asian.
10	LT Switch gear and control gears contactors and motor starters	ABB, L&T, Cgl, Siemens, Legrand, Schneider, Havells, Indo Asian.
11	HT Switch gear and control gears	ABB, L&T, Siemens, GE T&D.
12	FRP (Fiberglass Reinforced Plastic) Meter Box.	Sintex Or Hensel.
13	LTUG/ HTUG XLPE cable	Any ESCOM Approved Make with Latest Approval.
14	Jointing Kit-HT/LT	Venus, Denson, Raychem.
15	Automatic switches for Street Light	Any Escom Approved
17	HDPE Pipe	Jindal Pex, Supreme, Finolex, Mangalam.
18	LILO Box/ Meter Box	Schneider, Sintex, Hensel, ABB, Hensel.
19	Multi data Meter	Schneider, ABB, L&T, Elmeasure, Hpl.
20	Microcontroller Timer Control Unit	Bajaj, Philips, Crompton, Siemens, Legrand.
21	Solar Hybrid Emergency Lighting System	Tata or Equivalent.
22	Metering Cubicle	Any ESCOM Approved Make with Latest Approval.
23	Transformer	Any ESCOM Approved with Latest Star

		Rating as Per ESCOM Requirement.
24	CSS	Any ESCOM Approved Make with Latest Approval.
25	RMU	Any ESCOM Approved Make.
26	Feeder Pillar Box	Any ESCOM Approved Make.
27	High Mast	Bajaj, Philips, Crompton Greaves.
28	Insulators	Any ESCOM Approved Make with Latest Approval.
29	HT DOLO FUSE	Any ESCOM Approved Make with Latest Approval.
30	Lightening Arrestor	Any ESCOM Approved Make with Latest Approval.
31	GOS	Any ESCOM Approved Make with Latest Approval.
32	Octagonal Pole/Swaged Pole	Philips, Bajaj, Crompton, Utkarsh Tubes, Jindal.
33	MS/GI Tubular Poles	Jindal, Tata.
34	GI Pipe Class B	Jindal, Tata.
35	Indoor outdoor Potheads for HT cable	Any ESCOM Approved Make.
36	Spun Pole, PSCC Pole, RCC pole	Any ESCOM Approved Vendor.

NOTE:

1. Products Certified by the Bureau of Indian Standards and Provided with ISI Mark are only acceptable. The Contractor must obtain a specific approval of engineer in charge in writing prior to using of any substitute make not mentioned in the list above or in case make without ISI or BIS standard are to be supplied.
2. Raw materials of fabricated products like Steel poles should be tested at approved test laboratory and certificate should be furnished by the contractor. Materials, welding, galvanizing etc., shall conform to IS specifications latest. DP test should be carried out on all the seam as per IS: 3658:1999 or latest.
3. Successful tenderer should obtain relevant approved ESCOM specification for Transformers (if supply of Tr. is involved) with endorsement of acceptance for Execution of work at respective location.
4. The successful tender shall obtain design drawings of CSS, RMU, LT/HT Switchgears and LT/HT panels prior to supply of items at the site of work.
5. Before supply of the materials without approval of makes/models no supply shall be accepted
6. Approval shall be obtained from **JGM/K-RIDE**

SECTION-10

FORMAT OF BANK GUARANTEE FOR SECURITY DEPOSIT ETC.,

INDEX

Table of Forms

SL. NO	DESCRIPTION	PAGE NO
1	FORMAT OF BANK GUARANTEE FOR SECURITY DEPOSIT	498
2	FORM OF BANK GUARANTEE FOR PERFORMANCE SECURITY	499-501
3	FORM OF BANK GUARANTEE FOR ADDITIONAL PERFORMANCE SECURITY	502-504
4	ADVANCE PAYMENT SECURITY	505-508
5	INDEMNITY BOND FOR THE SAFE CUSTODY OF THE MATERIALS SUPPLIED BY THE CONTRACTOR	509-512

NOTE: *This Section contains forms which, once completed, will form part of the Contract. The forms for Performance Security and Advance Payment Security, when required, shall only be completed by the successful Bidder after contract award.*

All italicized text is for guidance how to prepare the various forms and shall be deleted from the final documents.

FORMAT OF BANK GUARANTEE FOR SECURITY DEPOSIT

To..... (Name of the Employer)
..... (Address of the Employer).

Whereas (Name and Address of the contractor) (herein after called the Contractor) has undertaken, in pursuance of contract no..... Dated:.....(Name of the contract and brief description of the work) (herein after called the Contract)

AND WHEREAS it has been stipulated by you in the said Contract that the Contractor shall furnish you with a Bank Guarantee by a recognized bank for the sum specified therein as security for compliance with his obligations in accordance with the Contract;

AND WHEREAS we have agreed to give the Contractor such a Bank Guarantee;

NOW THEREFORE we hereby affirm that we are the Guarantor and responsible to you, on behalf of the Contractor, up to a total of Rs. _____ [amount of guarantee] Rupees _____ [in words], and we undertake to pay you, upon your first written demand and without cavil or argument, any sum or sums within the limits of _____ [amount of guarantee] as aforesaid without your needing to prove or to show grounds or reasons for your demand for the sum specified therein.

We hereby waive the necessity of your demanding the said debt from the Contractor before presenting us with the demand.

We further agree that no change or addition to or other modification of the terms of the Contract or of the Works to be performed there under or of any of the Contract documents which may be made between you and the Contractor shall in any way release us from any liability under this guarantee, and we hereby waive notice of any such change, addition or modification.

This guarantee shall be valid until 28 days from the date of expiry of the Defects Liability Period.

Signature and seal of the guarantor _____
Name of Bank _____
Address _____
Date _____

FORM OF BANK GUARANTEE FOR PERFORMANCE SECURITY

(On non-judicial stamp paper of the appropriate value in accordance with stamp Act. The stamp paper to be in the name of Executing Bank).

From:

Name and Address of the Bank.....

To:

The Managing Director,
 Rail Infrastructure Development Company (Karnataka) Limited,
 "Samparka Soudha" , 1st Floor,
 B.E.P Premises (Opp. Orion Mall),
 Dr. Rajkumar Road,
 Rajajinagar 1st Block,
 Bangalore - 560 010

WHEREAS, Rail Infrastructure Development Company (Karnataka) Limited, hereinafter called the **Employer**, acting through **[Insert Designation and address of the Employer's Representative]**, has accepted the bid of **[Insert Name and address of the Contractor]**, hereinafter called the **Contractor**, for the work of **[Insert Name of Work]**, vide Notification of Award No **[Insert Notification of Award No...]**
AND

WHEREAS, the contractor is required to furnish Performance Security for the sum of **[Insert Value of Performance Security required]**, in the form of bank guarantee, being a condition precedent to the signing of the contract agreement.

WHEREAS, **[Insert Name of the Bank]**, with its Branch **[Address]** having its Headquarters office at **[Address]**, hereinafter called the **Bank**, acting through **[Designation(s) of the authorised person of the Bank]**, have, at the request of the **[Insert name of the JV partner]**, a JV partner on behalf of the contractor, agreed to give guarantee for performance security and additional performance security as hereinafter contained:

- 1 KNOW ALL MEN by these present that I/We the undersigned **[Insert name(s) of authorized representatives of the Bank]**, being fully authorized to sign and incur obligations for and on behalf of the Bank, confirm that the Bank, hereby, unconditionally and irrevocably guarantee to pay the Employer the full amount in the sum of **[Insert Value of Performance Security required]** as above stated.
- 2 The Bank undertakes to immediately pay on presentation of demand by the Employer any amount up to and including aforementioned full amount without any demur, reservation or recourse. Any such demand made by the Employer on the Bank shall be final, conclusive and binding, absolute and unequivocal not withstanding any disputes raised/ pending before any Court, Tribunal, Arbitration or any Authority or any threatened litigation by the Employer of Bank.

- 3 On payment of any amount less than aforementioned full amount, as per demand of the Employer, the guarantee shall remain valid for the balance amount i.e. the aforementioned full amount less the payment made to the Employer.
- 4 The Bank shall pay the amount as demanded immediately on presentation of the demand by Employer without any reference to the contractor and without the Employer being required to show grounds or give reasons for its demand or the amount demanded.
- 5 The Bank Guarantee shall be unconditional and irrevocable.
- 6 The guarantee hereinbefore shall not be affected by any change in the constitution of the Bank or in the constitution of the Contractor.
- 7 The Bank agrees that no change, addition, modifications to the terms of the Contract Agreement or to any documents, which have been or may be made between the Employer and the Contractor, will in any way release us from the liability under this guarantee; and the Bank, hereby, waives any requirement for notice of any such change, addition or modification to the Bank.
- 8 This guarantee is valid and effective from the date of its issue, which is **[insert date of issue]**. The guarantee and our obligations under it will expire **on [Insert the date Sixty days after the expected date of completion of work]**. All demands for payment under the guarantee must be received by us on or before that date.
- 9 The Bank agrees that the Employers right to demand payment of aforementioned full amount in one instance or demand payments in parts totaling up to the aforementioned full amount in several instances will be valid until either the aforementioned full amount is paid to the Employer or the guarantee is released by Employer before the Expiry date.
- 10 The Bank agrees that its obligation to pay any amount demanded by the Employer before the expiry of this guarantee will continue until the amount demanded has been paid in full.
- 11 The expressions Bank and Employer herein before used shall include their respective successors and assigns.
- 12 The Bank hereby undertakes not to revoke the guarantee during its currency, except with the previous consent in writing of the employer. This guarantee is subject to the Uniform Rules for Demand Guarantees, ICC Publication No. 758.
- 13 The Guarantee shall be in addition to and without prejudice to any other security Guarantee (s) of the contractor in favor of the Employer available with the Employer. The Bank, under this Guarantee, shall be deemed as Principal Debtor of the Employer.

14. This guarantee shall be valid for 60 days after the date of completion of work.

Date

Place.....

.....

[Signature of Authorized person of
Bank/Guarantor]

.....
[Name in Block letters]

.....
[Designation]

.....
[P/Attorney] No.

.....
Bank's Name and Seal

[P/Attorney] No.....

Witness:

1. *Signature*
Name & Address & Seal

2. *Signature*
Name & address & Seal

Note :

1. *All italicized text is for guidance on how to prepare this bank guarantee and shall be deleted from the final document.*
2. *In case the guarantee is issued by a foreign Bank, which does not have operations in India, the said bank shall have to provide a counter-guarantee by State Bank of India.*
3. *In case the Contractor is a JV, the Performance Security is required to be furnished on behalf of the JV in favour of the Employer by the JV Partners in proportion of their respective percentage share specified in the JV Agreement. The percentage share of M/s [Insert Name of the JV Partner] in the JV is [Fill share % in the JV] percent. All the Bank Guarantee of JV Partners are liable to be encashed cumulatively.*

FORM OF BANK GUARANTEE FOR ADDITIONAL PERFORMANCE SECURITY

(On non-judicial stamp paper of the appropriate value in accordance with stamp Act. The stamp paper to be in the name of Executing Bank)

From:

Name and Address of the Bank.....
.....

To:

The Managing Director,
Rail Infrastructure Development Company (Karnataka) Limited,
"Samparka Soudha" , 1st Floor,
B.E.P Premises (Opp. Orion Mall),
Dr. Rajkumar Road,
Rajajinagar 1st Block,
Bangalore - 560 010

WHEREAS, Rail Infrastructure Development Company (Karnataka) Limited, hereinafter called the **Employer**, acting through **[Insert Designation and address of the Employer's Representative]**, has accepted the bid of **[Insert Name and address of the Contractor]**, hereinafter called the **Contractor**, for the work of **[Insert Name of Work]**, vide Notification of Award No. **[Insert Notification of Award No.]**.
AND

WHEREAS, the contractor is required to furnish Performance Security for the sum of **[Insert Value of Performance Security required]**, in the form of bank guarantee, being a condition precedent to the signing of the contract agreement.

WHEREAS, **[Insert Name of the Bank]**, with its Branch **[Address]** having its Headquarters office at **[Address]**, hereinafter called the **Bank**, acting through **[Designation(s) of the authorised person of the Bank]**, have, at the request of the **[Insert name of the JV partner]**, a JV partner on behalf of the contractor, agreed to give guarantee for performance security and additional performance security as hereinafter contained:

- 1 KNOW ALL MEN by these present that I/We the undersigned **[Insert name(s) of authorized representatives of the Bank]**, being fully authorized to sign and incur obligations for and on behalf of the Bank, confirm that the Bank, hereby, unconditionally and irrevocably guarantee to pay the Employer the full amount in the sum of **[Insert Value of Performance Security required]** as above stated.
- 2 The Bank undertakes to immediately pay on presentation of demand by the Employer any amount up to and including aforementioned full amount without any demur, reservation or recourse. Any

such demand made by the Employer on the Bank shall be final, conclusive and binding, absolute and unequivocal notwithstanding any disputes raised/ pending before any Court, Tribunal, Arbitration or any Authority or any threatened litigation by the Employer of Bank..

- 3 On payment of any amount less than aforementioned full amount, as per demand of the Employer, the guarantee shall remain valid for the balance amount i.e. the aforementioned full amount less the payment made to the Employer.
- 4 The Bank shall pay the amount as demanded immediately on presentation of the demand by Employer without any reference to the contractor and without the Employer being required to show grounds or give reasons for its demand or the amount demanded.
- 5 The Bank Guarantee shall be unconditional and irrevocable.
- 6 The guarantee hereinbefore shall not be affected by any change in the constitution of the Bank or in the constitution of the Contractor.
- 7 The Bank agrees that no change, addition, modifications to the terms of the Contract Agreement or to any documents, which have been or may be made between the Employer and the Contractor, will in any way release us from the liability under this guarantee; and the Bank, hereby, waives any requirement for notice of any such change, addition or modification to the Bank.
- 8 This guarantee is valid and effective from the date of its issue, which is ***[insert date of issue]***. The guarantee and our obligations under it will expire on ***[Insert the date twenty-eight days after the expected end of defect liability period]***. All demands for payment under the guarantee must be received by us on or before that date.
- 9 The Bank agrees that the Employers right to demand payment of aforementioned full amount in one instance or demand payments in parts totaling up to the aforementioned full amount in several instances will be valid until either the aforementioned full amount is paid to the Employer or the guarantee is released by Employer before the Expiry date.
- 10 The Bank agrees that its obligation to pay any amount demanded by the Employer before the expiry of this guarantee will continue until the amount demanded has been paid in full.
- 11 The expressions Bank and Employer herein before used shall include their respective successors and assigns.
- 12 The Bank hereby undertakes not to revoke the guarantee during its currency, except with the previous consent in writing of the employer. This guarantee is subject to the Uniform Rules for Demand Guarantees, ICC Publication No. 758.
- 13 The Guarantee shall be in addition to and without prejudice to any other security Guarantee (s) of the contractor in favour of the Employer available with the Employer. The Bank, under this Guarantee, shall be deemed as Principal Debtor of the Employer.

Date
Place.....

.....
[Signature of Authorised person of Bank]

.....
[Name in Block letters]

.....
[Designation]

.....
[P/Attorney] No.

.....
Bank's Seal

[P/Attorney] No.....
Witness:

3. *Signature*
Name & Address & Seal
4. *Signature*
Name & address & Seal

Note :

- 1 *All italicized text is for guidance on how to prepare this bank guarantee and shall be deleted from the final document.*
- 2 *In case the guarantee is issued by a foreign Bank, which does not have operations in India, the said bank shall have to provide a counter-guarantee by State Bank of India.*
- 3 *In case the Contractor is a JV, the Performance Security is required to be furnished on behalf of the JV in favour of the Employer by the JV Partners in proportion of their respective percentage share specified in the JV Agreement. The percentage share of M/s **[Insert Name of the JV Partner]** in the JV is **[Fill share % in the JV]** percent. All the Bank Guarantee of JV Partners are liable to be encashed cumulatively.*

ADVANCE PAYMENT SECURITY

(On non-judicial stamp paper of appropriate value in accordance with stamp Act. The stamp paper to be in the name of Executing Bank)

From

[Name and Address of the Bank]

To

The Managing Director,
Rail Infrastructure Development Company (Karnataka) Limited,
"Samparka Soudha", 1st Floor,
B.E.P Premises (Opp. Orion Mall),
Dr. Rajkumar Road,
Rajajinagar 1st Block,
Bangalore - 560 010

Beneficiary/Employer: Rail Infrastructure Development Company (Karnataka) Limited.

Guarantee No.: *[.....reference number of the guarantee.....]* **Dated:** *[.....]*

WHEREAS, Rail Infrastructure Development Company (Karnataka) Limited (**hereinafter called the Employer**) has entered into Contract No. *[.....reference number of the Contract.....]* dated *[.....]* for the execution of *[name of the contract]* (**hereinafter called the Contract**) with *[.....name of the Contractor.....]* (**hereinafter called the Contractor**).

WHEREAS, according to the Conditions of the Contract, an advance payment is admissible to the contractor against submission of bank guarantee(s).

At the request of the Contractor, we *[.....name of the Bank.....]* with our branch at *[.....address.....]*, having our Head Office at *[.....address.....]* (**hereinafter called the Bank**) have, at the request of *[.....Insert name of the JV partner.....]*, a JV partner on behalf of the Contractor, agreed to give the said guarantee as hereinafter contained:

1. KNOW ALL MEN by these present that I/We the undersigned *[.....Insert name(s) of authorized representative(s) of the Bank.....]*, being fully authorized to sign and incur obligations for and on behalf of the Bank, confirm that the Bank, hereby, unconditionally and irrevocably guarantees

to pay the Employer the sum of Rs.[...value in figure...](Rupees [...value in words...]
only(**hereinafter called the Full Amount**).

2. The Bank undertakes to immediately pay to the Employer, without any demur, reservation or recourse, any amount up to and including aforementioned full amount upon first written demand/demands from the Employer.
3. On payment of any amount less than aforementioned full amount, as per demand of the Employer, the guarantee shall remain valid for the balance amount i.e. the aforementioned full amount less the payment made to the Employer.
4. The Bank shall pay the amount so demanded without any reference to the contractor and without the Employer being required to show grounds or give reasons for its demand or the amount demanded.
5. The guarantee hereinbefore shall not be affected by any change in the constitution of the Bank, the Contractor or the Employer.
6. The Bank agrees that no change, addition, modification to the terms of the Contract Agreement or to any document, which have been or may be made between the Employer and the Contractor, will in any way release us from the liability under this guarantee; and the Bank, hereby, waives any requirement for notice of any such change, addition or modification to the Bank.
7. This guarantee is valid and effective from the date of it's issue, which is [...date of issue...]. The guarantee and our obligations under it will expire on dated[...Please refer note 4 & 5...]. All demands for payment under the guarantee must be received by us on or before that date.
8. The Bank agrees that the Employer's right to demand payment of aforementioned full amount in one instance or demand payments in parts totaling up to the aforementioned full amount in several instances will continue until either the aforementioned full amount is paid to the Employer or the guarantee validity period expires.
9. The Bank agrees that it's obligation to pay any amount demanded by the Employer before the expiry of this guarantee will continue until the amount demanded has been paid in full.
10. The expressions Bank and Employer herein before used shall include their respective successors and assigns.

11. The Bank hereby undertakes not to revoke the guarantee during its currency, except with the previous consent in writing of the employer. This guarantee is subject to the Uniform Rules for Demand Guarantees, ICC Publication No. 758.

Dated[.....]

Place[.....]

.....
(Signature of the Authorized Person of the Bank)

.....
(Name in Block Letters)

.....
(Designation)

.....
(Bank's Seal)

.....
(Authorization No.)

Witness:

1.
Signature, Name & Address

2.
Signature, Name & Address

Note:

1. *All italicized text in brackets [....text....] is for guidance on how to prepare this bank guarantee and shall be deleted from the final document.*
2. *In case the guarantee is issued by a foreign Bank, the said bank shall have operations in India and should be issued by Indian operations branch of the said bank.*

3. **Mobilization Advance**

(a) For Single Entity

For each Installment of Advance, two Bank Guarantees of equal amounts (each equal to half of the first installment of advance plus 10%) shall be furnished. Each Bank Guarantee shall be valid for the stipulated completion period of the contract.

OR

(b) For JV/Consortium

For each Installment of Advance, individual JV/Consortium partner shall furnish Bank Guarantee equal to his share in the installment of Advance plus 10%. Each Bank Guarantee shall be valid for the stipulated completion period of the contract.

4. **Advance against Plant and Machinery**

(a) For Single Entity

For each Installment of Advance, a Bank Guarantee equal to the installment of advance plus 10% shall be furnished. The Bank Guarantee shall be valid for the stipulated completion period of the contract.

OR

(b) For JV/Consortium

For each Installment of Advance, individual JV/Consortium partner shall furnish a Bank Guarantee equal to his share in the installment of advance plus 10%. Each Bank Guarantee shall be valid for the stipulated completion period of the contract.

**INDEMNITY BOND FOR THE SAFE CUSTODY OF THE
MATERIALS SUPPLIED BY THE CONTRACTOR**

(To be executed on Non-Judicial Stamp Paper of Appropriate Value and
notarized)

THIS INDEMNITY BOND made on this _____ day of _____ 20__ by _____ (*insert the name of the Contractor and its registered address*) (hereinafter called "the Contractor") which expression shall where the context do admits or implies be deemed to include its executors, administrators and assigns, in favour of the Rail Infrastructure Development Company (Karnataka) Limited, Samparka Soudha" ,
1st Floor, B.E.P Premises (Opp. Orion Mall), Dr. Rajkumar Road, Rajajinagar 1st Block, Bangalore - 560 010 (hereinafter called "K RIDE") on the other part.

WHEREAS by an Agreement/Letter of Acceptance No. _____ dated _____ (hereinafter called "the said agreement"), the Contractor has agreed to execute the _____ (*Name of Work*) (hereinafter called "the Works") .

AND WHEREAS the Contractor has submitted to K RIDE/ the Engineer for payment on materials procured by him and brought to the site of the Works or his workshop for use in the Works.

AND WHEREAS K RIDE/ the Engineer has agreed to make advance/stage payment to the Contractor the total sum of Rs. _____ (*in Figures*) [Rupees _____ (*in Words*)] in Interim Payment Certificate (IPC) No. _____, the quantities and other particulars of which are detailed in this IPC for the said works signed by the Contractor on _____ for the Materials brought by the Contractor to site of the works. Brief details are also mentioned in schedule 1 appended hereto.

NOW THIS INDEMNITY BOND WITNESS that in pursuance of the said agreement and in consideration of the sum of Rs. _____ (*in Figures*) _____ (*in Words*) on or before the execution of these presents to be paid to the Contractor by K RIDE so aforesaid, the Contractor doth hereby covenant and agree with K RIDE and declare as follows: -

1. That the said sum of Rs. _____ (*In Figures*) _____ (*in Words*) to be paid by K RIDE to the Contractor as aforesaid shall be utilized by the Contractor in or towards the execution of the said works and for no other purpose whatsoever.
2. That the Materials detailed in the said IPC which have been offered to and accepted by K RIDE/ the Engineer, are absolutely the Contractor's own property and free from encumbrances of any kind and the Contractor will not make any application for or receive any further payment on the Materials which are not absolutely his own property and free from encumbrances of any kind, the Contractor indemnifies the K RIDE against all claims on any Materials in respect of which payment is to be made to him as aforesaid.
3. That the Contractor undertakes that the Materials shall be used exclusively for the performance / execution of the Contract strictly in accordance with the terms and conditions of the Contract and no part of the Materials shall be utilized for any other work or purpose whatsoever.

4. That the Contractor is obliged and shall remain absolutely responsible for the safe transit / protection and custody of the Materials against all risks whatsoever including acts of the God till the Materials are duly incorporated in the works, commissioned and are taken over by K RIDE/Railway (including surplus Materials, if required as instructed by K RIDE/ the Engineer) in accordance with the terms of the Contract. The Contractor undertakes to keep K RIDE harmless against any loss or damage that may be caused to the Materials.
5. That the said Materials shall not on any account be removed from the site of the works except with the written permission of K RIDE/ the Engineer. Further, K RIDE/ the Engineer shall always be free at all times to take possession of the materials in whatever form the materials may be in, if in its opinion, the Materials are likely to be endangered, mis-utilized or converted to uses other than those specified in the Contract, by any acts or omission or commission on the part of the Contractor or any other person or on account of any reason whatsoever and the Contractor binds himself and undertakes to comply with the directions of demand of K RIDE to return the Materials without any demur or reservation.
6. That the said materials shall, at all times, be open to inspection by K RIDE/ the Engineer or any authorized representative. In the event of the said material or any part thereof at any time being found to be in lesser quantity than for which payment has been released or the same has been stolen, destroyed or damaged or becoming deteriorated, the Contractor will forthwith replace the same or repair and make good the same as required by K RIDE/ the Engineer.
7. That making payment does not mean that Materials are of required specifications and quality or that whole of the quantity brought to site by Contractor will be used in the work. The Contractor is fully responsible for the materials to conform to required quality and specification and if at any time K RIDE/ the Engineer do not find the material satisfactory, the Contractor at his own cost would replace these. K RIDE/ the Engineer would be at liberty to recover cost of these from any dues of the Contractor. Also any Materials which are in excess of what is finally required under the contract would be the Contractor's property without any liability on K RIDE/ the Engineer who would recover the cost of this from the Contractor.
8. That this INDEMNITY BOND is irrevocable. If at any time, any loss or damage occurs to the Materials or the same or any part thereof is mis-utilized in any manner whatsoever, then the Contractor hereby agrees that the decision of K RIDE/ the Engineer as to assessment of loss or damage to the Materials shall be final and binding on the Contractor. The Contractor binds itself and undertakes to replace the lost and/or damaged Materials at its own cost and/or shall pay the amount of loss to K RIDE without any demur, reservation or protest. This is without prejudice to any other right or remedy that may be available to K RIDE/ the Engineer against the Contractor under the Contract or under this Indemnity Bond
9. That if the Contractor shall at any time make any default in the performance or observance in any respect of any of the terms and provisions of the said agreement or of those presents, the total amount of the payment shall immediately on the happening of such default be recovered by K RIDE/ the Engineer from any dues of Contractor. It is also clearly understood by the Contractor that non-

observance of the obligations under this Indemnity Bond by the Contractor shall inter-alia constitute a criminal breach of trust on the part of the Contractor for all intents and purpose including legal / penal consequences.

10. IN WITNESS WHEREOF, the Contractor has hereunto set its hand through its authorized representative, the day, month and year first above mentioned.

11. SCHEDULE 1

Particulars of the Materials	Quantity	Value of the Materials

Signed, Sealed and Delivered by the said Contractor

(Contractor's Name)

Dated:

(AUTHORISED SIGNATORY)

Place:

SEAL OF COMPANY



IN THE PRESENCE OF:

WITNESS: SIGNATURE _____

NAME: _____

ADDRESS : _____

Note:

The contractor has the option to submit the INDEMNITY BOND to cover all the items and quantities of Materials of stage payment or to submit INDEMNITY BOND each time the stage payment is to be taken or Materials advance is to be taken.

No.

Office of the.....

Date:.....

--00--00--00--

K-RIDE